

# NFPA® 30

## Flammable and Combustible Liquids Code

### 2015 Edition



NFPA, 1 Batterymarch Park, Quincy, MA 02169-7471  
An International Codes and Standards Organization

## IMPORTANT NOTICES AND DISCLAIMERS CONCERNING NFPA® STANDARDS

### NOTICE AND DISCLAIMER OF LIABILITY CONCERNING THE USE OF NFPA STANDARDS

NFPA® codes, standards, recommended practices, and guides (“NFPA Standards”), of which the document contained herein is one, are developed through a consensus standards development process approved by the American National Standards Institute. This process brings together volunteers representing varied viewpoints and interests to achieve consensus on fire and other safety issues. While the NFPA administers the process and establishes rules to promote fairness in the development of consensus, it does not independently test, evaluate, or verify the accuracy of any information or the soundness of any judgments contained in NFPA Standards.

The NFPA disclaims liability for any personal injury, property or other damages of any nature whatsoever, whether special, indirect, consequential or compensatory, directly or indirectly resulting from the publication, use of, or reliance on NFPA Standards. The NFPA also makes no guaranty or warranty as to the accuracy or completeness of any information published herein.

In issuing and making NFPA Standards available, the NFPA is not undertaking to render professional or other services for or on behalf of any person or entity. Nor is the NFPA undertaking to perform any duty owed by any person or entity to someone else. Anyone using this document should rely on his or her own independent judgment or, as appropriate, seek the advice of a competent professional in determining the exercise of reasonable care in any given circumstances.

The NFPA has no power, nor does it undertake, to police or enforce compliance with the contents of NFPA Standards. Nor does the NFPA list, certify, test, or inspect products, designs, or installations for compliance with this document. Any certification or other statement of compliance with the requirements of this document shall not be attributable to the NFPA and is solely the responsibility of the certifier or maker of the statement.

#### REMINDER: UPDATING OF NFPA STANDARDS

Users of NFPA codes, standards, recommended practices, and guides (“NFPA Standards”) should be aware that NFPA Standards may be amended from time to time through the issuance of Tentative Interim Amendments or corrected by Errata. An official NFPA Standard at any point in time consists of the current edition of the document together with any Tentative Interim Amendment and any Errata then in effect.

In order to determine whether an NFPA Standard has been amended through the issuance of Tentative Interim Amendments or corrected by Errata, visit the Document Information Pages on NFPA’s website. The Document Information Pages provide up-to-date, document specific information including any issued Tentative Interim Amendments and Errata.

To access the Document Information Page for a specific NFPA Standard, go to <http://www.nfpa.org/docinfo> to choose from the list of NFPA Standards or use the search feature on the right to select the NFPA Standard number (e.g., NFPA 101). In addition to posting all existing Tentative Interim Amendments and Errata, the Document Information Page also includes the option to sign-up for an “Alert” feature to receive an email notification when new updates and other information are posted regarding the document.

ADDITIONAL NOTICES AND DISCLAIMERS

**Updating of NFPA Standards**

Users of NFPA codes, standards, recommended practices, and guides (“NFPA Standards”) should be aware that these documents may be superseded at any time by the issuance of new editions or may be amended from time to time through the issuance of Tentative Interim Amendments or corrected by Errata. An official NFPA Standard at any point in time consists of the current edition of the document together with any Tentative Interim Amendments and any Errata then in effect. In order to determine whether a given document is the current edition and whether it has been amended through the issuance of Tentative Interim Amendments or corrected through the issuance of Errata, consult appropriate NFPA publications such as the National Fire Codes® Subscription Service, visit the NFPA website at [www.nfpa.org](http://www.nfpa.org), or contact the NFPA at the address listed below.

**Interpretations of NFPA Standards**

A statement, written or oral, that is not processed in accordance with Section 6 of the Regulations Governing the Development of NFPA Standards shall not be considered the official position of NFPA or any of its Committees and shall not be considered to be, nor be relied upon as, a Formal Interpretation.

**Patents**

The NFPA does not take any position with respect to the validity of any patent rights referenced in, related to, or asserted in connection with an NFPA Standard. The users of NFPA Standards bear the sole responsibility for determining the validity of any such patent rights, as well as the risk of infringement of such rights, and the NFPA disclaims liability for the infringement of any patent resulting from the use of or reliance on NFPA Standards.

NFPA adheres to the policy of the American National Standards Institute (ANSI) regarding the inclusion of patents in American National Standards (“the ANSI Patent Policy”), and hereby gives the following notice pursuant to that policy:

**NOTICE:** The user’s attention is called to the possibility that compliance with an NFPA Standard may require use of an invention covered by patent rights. NFPA takes no position as to the validity of any such patent rights or as to whether such patent rights constitute or include essential patent claims under the ANSI Patent Policy. If, in connection with the ANSI Patent Policy, a patent holder has filed a statement of willingness to grant licenses under these rights on reasonable and nondiscriminatory terms and conditions to applicants desiring to obtain such a license, copies of such filed statements can be obtained, on request, from NFPA. For further information, contact the NFPA at the address listed below.

**Law and Regulations**

Users of NFPA Standards should consult applicable federal, state, and local laws and regulations. NFPA does not, by the publication of its codes, standards, recommended practices, and guides, intend to urge action that is not in compliance with applicable laws, and these documents may not be construed as doing so.

**Copyrights**

NFPA Standards are copyrighted. They are made available for a wide variety of both public and private uses. These include both use, by reference, in laws and regulations, and use in private self-regulation, standardization, and the promotion of safe practices and methods. By making these documents available for use and adoption by public authorities and private users, the NFPA does not waive any rights in copyright to these documents.

Use of NFPA Standards for regulatory purposes should be accomplished through adoption by reference. The term “adoption by reference” means the citing of title, edition, and publishing information only. Any deletions, additions, and changes desired by the adopting authority should be noted separately in the adopting instrument. In order to assist NFPA in following the uses made of its documents, adopting authorities are requested to notify the NFPA (Attention: Secretary, Standards Council) in writing of such use. For technical assistance and questions concerning adoption of NFPA Standards, contact NFPA at the address below.

**For Further Information**

All questions or other communications relating to NFPA Standards and all requests for information on NFPA procedures governing its codes and standards development process, including information on the procedures for requesting Formal Interpretations, for proposing Tentative Interim Amendments, and for proposing revisions to NFPA standards during regular revision cycles, should be sent to NFPA headquarters, addressed to the attention of the Secretary, Standards Council, NFPA, 1 Batterymarch Park, P.O. Box 9101, Quincy, MA 02269-9101; email: [stds\\_admin@nfpa.org](mailto:stds_admin@nfpa.org)

For more information about NFPA, visit the NFPA website at [www.nfpa.org](http://www.nfpa.org). All NFPA codes and standards can be viewed at no cost at [www.nfpa.org/freeaccess](http://www.nfpa.org/freeaccess).

Copyright © 2014 National Fire Protection Association®. All Rights Reserved.

## NFPA® 30

# Flammable and Combustible Liquids Code

### 2015 Edition

This edition of NFPA 30, *Flammable and Combustible Liquids Code*, was prepared by the Technical Committee on Fundamentals, the Technical Committee on Operations, the Technical Committee on Storage and Warehousing of Containers and Portable Tanks, and the Technical Committee on Tank Storage and Piping Systems and released by the Correlating Committee on Flammable and Combustible Liquids. It was issued by the Standards Council on April 29, 2014, with an effective date of May 19, 2014, and supersedes all previous editions.

This edition of NFPA 30 was approved as an American National Standard on May 19, 2014.

### Origin and Development of NFPA 30

From 1913 to 1957, this document was written as a model municipal ordinance known as the *Suggested Ordinance for the Storage, Handling, and Use of Flammable Liquids*. In 1957, the format was changed to a code, although the technical requirements and provisions remained the same. Since its inception numerous revised editions have been published as dictated by experience and advances in technology.

A brief review of the major changes adopted since 1981 follows. In 1984, the chapter on automotive and marine service stations was removed from NFPA 30 and was replaced with a new document, NFPA 30A, *Automotive and Marine Service Station Code*, now titled *Code for Motor Fuel Dispensing Facilities and Repair Garages*. In 1987, Chapter 5 (Industrial Plants), Chapter 6 (Bulk Plants and Terminals), Chapter 7 (Process Plants), and Chapter 8 (Refineries, Chemical Plants, and Distilleries) were combined into a single chapter on operations. In 1990, a new section was added to address hazardous materials storage lockers, and more detailed guidance was added to address ventilation of enclosed process areas and for estimation of fugitive emissions. In 1993, the chapter on tank storage was amended to allow combined remote impounding and diking systems and to provide relief from the spill control requirements for certain secondary containment-type tanks. Also, the chapter on container and portable tank storage was completely rewritten so that its requirements were presented more clearly, especially for mercantile occupancies.

In 1996, the following major changes were incorporated: requirements for temporary and permanent closure of underground storage tanks; requirements for tightness testing of tanks of specific design; recognition of intermediate bulk containers; and mandatory fire protection design criteria for inside storage of liquids in storage rooms and liquid warehouses.

In 2000, the following major changes were incorporated: complete editorial rewrites of Chapter 2, Tank Storage, and Chapter 3, Piping Systems; requirements for vaults for aboveground tanks and for protected aboveground tanks; recognition of certain nonmetallic intermediate bulk containers for storage of Class II and Class III liquids, along with fire protection system design criteria for them; simplified spill containment and drainage requirements; new fire protection design criteria for a number of flammable and combustible liquid commodities; expansion of the requirements for construction and separation of process buildings; a new section addressing recirculating heat transfer fluid heating systems; a new section addressing solvent recovery distillation units; and consolidation of all requirements for hazardous location electrical area classification into a single chapter.

The 2003 edition of NFPA 30 incorporated the following changes:

- (1) Numerous occupancy definitions were either added or corrected to correlate with NFPA 1, *Uniform Fire Code*™; NFPA 101®, *Life Safety Code*®; and NFPA 5000®, *Building Construction and Safety Code*®.
- (2) Separation distance requirements for protected aboveground tanks were reduced, and separation distance requirements for tanks in vaults were eliminated.
- (3) Special operating requirements were added for shop-fabricated aboveground tanks with abnormally long vertical piping for fill and/or vent lines.

- (4) New criteria were added to Chapter 6, Container and Portable Tank Storage, for maximum allowable capacities of acceptable container sizes.
- (5) Fire protection design criteria for unsaturated polyester resins were added.
- (6) Section D.5, Recommended Fire Protection Design Criteria for High-Expansion Foam Fire Protection for Non-miscible Liquids, was added.
- (7) Revisions were made to the spacing requirements and construction requirements for process buildings.
- (8) Special requirements were added for insulated piping for recirculating heat transfer systems.
- (9) Permanent interconnections between fire water systems and process water systems were prohibited.

The 2008 edition of NFPA 30 incorporated a complete editorial revision of the prior edition to implement NFPA's hazardous materials template, a formatting scheme intended to integrate a common organization and common outline for all NFPA codes and standards that address the various types of hazardous materials. As a result of the implementation of the template, the eight chapters that the 2003 edition of NFPA 30 comprised were subdivided and rearranged into 29 shorter, more narrowly focused chapters. Requirements that are generally applicable to all facilities that store, handle, and use flammable and combustible liquids were relocated to the beginning of the code. Chapters dealing with bulk storage and bulk handling of liquids were moved to the end of the code, based on the reasoning that not all codes and standards dealing with hazardous materials include provisions for bulk storage.

In addition to the editorial revision, the 2008 edition of NFPA 30 incorporated the following technical changes:

- (1) Several new definitions were added to assist the user in applying the requirements of the code. Some existing definitions in Chapter 3 were changed to read the same as the preferred definitions in the NFPA *Glossary of Terms*. Where possible, secondary definitions were moved to appropriate chapters.
- (2) Chapter 6, Container and Portable Tank Storage, was replaced by Chapters 9 through 16 of the 2008 edition. These new chapters regulated storage of containers, portable tanks, and intermediate bulk containers in a manner that is consistent with model building codes, such as NFPA 5000<sup>®</sup>, *Building Construction and Safety Code*<sup>®</sup>, and model fire prevention codes, such as NFPA 1, *Uniform Fire Code*<sup>™</sup>, and incorporated the concepts of maximum allowable quantities (MAQs), control areas, and protection levels.
- (3) Fire protection design criteria for inside storage areas were expanded to include requirements for small plastic containers of Class IB, IC, II, and III liquids in corrugated cartons and for Class IIIB liquids in corrugated cardboard intermediate bulk containers with plastic inner liners. The flowcharts and tables that contain these design criteria were reformatted to present the information more consistently.
- (4) New corrosion protection requirements were added for nonmetallic tanks.
- (5) New requirements for periodic testing, maintenance, inspection, and repair of aboveground storage tanks were added.
- (6) Overfill prevention requirements were revised so that they apply to all tanks larger than 1320 gal (5000 L) capacity.
- (7) Additional requirements for fire-resistant tanks were added.
- (8) The maximum capacity for secondary containment-type tanks storing Class II and Class IIIA liquids was increased from 12,000 gal (45,000 L) to 20,000 gal (76,000 L).
- (9) The requirements for construction of storage tank vaults were improved for clarity.
- (10) Special requirements for marine piping systems were added.

The 2012 edition of NFPA 30 incorporated the following technical changes:

- (1) Use and installation of alcohol-based hand rub dispensers were exempted from the code.
- (2) NFPA 20, *Standard for the Installation of Stationary Pumps for Fire Protection*, was added to Section 1.5 as one of the NFPA codes and standards deemed equivalent to the code for purposes of installation of fuel tanks for diesel-driven fire pumps.
- (3) Definitions for the various building occupancies were amended to correlate with the preferred definitions as found in NFPA 101<sup>®</sup>, *Life Safety Code*<sup>®</sup>.
- (4) The definitions of *fire-resistant tank* and *protected aboveground tank* were relocated to Chapter 22, Storage of Liquids in Tanks — Aboveground Storage Tanks.
- (5) New provisions were added to require that Class II and Class III liquids that are stored, handled, processed, or used at temperatures at or above their flash points follow all applicable requirements in the code for Class I liquids, unless an engineering evaluation deems otherwise. Supplementary information was included in Annex A. In addition, direct reference to this provision was added at appropriate locations in subsequent chapters.
- (6) An annex item was added to 6.5.1 to explain that use of spark-resistant tools must be evaluated on a case-by-case basis.
- (7) New Section 6.10 and the accompanying Annex G were added to address management of facility security by means of a mandatory security and vulnerability assessment. Annex G provides an outline of a suggested assessment process.
- (8) Annex guidance was added to 9.5.4.2 for selecting a safe location to which a flammable liquids storage cabinet can be vented.
- (9) The provisions for flammable liquids storage cabinets were amended to incorporate more extensive marking requirements.
- (10) A footnote was added to Table 9.9.1, Fire Resistance Ratings for Liquid Storage Areas, to indicate that no fire resistance rating is required for separation walls for accessory use areas of small floor area.



- (11) Section 13.3 was revised to more clearly establish the required separation between detached unprotected liquids storage buildings and both protected and unprotected exposed properties.
- (12) Numerous minor amendments were made to clarify application of the provisions of Chapter 16.
- (13) A new subsection, 17.3.7, was added to address process vessels used to heat liquids to temperatures at or above their flash points, as suggested by the U.S. Chemical Safety and Hazard Investigation Board.
- (14) An Annex A item was added to 18.6.3 to provide guidance for selecting a safe location to which a flammable liquids dispensing area can be vented.
- (15) Subsection 21.4.3, Normal Venting for Storage Tanks, was amended to clarify its application. An Annex A item was included to clarify that the interstitial space of a secondary containment tank does not require normal venting.
- (16) A new 21.5.2.1 was added to clarify that tightness testing is not required for an interstitial space of a secondary containment tank that maintains factory-applied vacuum.
- (17) A note and Annex A item were added to Table 22.4.2.1, Minimum Shell-to-Shell Spacing of Aboveground Storage Tanks, to explain the term *sum of adjacent diameters* and its determination.
- (18) Subsection 22.17.4 was amended to provide additional guidance on handling floating roof pontoons that have been breached by liquids or vapors.
- (19) Section 23.14 was amended so that it no longer allows the use of water ballast to secure underground tanks in areas subject to flooding.

The 2015 edition of NFPA 30 incorporates the following major amendments:

- (1) The definition of “safety can” has been amended to incorporate a screen/strainer in each fill and pour opening. This recognizes the actual construction of safety cans as currently manufactured and listed.
- (2) A 12-ft (3.6-m) storage height restriction has been imposed on unprotected storage in mercantile occupancies, to be consistent with the storage height restriction already in place for mercantile occupancies protected in accordance with NFPA 13, *Standard for the Installation of Sprinkler Systems*, for ordinary hazard Group 2.
- (3) Numerous amendments have been made to Chapter 16 to clarify intent, to eliminate certain inconsistencies between NFPA 30 and NFPA 13, and to correlate with terminology used in and specific requirements of NFPA 13.
- (4) Subsection 17.4.3 and Table 17.4.3 have been amended to increase the required separation distances between process vessels and adjacent important buildings, adjacent property lines, and the near and far sides of public ways. The amendments address recommendations submitted by the U.S. Chemical Safety and Hazard Investigation Board.
- (5) A new subsection, 18.4.4, has been added to address hand-operated pumps to dispense liquids that function using compressed air.
- (6) New Section 19.7 has been added to address the installation of cooking oil storage and dispensing systems for use in commercial kitchens, such as restaurants and prepared food production facilities.
- (7) Section 22.7 has been amended to eliminate the use of a weak roof-to-shell seam as an allowed means of emergency venting for ANSI/UL 142 steel aboveground storage tanks.
- (8) Subsection 22.11.4 has been amended to set a 50,000 gal maximum capacity for all secondary containment-type storage tanks for all Class I, Class II, and Class IIIA liquids.
- (9) Subsection 27.4.4 has been amended to strengthen the provisions regarding the use of low melting point piping materials. The amendments address recommendations submitted by the U.S. Chemical Safety and Hazard Investigation Board.
- (10) Section 28.11 has been amended by adding certain operating requirements for the person responsible for loading or unloading tank vehicles. These correlate with the provisions of NFPA 385, *Standard for Tank Vehicles for Flammable and Combustible Liquids*.
- (11) A new Annex A item, A.21.7.2.2, has been added to address security of storage tanks in remote unattended locations. This addresses recommendations submitted by the U.S. Chemical Safety and Hazard Investigation Board.

## Correlating Committee on Flammable and Combustible Liquids

**Jack Woycheese**, *Chair*  
Hughes Associates, Inc., CA [SE]

**Tracey D. Bellamy**, Telgian Corporation, GA [U]  
Rep. The Home Depot  
**Douglas W. Fisher**, Fisher Engineering, Inc., GA [SE]  
**John J. Foley**, The RJA Group, Inc., GA [SE]  
**Richard S. Kraus**, API/Petroleum Safety Consultants, VA [M]

Rep. American Petroleum Institute  
**William E. Rehr**, International Code Council, IL [E]  
**Roland A. Riegel**, UL LLC, NY [RT]  
**Douglas A. Rivers**, 3M Company, MN [U]  
**Peter J. Willse**, XL Global Asset Protection Services, CT [I]

### Alternates

**Luis F. Arango**, XL Global Asset Protection Services, TX [I]  
(Alt. to P. J. Willse)  
**John D. Campbell**, Telgian Corporation, MO [U]  
(Alt. to T. D. Bellamy)  
**Jonathan M. Eisenberg**, The RJA Group, Inc., MA [SE]  
(Alt. to J. J. Foley)

**Alfredo M. Ramirez**, UL LLC, IL [RT]  
(Alt. to R. A. Riegel)  
**Clark D. Shepard**, ExxonMobil Corporation, VA [M]  
(Alt. to R. S. Kraus)  
**Richard E. Stutzki**, 3M Company, MN [U]  
(Alt. to D. A. Rivers)

### Nonvoting

**David L. Blomquist**, Blomquist Fire Protection Engineering, CA  
(Member Emeritus)  
**Stephen W. Haines**, Haines Fire & Risk Consulting Corp., NJ [SE]  
Rep. TC on Tank Storage and Piping Systems  
**Dwight H. Havens**, Bechtel Marine Propulsion Corporation, NY [U]  
Rep. TC on Operations

**Donald M. Johnson**, Walnut Creek, CA  
(Member Emeritus)  
**John A. LeBlanc**, FM Global, MA [I]  
Rep. TC on Storage and Warehousing of Containers and Portable Tanks  
**Brooke B. Smith, Jr.**, Woodland Park, CO [SE]  
(Member Emeritus)  
**Christopher J. Wieczorek**, FM Global, MA [I]  
Rep. TC on Fundamentals

**Robert P. Benedetti**, NFPA Staff Liaison

*This list represents the membership at the time the Committee was balloted on the final text of this edition. Since that time, changes in the membership may have occurred. A key to classifications is found at the back of the document.*

NOTE: Membership on a committee shall not in and of itself constitute an endorsement of the Association or any document developed by the committee on which the member serves.

**Committee Scope:** This Committee shall have primary responsibility for documents on safeguarding against the fire and explosion hazards associated with the storage, handling, and use of flammable and combustible liquids; and classifying flammable and combustible liquids.

## Technical Committee on Fundamentals

**Christopher J. Wieczorek**, *Chair*  
FM Global, MA [I]

**Robert P. Benedetti**, *Administrative Secretary*  
National Fire Protection Association, MA

**Peter R. Apostoluk**, Greif Inc., OH [M]  
**Jonathan R. Barber**, RCP Inc., TX [SE]  
**John Slear Bond**, State of Alaska Department of Public Safety, AK [E]  
**Gregory C. Brennecke**, Liberty Northwest Insurance, WA [I]  
**Curtis W. Crumholt**, Takasago International Corporation, NJ [M]  
**Claire V. De Taeye**, Travelers Insurance Company, NY [I]  
**Carl M. Drechsel**, U.S. Department of the Air Force, VA [U]  
**Elson G. Fernandes**, Elfent Ltd., Canada [M]  
**John J. Foley**, The RJA Group, Inc., GA [SE]  
**Felix J. Garfunkel**, Parsons Corporation, MA [SE]

**Frederic Gil**, BP, United Kingdom [M]  
**Dwight H. Havens**, Bechtel Marine Propulsion Corporation, NY [U]  
**Gene L. Hertz**, The Dow Chemical Company, PA [M]  
**Jay J. Jablonski**, HSB PLC, CT [I]  
**John W. King**, Federated Mutual Insurance Company, MN [I]  
**Richard S. Kraus**, API/Petroleum Safety Consultants, VA [M]  
Rep. American Petroleum Institute  
**Tingguang Ma**, Oklahoma State University, OK [SE]  
**Bob D. Morgan**, Fort Worth Fire Department, TX [E]  
**David P. Nugent**, Valspar Corporation, IL [M]  
**Alfredo M. Ramirez**, UL LLC, IL [RT]



**John W. Richmond, Sr.**, Eastman Chemical Company, TN [M]  
**Michael L. Savage, Sr.**, Middle Department Inspection Agency, Inc., MD [E]  
**Peter M. Shank**, Nuclear Service Organization, DE [I]

**Warren G. Stocker**, Safeway Inc., CA [U]  
**Robert Upson**, Southington Fire Department, CT [E]  
**Paul Wagner**, Leber/Rubes Inc. (LRI), Canada [SE]  
**Kevin J. Wolf**, Intertek Testing Services, NY [RT]  
**Jack Woycheese**, Hughes Associates, Inc., CA [SE]

#### Alternates

**Laura (Bradbury) Green**, BP Exploration, UK [M]  
 (Alt. to F. Gil)  
**Melinda Elaine Hurd**, Leber/Rubes Inc., Canada [SE]  
 (Alt. to P. Wagner)  
**Thomas Izbicki**, The RJA Group, Inc., TX [SE]  
 (Alt. to J. J. Foley)  
**John A. LeBlanc**, FM Global, MA [I]  
 (Alt. to C. J. Wiczorek)  
**Roland A. Riegel**, UL LLC, NY [RT]  
 (Alt. to A. M. Ramirez)

**Joseph L. Scheffey**, Hughes Associates, Inc., MD [SE]  
 (Alt. to J. Woycheese)  
**Clark D. Shepard**, ExxonMobil Corporation, VA [M]  
 (Alt. to R. S. Kraus)  
**David Upchurch**, HSB PLC, GA [I]  
 (Alt. to J. J. Jablonski)  
**Robert P. Wethington**, Dow Corning Corporation, KY [M]  
 (Alt. to G. L. Hortz)

#### Nonvoting

**Jeffrey J. Wanko**, U.S. Department of Labor, DC [E]

**Robert P. Benedetti**, NFPA Staff Liaison

*This list represents the membership at the time the Committee was balloted on the final text of this edition. Since that time, changes in the membership may have occurred. A key to classifications is found at the back of the document.*

NOTE: Membership on a committee shall not in and of itself constitute an endorsement of the Association or any document developed by the committee on which the member serves.

**Committee Scope:** This Committee shall have primary responsibility for documents or portions of documents on the basic requirements for safeguarding against the fire and explosion hazards associated with the storage and handling of flammable and combustible liquids. This Committee shall also have responsibility for definitions related to flammable and combustible liquids and for criteria for the classification of flammable and combustible liquids.

## Technical Committee on Operations

**Dwight H. Havens**, *Chair*

Bechtel Marine Propulsion Corporation, NY [U]

**Gregory P. Bareta**, Wisconsin Department of Commerce, WI [E]  
**Claire V. De Taeye**, Travelers Insurance Company, NY [I]  
**Jonathan M. Eisenberg**, The RJA Group, Inc., MA [SE]  
**Harold E. Grossman II**, Alcoa, Inc., IN [U]  
**Richard J. Hild**, Axalta Coating Systems, MD [M]  
**Jay J. Jablonski**, HSB PLC, CT [I]  
**David C. Kirby**, Baker Engineering & Risk Consultants, Inc., WV [SE]  
**Gregory D. Kirby**, CYTEC Industries, Inc., WV [M]  
**Richard S. Kraus**, API/Petroleum Safety Consultants, VA [M]  
 Rep. American Petroleum Institute  
**John A. LeBlanc**, FM Global, MA [I]  
**Jonathan P. Levin**, Liberty Mutual Commercial Markets, MA [I]  
 Rep. Property Casualty Insurers Association of America  
**Gregory A. Milewski**, Shell Oil, TX [M]  
**Anthony M. Ordile**, Haines Fire & Risk Consulting Corporation, NJ [SE]

**Alfredo M. Ramirez**, UL LLC, IL [RT]  
**Robert N. Renkes**, Petroleum Equipment Institute, OK [M]  
**John W. Richmond, Sr.**, Eastman Chemical Company, TN [M]  
**Douglas A. Rivers**, 3M Company, MN [U]  
**Ronald G. Schaffhauser**, PPG Industries, Inc., PA [M]  
**George A. Seuss, Jr.**, The Hanover Insurance Group, MD [I]  
**Clark D. Shepard**, ExxonMobil Corporation, VA [M]  
**Michael D. Snyder**, Dow Corning Corporation, MI [U]  
 Rep. NFPA Industrial Fire Protection Section  
**Beth Tate**, Office of the Fire Marshal, Canada [E]  
**Scott M. Tyler**, AREVA NP, Inc., IL [U]  
 Rep. Edison Electric Institute  
**David B. Wechsler**, Katy, TX [U]  
 Rep. American Chemistry Council  
**Peter J. Willse**, XL Global Asset Protection Services, CT [I]  
**Jack Woycheese**, Hughes Associates, Inc., CA [SE]

#### Alternates

**Tim D. Blackford**, Chevron Energy Technology Company, TX [M]  
 (Alt. to R. S. Kraus)

**Mark Driscoll**, XL Global Asset Protection Services, MA [I]  
 (Alt. to P. J. Willse)  
**John J. Foley**, The RJA Group, Inc., GA [SE]  
 (Alt. to J. M. Eisenberg)



**David R. Hague**, Liberty Mutual Insurance, MA [I]  
(Alt. to J. P. Levin)  
**Stephen W. Haines**, Haines Fire & Risk Consulting Corp., NJ [SE]  
(Alt. to A. M. Ordile)  
**Donald B. Hicks**, Dow Corning Corporation, MI [U]  
(Alt. to M. D. Snyder)  
**David W. Owen**, ExxonMobil Corporation, TX [M]  
(Alt. to C. D. Shepard)  
**Duane L. Rehmeier**, Baker Engineering & Risk Consultants, Inc., PA [SE]  
(Alt. to D. C. Kirby)

**Roland A. Riegel**, UL LLC, NY [RT]  
(Alt. to A. M. Ramirez)  
**Joseph L. Scheffey**, Hughes Associates, Inc., MD [SE]  
(Alt. to J. Woychese)  
**Richard E. Stutzki**, 3M Company, MN [U]  
(Alt. to D. A. Rivers)  
**David Upchurch**, HSB PLC, GA [I]  
(Alt. to J. J. Jablonski)  
**Christopher J. Wieczorek**, FM Global, MA [I]  
(Alt. to J. A. LeBlanc)

#### Nonvoting

**Matthew I. Chibbaro**, U.S. Department of Labor, DC [E]

**William R. Hamilton**, U.S. Department of Labor, DC [E]

**Robert P. Benedetti**, NFPA Staff Liaison

*This list represents the membership at the time the Committee was balloted on the final text of this edition. Since that time, changes in the membership may have occurred. A key to classifications is found at the back of the document.*

NOTE: Membership on a committee shall not in and of itself constitute an endorsement of the Association or any document developed by the committee on which the member serves.

**Committee Scope:** This Committee shall have primary responsibility for documents or portions of documents on safeguarding against the fire and explosion hazards associated with operations that involve the handling, transfer, and use of flammable and combustible liquids, either as a principal activity or as an incidental activity.

### Technical Committee on Storage and Warehousing of Containers and Portable Tanks

**John A. LeBlanc**, *Chair*  
FM Global, MA [I]

**Peter R. Apostoluk**, Greif Inc., OH [M]  
**Tracey D. Bellamy**, Telgian Corporation, GA [U]  
Rep. The Home Depot  
**Glen A. Carter**, Justrite Manufacturing Company, LLC, IL [M]  
**Claire V. De Taeye**, Travelers Insurance Company, NY [I]  
**John J. Foley**, The RJA Group, Inc., GA [SE]  
**Edward S. Goldhammer**, Aon Fire Protection, CA [I]  
**Dwight H. Havens**, Bechtel Marine Propulsion Corporation, NY [U]  
**Donald B. Hicks**, Dow Corning Corporation, MI [U]  
Rep. NFPA Industrial Fire Protection Section  
**Richard J. Hild**, Axalta Coating Systems, MD [M]  
Rep. American Coatings Association  
**David C. Kirby**, Baker Engineering & Risk Consultants, Inc., WV [SE]  
**Richard S. Kraus**, API/Petroleum Safety Consultants, VA [M]  
Rep. American Petroleum Institute  
**Jonathan P. Levin**, Liberty Mutual Commercial Markets, MA [I]

Rep. Property Casualty Insurers Association of America  
**John A. McQuaid**, IPANA/SSCI, VA [M]  
**Navin D. Mehta**, U.S. Department of Defense, VA [U]  
**David P. Nugent**, Valspar Corporation, IL [M]  
**Anthony M. Ordile**, Haines Fire & Risk Consulting Corporation, NJ [SE]  
**Roland A. Riegel**, UL LLC, NY [RT]  
**Lee T. Rindfuss**, Marsh Risk Consulting, MA [I]  
**Douglas A. Rivers**, 3M Company, MN [U]  
**Joseph L. Scheffey**, Hughes Associates, Inc., MD [SE]  
**George A. Seuss, Jr.**, The Hanover Insurance Group, MD [I]  
**Michael Spence**, Brown Sprinkler Corporation, KY [M]  
Rep. National Fire Sprinkler Association  
**David C. Tabar**, The Sherwin-Williams Company, OH [M]  
**Beth Tate**, Office of the Fire Marshal, Canada [E]  
**Peter J. Willse**, XL Global Asset Protection Services, CT [I]  
**Martin H. Workman**, The Viking Corporation, MI [IM]  
Rep. American Fire Sprinkler Association

#### Alternates

**John D. Campbell**, Telgian Corporation, MO [U]  
(Alt. to T. D. Bellamy)  
**Jonathan M. Eisenberg**, The RJA Group, Inc. [SE]  
(Alt. to J. J. Foley)  
**Stephen W. Haines**, Haines Fire & Risk Consulting Corp., NJ [SE]  
(Alt. to A. M. Ordile)  
**Todd M. Kidd**, Liberty Mutual Insurance Companies, NC [I]  
(Alt. to J. P. Levin)

**Thomas S. Lentz**, Aon Risk Services, Inc., IL [I]  
(Alt. to E. S. Goldhammer)  
**Gregory A. Milewski**, Shell Oil, TX [M]  
(Alt. to R. S. Kraus)  
**Benjamin L. Nelson**, Dow Corning Corporation/Hemlock Semiconductor, MI [U]  
(Alt. to D. B. Hicks)  
**Alfredo M. Ramirez**, UL LLC, IL [RT]  
(Alt. to R. A. Riegel)



**Duane L. Rehmeier**, Baker Engineering & Risk Consultants, Inc., PA [SE]  
(Alt. to D. C. Kirby)  
**Ronald J. Stephens**, Allan Automatic Sprinkler Corp. of So. California, CA [M]  
(Alt. to M. Spence)  
**Arthur M. Stevens**, Stevens Associates, FL [M]  
(Alt. to G. A. Carter)  
**Richard E. Stutzki**, 3M Company, MN [U]  
(Alt. to D. A. Rivers)

**David C. Swenson**, The Sherwin-Williams Company, OH [M]  
(Alt. to D. C. Tabar)  
**Christopher J. Wieczorek**, FM Global, MA [I]  
(Alt. to J. A. LeBlanc)  
**Jack Woycheese**, Hughes Associates, Inc., CA [SE]  
(Alt. to J. L. Scheffey)

**Robert P. Benedetti**, NFPA Staff Liaison

*This list represents the membership at the time the Committee was balloted on the final text of this edition. Since that time, changes in the membership may have occurred. A key to classifications is found at the back of the document.*

NOTE: Membership on a committee shall not in and of itself constitute an endorsement of the Association or any document developed by the committee on which the member serves.

**Committee Scope:** This Committee shall have primary responsibility for documents or portions of documents on safeguarding against the fire and explosion hazards associated with the storage, warehousing, and display merchandising of flammable and combustible liquids in containers and in portable tanks whose capacity does not exceed 2500 liters (660 gallons).

## Technical Committee on Tank Storage and Piping Systems

**Stephen W. Haines**, *Chair*

Haines Fire & Risk Consulting Corp., NJ [SE]

**Steven P. Allwein**, Morrison Brothers Company, IA [M]  
**John H. Bagnall**, Burns & McDonnell Engineering Company, MO [SE]  
**Gregory P. Bareta**, Wisconsin Department of Commerce, WI [E]  
**Tim D. Blackford**, Chevron Energy Technology Company, TX [U]  
Rep. American Petroleum Institute  
**John V. Cignatta**, Datanet Engineering, Inc., MD [SE]  
**Sullivan D. Curran**, Fiberglass Tank & Pipe Institute, TX [M]  
**Charles A. Davis**, URS Corporation, FL [SE]  
**Claire V. De Taeey**, Travelers Insurance Company, NY [I]  
**Michael Doxey**, HMT Inc., TX [M]  
**Wayne B. Geyer**, Steel Tank Institute (STI/SPFA), IL [M]  
**Edward S. Goldhammer**, Aon Fire Protection, CA [I]  
**Dwight H. Havens**, Bechtel Marine Propulsion Corporation, NY [U]  
**David C. Kirby**, Baker Engineering & Risk Consultants, Inc., WV [SE]

**Gregory D. Kirby**, CYTEC Industries, Inc., WV [U]  
**David P. Nugent**, Valspar Corporation, IL [U]  
**Marcia Jo Poxson**, Michigan Department of Environmental Quality, MI [E]  
**Niall Ramsden**, Resource Protection International, United Kingdom [SE]  
**Robert N. Renkes**, Petroleum Equipment Institute, OK [M]  
**John W. Richmond, Sr.**, Eastman Chemical Company, TN [U]  
**Roland A. Riegel**, UL LLC, NY [RT]  
**James R. Rocco**, Sage Risk Solutions, LLC, OH [U]  
Rep. Petroleum Marketers Association of America  
**Tim G. Schroeder**, Husky Corporation, MO [M]  
**Clark D. Shepard**, ExxonMobil Corporation, VA [U]  
**Beth Tate**, Office of the Fire Marshal, Canada [E]  
**David B. Wechsler**, Katy, TX [U]  
Rep. American Chemistry Council  
**Peter J. Willse**, XL Global Asset Protection Services, CT [I]  
**Jack Woycheese**, Hughes Associates, Inc., CA [SE]

### Alternates

**Luis F. Arango**, XL Global Asset Protection Services, TX [I]  
(Alt. to P. J. Willse)  
**Richard S. Kraus**, API/Petroleum Safety Consultants, VA [U]  
(Alt. to T. D. Blackford)  
**Thomas S. Lentz**, Aon Risk Services, Inc., IL [I]  
(Alt. to E. S. Goldhammer)  
**Patrick A. McLaughlin**, McLaughlin & Associates, ID [M]  
(Alt. to S. D. Curran)  
**Anthony M. Ordile**, Haines Fire & Risk Consulting Corporation, NJ [SE]  
(Alt. to S. W. Haines)  
**David W. Owen**, ExxonMobil Corporation, TX [U]  
(Alt. to C. D. Shepard)

**Charles R. Plummer**, PPM Consultants, Inc., LA [U]  
(Alt. to J. R. Rocco)  
**Alfredo M. Ramirez**, UL LLC, IL [RT]  
(Alt. to R. A. Riegel)  
**Duane L. Rehmeier**, Baker Engineering & Risk Consultants, Inc., PA [SE]  
(Alt. to D. C. Kirby)  
**Joseph L. Scheffey**, Hughes Associates, Inc., MD [SE]  
(Alt. to J. Woycheese)  
**Jeffrey M. Shapiro**, International Code Consultants, TX [M]  
(Alt. to W. B. Geyer)  
**R. Jeff Tanner**, Michigan Department of Environmental Quality, MI [E]  
(Alt. to M. J. Poxson)

**Nonvoting**

**David L. Blomquist**, Blomquist Fire Protection  
Engineering, CA  
(Member Emeritus)  
**Donald M. Johnson**, Walnut Creek, CA  
(Member Emeritus)

**Orville M. Slye, Jr.**, Loss Control Associates, Inc., PA  
(Member Emeritus)  
**Brooke B. Smith, Jr.**, Woodland Park, CO [SE]  
(Member Emeritus)  
**Jeffrey J. Wanko**, U.S. Department of Labor, DC [E]

**Robert P. Benedetti**, NFPA Staff Liaison

*This list represents the membership at the time the Committee was balloted on the final text of this edition. Since that time, changes in the membership may have occurred. A key to classifications is found at the back of the document.*

NOTE: Membership on a committee shall not in and of itself constitute an endorsement of the Association or any document developed by the committee on which the member serves.

**Committee Scope:** This Committee shall have primary responsibility for documents or portions of documents on safeguarding against the fire and explosion hazards associated with the storage of flammable and combustible liquids in fixed aboveground and underground tanks of any size, including tanks in buildings, except as specifically covered by other NFPA documents, and with the installation of piping systems for flammable and combustible liquids. This Committee shall also have primary responsibility for documents or portions of documents on safeguarding against the fire and explosion hazards associated with the storage of flammable and combustible liquids in portable tanks whose capacity exceeds 2500 liters (660 gallons).

Contents

<b>Chapter 1 Administration</b> .....	<b>30- 14</b>	7.2	Definitions Specific to Chapter 7. (Reserved) .....	<b>30- 24</b>
1.1 Scope .....	30- 14	7.3	General Requirements .....	30- 24
1.2 Purpose .....	30- 14	7.4	Application of Area Classification .....	30- 27
1.3 Application .....	30- 14			
1.4 Retroactivity .....	30- 14			
1.5 Equivalency .....	30- 15			
1.6 Symbols, Units, and Formulas .....	30- 15			
1.7 Code Adoption Requirements. (Reserved) .....	30- 15	<b>Chapter 8 Reserved</b> .....		<b>30- 27</b>
1.8 Permits. (Reserved) .....	30- 15	<b>Chapter 9 Storage of Liquids in Containers —</b>		
1.9 Enforcement .....	30- 15	<b>General Requirements</b> .....		<b>30- 27</b>
		9.1 Scope .....		30- 27
<b>Chapter 2 Referenced Publications</b> .....	<b>30- 15</b>	9.2 Definitions Specific to Chapter 9. (Reserved) .....		30- 27
2.1 General .....	30- 15	9.3 General Requirements .....		30- 27
2.2 NFPA Publications .....	30- 16	9.4 Acceptable Containers .....		30- 28
2.3 Other Publications .....	30- 16	9.5 Flammable Liquids Storage Cabinets .....		30- 29
2.4 References for Extracts in Mandatory Sections .....	30- 17	9.6 Maximum Allowable Quantities (MAQs) per Control Area .....		30- 30
		9.7 Control Areas .....		30- 31
<b>Chapter 3 Definitions</b> .....	<b>30- 17</b>	9.8 Classification of Occupancies That Exceed the Maximum Allowable Quantities of Liquids per Control Area .....		30- 31
3.1 General .....	30- 17	9.9 Construction Requirements .....		30- 31
3.2 NFPA Official Definitions .....	30- 17	9.10 Fire Protection .....		30- 32
3.3 General Definitions .....	30- 18	9.11 Emergency Control Systems. (Reserved) .....		30- 32
<b>Chapter 4 Definition and Classification of Liquids</b> .....	<b>30- 21</b>	9.12 Electrical Systems .....		30- 32
4.1 Scope .....	30- 21	9.13 Containment, Drainage, and Spill Control .....		30- 32
4.2 Definitions Specific to Chapter 4 .....	30- 21	9.14 Ventilation .....		30- 32
4.3 Classification of Liquids .....	30- 21	9.15 Exhausted Enclosures. (Reserved) .....		30- 33
4.4 Determination of Flash Point .....	30- 21	9.16 Explosion Control .....		30- 33
4.5 Relationship to Other Classification Systems. (Reserved) .....	30- 22	9.17 Separation from Incompatible Materials .....		30- 33
<b>Chapter 5 Reserved</b> .....	<b>30- 22</b>	9.18 Dispensing, Handling, and Use of Liquids in Storage Areas .....		30- 33
<b>Chapter 6 Fire and Explosion Prevention and Risk Control</b> .....	<b>30- 22</b>	9.19 Outdoor Storage of Liquids .....		30- 33
6.1 Scope .....	30- 22	<b>Chapter 10 Storage of Liquids in Containers —</b>		
6.2 Definitions Specific to Chapter 6 .....	30- 22	<b>Mercantile Occupancies</b> .....		<b>30- 33</b>
6.3 Management of Fire and Explosion Hazards .....	30- 22	10.1 Scope .....		30- 33
6.4 Hazards Analysis .....	30- 22	10.2 Definitions Specific to Chapter 10. (Reserved) .....		30- 33
6.5 Control of Ignition Sources .....	30- 22	10.3 General Requirements .....		30- 33
6.6 Detection and Alarm Systems and Procedures .....	30- 23	10.4 Reserved .....		30- 33
6.7 Fire Protection and Fire Suppression Systems .....	30- 23	10.5 Reserved .....		30- 33
6.8 Emergency Planning and Training .....	30- 23	10.6 Reserved .....		30- 33
6.9 Inspection and Maintenance .....	30- 24	10.7 Control Areas .....		30- 33
6.10 Management of Security .....	30- 24	10.8 Specific Restrictions .....		30- 34
<b>Chapter 7 Electrical Systems</b> .....	<b>30- 24</b>	10.9 Construction Requirements .....		30- 34
7.1 Scope .....	30- 24	10.10 Fire Protection .....		30- 34
		10.11 Emergency Control Systems. (Reserved) .....		30- 34
		10.12 Electrical Systems .....		30- 35

10.13	Containment, Drainage, and Spill Control .....	30- 35	13.6	Maximum Allowable Quantities and Maximum Storage Heights .....	30- 38
10.14	Ventilation .....	30- 35	13.7	Control Areas. (Reserved) .....	30- 38
10.15	Exhausted Enclosures. (Reserved) .....	30- 35	13.8	Reserved .....	30- 38
10.16	Explosion Control. (Reserved) .....	30- 35	13.9	Construction Requirements .....	30- 38
10.17	Separation from Incompatible Materials .....	30- 35	13.10	Fire Protection .....	30- 38
10.18	Dispensing, Handling, and Use of Liquids in Mercantile Occupancies .....	30- 35	13.11	Emergency Control Systems. (Reserved) .....	30- 38
10.19	Outdoor Storage of Liquids .....	30- 35	13.12	Electrical Systems .....	30- 38
<b>Chapter 11 Storage of Liquids in Containers — Industrial Occupancies .....</b>			13.13	Containment, Drainage, and Spill Control .....	30- 38
11.1	Scope .....	30- 35	13.14	Ventilation .....	30- 38
11.2	Definitions Specific to Chapter 11. (Reserved) .....	30- 35	13.15	Exhausted Enclosure. (Reserved) .....	30- 38
11.3	General Requirements .....	30- 35	13.16	Explosion Control .....	30- 38
<b>Chapter 12 Storage of Liquids in Containers — Storage Occupancies .....</b>			13.17	Separation from Incompatible Materials .....	30- 38
12.1	Scope .....	30- 35	13.18	Dispensing, Handling, and Use of Liquids in Detached, Unprotected Buildings .....	30- 38
12.2	Definitions Specific to Chapter 12. (Reserved) .....	30- 35	13.19	Outdoor Storage of Liquids .....	30- 38
12.3	General Requirements .....	30- 35	<b>Chapter 14 Hazardous Materials Storage Lockers .....</b>		
12.4	Reserved .....	30- 36	14.1	Scope .....	30- 38
12.5	Reserved .....	30- 36	14.2	Definitions Specific to Chapter 14. (Reserved) .....	30- 38
12.6	Maximum Allowable Quantities and Maximum Storage Heights .....	30- 36	14.3	General Requirements .....	30- 39
12.7	Control Areas .....	30- 36	14.4	Design and Construction of Hazardous Materials Storage Lockers .....	30- 39
12.8	General-Purpose Warehouses .....	30- 36	14.5	Designated Sites for Hazardous Materials Storage Lockers .....	30- 39
12.9	Construction Requirements .....	30- 37	14.6	Storage Requirements .....	30- 39
12.10	Fire Protection .....	30- 37	<b>Chapter 15 Outdoor Storage .....</b>		
12.11	Emergency Control Systems. (Reserved) .....	30- 37	15.1	Scope .....	30- 39
12.12	Electrical Systems .....	30- 37	15.2	Definitions Specific to Chapter 15. (Reserved) .....	30- 40
12.13	Containment, Drainage, and Spill Control .....	30- 37	15.3	General Requirements .....	30- 40
12.14	Ventilation .....	30- 37	15.4	Outdoor Storage Adjacent to a Building .....	30- 40
12.15	Exhausted Enclosures. (Reserved) .....	30- 37	<b>Chapter 16 Automatic Fire Protection for Inside Liquid Storage Areas .....</b>		
12.16	Explosion Control .....	30- 37	16.1	Scope .....	30- 41
12.17	Separation from Incompatible Materials .....	30- 37	16.2	Definitions Specific to Chapter 16 .....	30- 41
12.18	Dispensing, Handling, and Use of Liquids in Storage Occupancies .....	30- 37	16.3	General Requirements .....	30- 41
12.19	Outdoor Storage of Liquids .....	30- 37	16.4	Automatic Sprinkler and Foam-Water Sprinkler Fire Protection Systems .....	30- 42
<b>Chapter 13 Storage of Liquids in Containers — Detached, Unprotected Buildings .....</b>			16.5	Fire Protection System Design Criteria ..	30- 42
13.1	Scope .....	30- 37	16.6	Fire Protection System Design Schemes .....	30- 55
13.2	Definitions Specific to Chapter 13. (Reserved) .....	30- 37	16.7	Water Supply .....	30- 59
13.3	General Requirements .....	30- 37	16.8	Containment, Drainage, and Spill Control .....	30- 59
13.4	Reserved .....	30- 38	16.9	Other Automatic Fire Protection Systems .....	30- 62
13.5	Reserved .....	30- 38			



<b>Chapter 17 Processing Facilities</b> .....	<b>30- 62</b>	21.8	Inspection and Maintenance of Storage Tanks and Storage Tank Appurtenances .....	<b>30- 76</b>
17.1 Scope .....	<b>30- 62</b>	21.9	Change of Stored Liquid .....	<b>30- 76</b>
17.2 Definitions Specific to Chapter 17. (Reserved) .....	<b>30- 62</b>	<b>Chapter 22 Storage of Liquids in Tanks — Aboveground Storage Tanks</b> .....	<b>30- 76</b>	
17.3 General Requirements .....	<b>30- 62</b>	22.1	Scope .....	<b>30- 76</b>
17.4 Location of Process Vessels and Equipment .....	<b>30- 62</b>	22.2	Definitions Specific to Chapter 22 .....	<b>30- 76</b>
17.5 Accessibility .....	<b>30- 62</b>	22.3	General Requirements .....	<b>30- 77</b>
17.6 Construction Requirements .....	<b>30- 63</b>	22.4	Location of Aboveground Storage Tanks .....	<b>30- 77</b>
17.7 Fire Protection. (Reserved) .....	<b>30- 64</b>	22.5	Installation of Aboveground Storage Tanks .....	<b>30- 80</b>
17.8 Emergency Control Systems. (Reserved) .....	<b>30- 64</b>	22.6	Vent Piping for Aboveground Tanks .....	<b>30- 81</b>
17.9 Electrical Systems .....	<b>30- 64</b>	22.7	Emergency Relief Venting for Fire Exposure for Aboveground Storage Tanks .....	<b>30- 81</b>
17.10 Containment, Drainage, and Spill Control .....	<b>30- 64</b>	22.8	Fire Protection for Aboveground Storage Tanks .....	<b>30- 83</b>
17.11 Ventilation .....	<b>30- 64</b>	22.9	Additional Requirements for Fire-Resistant Aboveground Storage Tanks .....	<b>30- 83</b>
17.12 Explosion Control. (Reserved) .....	<b>30- 64</b>	22.10	Additional Requirements for Protected Aboveground Storage Tanks .....	<b>30- 83</b>
17.13 Process Structures. (Reserved) .....	<b>30- 64</b>	22.11	Control of Spills from Aboveground Storage Tanks .....	<b>30- 83</b>
17.14 Process Equipment and Vessels .....	<b>30- 64</b>	22.12	Equipment, Piping, and Fire Protection Systems in Remote Impoundment Areas and Diked Areas .....	<b>30- 85</b>
17.15 Management of Operations Hazards .....	<b>30- 64</b>	22.13	Tank Openings Other Than Vents .....	<b>30- 86</b>
<b>Chapter 18 Dispensing, Handling, Transfer, and Use of Liquids</b> .....	<b>30- 65</b>	22.14	Aboveground Storage Tanks Located in Areas Subject to Flooding .....	<b>30- 86</b>
18.1 Scope .....	<b>30- 65</b>	22.15	Collision Protection for Aboveground Storage Tanks .....	<b>30- 86</b>
18.2 Definitions Specific to Chapter 18. (Reserved) .....	<b>30- 65</b>	22.16	Installation Instructions for Aboveground Storage Tanks .....	<b>30- 86</b>
18.3 General Requirements .....	<b>30- 65</b>	22.17	Inspection and Maintenance of Aboveground Storage Tanks .....	<b>30- 86</b>
18.4 Dispensing, Handling, Transfer, and Use .....	<b>30- 65</b>	<b>Chapter 23 Storage of Liquids in Tanks — Underground Tanks</b> .....	<b>30- 86</b>	
18.5 Incidental Operations .....	<b>30- 66</b>	23.1	Scope .....	<b>30- 86</b>
18.6 Ventilation for Dispensing Areas .....	<b>30- 66</b>	23.2	Definitions Specific to Chapter 23. (Reserved) .....	<b>30- 86</b>
<b>Chapter 19 Specific Operations</b> .....	<b>30- 67</b>	23.3	General Requirements .....	<b>30- 86</b>
19.1 Scope .....	<b>30- 67</b>	23.4	Location of Underground Storage Tanks .....	<b>30- 87</b>
19.2 Definitions Specific to Chapter 19 .....	<b>30- 67</b>	23.5	Installation of Underground Storage Tanks .....	<b>30- 87</b>
19.3 General Requirements. (Reserved) .....	<b>30- 67</b>	23.6	Normal Venting for Underground Storage Tanks .....	<b>30- 87</b>
19.4 Recirculating Heat Transfer Systems .....	<b>30- 67</b>	23.7	Reserved .....	<b>30- 87</b>
19.5 Vapor Recovery and Vapor Processing Systems .....	<b>30- 68</b>	23.8	Reserved .....	<b>30- 87</b>
19.6 Solvent Distillation Units .....	<b>30- 68</b>			
19.7 Cooking Oil Storage Tank Systems in Commercial Kitchens .....	<b>30- 69</b>			
<b>Chapter 20 Reserved</b> .....	<b>30- 70</b>			
<b>Chapter 21 Storage of Liquids in Tanks — Requirements for All Storage Tanks</b> .....	<b>30- 70</b>			
21.1 Scope .....	<b>30- 70</b>			
21.2 Definitions Specific to Chapter 21 .....	<b>30- 70</b>			
21.3 General Requirements .....	<b>30- 70</b>			
21.4 Design and Construction of Storage Tanks .....	<b>30- 71</b>			
21.5 Testing Requirements for Tanks .....	<b>30- 72</b>			
21.6 Fire Prevention and Control .....	<b>30- 73</b>			
21.7 Operation of Storage Tanks .....	<b>30- 74</b>			

23.9	Reserved .....	30- 87	25.8	Electrical Systems for Storage Tank Vaults .....	30- 92
23.10	Reserved .....	30- 87	25.9	Containment, Drainage, and Spill Control for Storage Tank Vaults .....	30- 92
23.11	Control of Spills from Underground Storage Tanks. (Reserved) .....	30- 87	25.10	Ventilation Systems for Storage Tank Vaults .....	30- 92
23.12	Reserved .....	30- 87	25.11	Reserved .....	30- 93
23.13	Tank Openings Other than Vents .....	30- 87	25.12	Explosion Control. (Reserved) .....	30- 93
23.14	Underground Storage Tanks Located in Areas Subject to Flooding .....	30- 88	25.13	Vents for Tanks Inside Storage Tank Vaults .....	30- 93
23.15	Reserved .....	30- 88	25.14	Tank Openings Other than Vents for Tanks Inside Storage Tank Vaults. (Reserved) .....	30- 93
23.16	Installation Instructions for Underground Storage Tanks .....	30- 88	25.15	Detection and Alarm Systems for Storage Tank Vaults .....	30- 93
23.17	Inspection and Maintenance of Underground Storage Tanks .....	30- 88	25.16	Inspection and Maintenance of Storage Tank Vaults and Equipment .....	30- 93
<b>Chapter 24</b>	<b>Storage Tank Buildings .....</b>	<b>30- 88</b>	<b>Chapter 26</b>	<b>Reserved .....</b>	<b>30- 93</b>
24.1	Scope .....	30- 88	<b>Chapter 27</b>	<b>Piping Systems .....</b>	<b>30- 93</b>
24.2	Definitions Specific to Chapter 24. (Reserved) .....	30- 88	27.1	Scope .....	30- 93
24.3	General Requirements. (Reserved) .....	30- 88	27.2	Definitions Specific to Chapter 27 .....	30- 93
24.4	Location of Storage Tank Buildings .....	30- 88	27.3	General Requirements .....	30- 93
24.5	Construction of Storage Tank Buildings .....	30- 89	27.4	Materials of Construction for Piping Systems .....	30- 93
24.6	Fire Protection for Storage Tank Buildings .....	30- 89	27.5	Pipe Joints .....	30- 94
24.7	Emergency Control Systems for Storage Tank Buildings. (Reserved) .....	30- 90	27.6	Installation of Piping Systems .....	30- 94
24.8	Electrical Systems for Storage Tank Buildings .....	30- 90	27.7	Testing of Piping Systems .....	30- 95
24.9	Containment, Drainage, and Spill Control from Storage Tank Buildings .....	30- 90	27.8	Vent Piping .....	30- 95
24.10	Ventilation for Storage Tank Buildings ...	30- 90	27.9	Bonding and Grounding .....	30- 96
24.11	Reserved .....	30- 91	27.10	Identification and Marking of Piping Systems .....	30- 96
24.12	Explosion Control. (Reserved) .....	30- 91	27.11	Special Requirements for Marine Piping Systems .....	30- 96
24.13	Vents for Tanks Inside Storage Tank Buildings .....	30- 91	27.12	Removal from Service of Piping Systems .....	30- 96
24.14	Tank Openings Other than Vents for Tanks Inside Storage Tank Buildings .....	30- 91	<b>Chapter 28</b>	<b>Bulk Loading and Unloading Facilities for Tank Cars and Tank Vehicles .....</b>	<b>30- 96</b>
24.15	Detection and Alarm Systems for Storage Tank Buildings .....	30- 91	28.1	Scope .....	30- 96
24.16	Inspection and Maintenance for Storage Tank Buildings .....	30- 91	28.2	Definitions Specific to Chapter 28. (Reserved) .....	30- 96
<b>Chapter 25</b>	<b>Storage Tank Vaults .....</b>	<b>30- 92</b>	28.3	General Requirements .....	30- 96
25.1	Scope .....	30- 92	28.4	Location of Loading and Unloading Facilities .....	30- 97
25.2	Definitions Specific to Chapter 25. (Reserved) .....	30- 92	28.5	Roofed Structures .....	30- 97
25.3	General Requirements .....	30- 92	28.6	Fire Protection. (Reserved) .....	30- 97
25.4	Location of Storage Tank Vaults .....	30- 92	28.7	Emergency Control Systems. (Reserved) .....	30- 97
25.5	Construction and Installation of Storage Tank Vaults .....	30- 92	28.8	Electrical Systems .....	30- 97
25.6	Fire Protection for Storage Tank Vaults .....	30- 92			
25.7	Emergency Controls for Storage Tank Vaults. (Reserved) .....	30- 92			



28.9	Containment, Drainage, and Spill Control .....	30- 97	<b>Annex D</b>	<b>Development of Fire Protection System Design Criteria for Chapter 16 and Suggested Fire Protection for Some Containers of Flammable and Combustible Liquids Not Covered in Chapter 16 .....</b>	<b>30-125</b>
28.10	Equipment .....	30- 97	<b>Annex E</b>	<b>Suggested Test Protocol for Developing Fire Protection System Design Criteria for Containers of Flammable and Combustible Liquids .....</b>	<b>30-131</b>
28.11	Operating Requirements .....	30- 97	<b>Annex F</b>	<b>Fugitive Emissions Calculations .....</b>	<b>30-135</b>
<b>Chapter 29</b>	<b>Wharves .....</b>	<b>30- 98</b>	<b>Annex G</b>	<b>Management of Security .....</b>	<b>30-137</b>
29.1	Scope .....	30- 98	<b>Annex H</b>	<b>Sample Ordinance Adopting NFPA 30 ...</b>	<b>30-139</b>
29.2	Definitions Specific to Chapter 29. (Reserved) .....	30- 98	<b>Annex I</b>	<b>Informational References .....</b>	<b>30-139</b>
29.3	General Requirements .....	30- 98	<b>Index</b>	<b>.....</b>	<b>30-144</b>
<b>Annex A</b>	<b>Explanatory Material .....</b>	<b>30-100</b>			
<b>Annex B</b>	<b>Emergency Relief Venting for Fire Exposure for Aboveground Tanks .....</b>	<b>30-119</b>			
<b>Annex C</b>	<b>Temporarily Out of Service, Closure in Place, or Closure by Removal of Underground Storage Tanks .....</b>	<b>30-123</b>			



## NFPA 30

## Flammable and Combustible Liquids Code

## 2015 Edition

**IMPORTANT NOTE:** This NFPA document is made available for use subject to important notices and legal disclaimers. These notices and disclaimers appear in all publications containing this document and may be found under the heading "Important Notices and Disclaimers Concerning NFPA Documents." They can also be obtained on request from NFPA or viewed at [www.nfpa.org/disclaimers](http://www.nfpa.org/disclaimers).

**NOTICE:** An asterisk (\*) following the number or letter designating a paragraph indicates that explanatory material on the paragraph can be found in Annex A.

A reference in brackets [ ] following a section or paragraph indicates material that has been extracted from another NFPA document. As an aid to the user, the complete title and edition of the source documents for extracts in the recommendations sections of this document are given in Chapter 2 and those for extracts in the informational sections are given in Annex I. Extracted text may be edited for consistency and style and may include the revision of internal paragraph references and other references as appropriate. Requests for interpretations or revisions of extracted text should be sent to the technical committee responsible for the source document.

Information on referenced publications can be found in Chapter 2 and Annex I.

## Chapter 1 Administration

## 1.1 Scope.

**1.1.1\*** This code shall apply to the storage, handling, and use of flammable and combustible liquids, including waste liquids, as herein defined and classified.

**1.1.2** This code shall not apply to the following:

- (1)\*Any liquid that has a melting point of 100°F (37.8°C) or greater
- (2)\*Any liquid that does not meet the criteria for fluidity given in the definition of *liquid* in Chapter 3 and in the provisions of Chapter 4
- (3) Any cryogenic fluid or liquefied gas, as defined in Chapter 3
- (4)\*Any liquid that does not have a flash point, but which is capable of burning under certain conditions
- (5)\*Any aerosol product
- (6) Any mist, spray, or foam
- (7)\*Transportation of flammable and combustible liquids as governed by the U.S. Department of Transportation
- (8)\*Storage, handling, and use of fuel oil tanks and containers connected with oil-burning equipment
- (9)\*Use and installation of alcohol-based hand rub (ABHR) dispensers

**1.2\* Purpose.** The purpose of this code shall be to provide fundamental safeguards for the storage, handling, and use of flammable and combustible liquids.

**1.3 Application.** The requirements in this code shall apply to users, producers, distributors, and others who are involved with the storage, handling, or use of flammable and combustible liquids.

**1.3.1** Chapters 1 through 7 shall apply to all facilities where flammable or combustible liquids are stored, handled, or used.

**1.3.2** Chapters 9 through 12 shall apply to the storage of flammable or combustible liquids in containers, portable tanks, and intermediate bulk containers in the occupancies covered by the scope of each chapter.

**1.3.3** Chapter 13 shall apply to the storage of flammable or combustible liquids in containers, portable tanks, and intermediate bulk containers in detached unprotected buildings.

**1.3.4** Chapter 14 shall apply to the storage of flammable or combustible liquids in containers, portable tanks, and intermediate bulk containers in hazardous materials storage lockers.

**1.3.5** Chapter 15 shall apply to the outdoor storage of flammable or combustible liquids in containers, portable tanks, and intermediate bulk containers.

**1.3.6** Chapter 16 shall apply to fire protection design criteria used to protect storage of flammable or combustible liquids in containers, portable tanks, and intermediate bulk containers.

**1.3.7** Chapter 17 shall apply to the design and construction of facilities where flammable or combustible liquids are processed or used.

**1.3.8** Chapter 18 shall apply to the general requirements related to handling, dispensing, transfer, and use of flammable or combustible liquids.

**1.3.9** Chapter 19 shall apply to specific equipment and specific operations that use flammable or combustible liquids.

**1.3.10** Chapters 21 through 25 shall apply to bulk storage of flammable or combustible liquids in tanks.

**1.3.11** Chapter 27 shall apply to piping systems for transferring flammable or combustible liquids.

**1.3.12** Chapter 28 shall apply to loading and unloading systems associated with bulk storage of flammable or combustible liquids in tanks.

**1.3.13** Chapter 29 shall apply to wharves associated with bulk handling of flammable or combustible liquids.

**1.4 Retroactivity.** The provisions of this code reflect a consensus of what is necessary to provide an acceptable degree of protection from the hazards addressed in this code at the time the code was issued.

**1.4.1** Unless otherwise specified, the provisions of this code shall not apply to facilities, equipment, structures, or installations that existed or were approved for construction or installation prior to the effective date of the code. Where specified, the provisions of this code shall be retroactive.

**1.4.2\*** In those cases where the authority having jurisdiction determines that the existing situation presents an unacceptable degree of risk, the authority having jurisdiction shall be permitted to apply retroactively any portion of this code deemed appropriate.

**1.4.3** The retroactive requirements of this code shall be permitted to be modified if their application clearly would be impractical in the judgment of the authority having jurisdiction, and only where it is clearly evident that a reasonable degree of safety is provided.



**1.5 Equivalency.** Nothing in this code is intended to prevent the use of systems, methods, or devices of equivalent or superior quality, strength, fire resistance, effectiveness, durability, and safety over those prescribed by this code. Technical documentation shall be submitted to the authority having jurisdiction to demonstrate equivalency. The system, method, or device shall be approved for the intended purpose by the authority having jurisdiction.

**1.5.1** The provisions of this code shall be permitted to be altered at the discretion of the authority having jurisdiction after consideration of special situations, such as topographical conditions of the site, presence or absence of protective features (e.g., barricades, walls, etc.), adequacy of building exits, the nature of the occupancy, proximity to buildings or adjoining property and the construction of such buildings, capacity and construction of proposed storage tanks and the nature of the liquids to be stored, the nature of the process, the degree to which private fire protection is provided, and the capabilities of the local fire department. Such alternate arrangements shall provide protection at least equivalent to that required by this code.

**1.5.2** The provisions of this code shall also be permitted to be altered at the discretion of the authority having jurisdiction in cases where other regulations, such as those for environmental protection, impose requirements that are not anticipated by this code. Such alternate arrangements shall provide protection at least equivalent to that required by this code.

**1.5.3** Installations made in accordance with the applicable requirements of the following standards shall be deemed to be in compliance with this code:

- (1) NFPA 1, *Fire Code*
- (2) NFPA 20, *Standard for the Installation of Stationary Pumps for Fire Protection*
- (3) NFPA 30A, *Code for Motor Fuel Dispensing Facilities and Repair Garages*
- (4) NFPA 31, *Standard for the Installation of Oil-Burning Equipment*
- (5) NFPA 32, *Standard for Drycleaning Plants*
- (6) NFPA 33, *Standard for Spray Application Using Flammable or Combustible Materials*
- (7) NFPA 34, *Standard for Dipping, Coating, and Printing Processes Using Flammable or Combustible Liquids*
- (8) NFPA 35, *Standard for the Manufacture of Organic Coatings*
- (9) NFPA 36, *Standard for Solvent Extraction Plants*
- (10) NFPA 37, *Standard for the Installation and Use of Stationary Combustion Engines and Gas Turbines*
- (11) NFPA 45, *Standard on Fire Protection for Laboratories Using Chemicals*
- (12) NFPA 99, *Health Care Facilities Code*
- (13) NFPA 101, *Life Safety Code*

### 1.6 Symbols, Units, and Formulas.

**1.6.1** The units of measure in this code are presented first in U.S. customary units (inch-pound units). SI units (International System of Units) follow the inch-pound units in parentheses.

**1.6.2** Either system of units shall be acceptable for satisfying the requirements in the code.

**1.6.3** Users of this code shall apply one system of units consistently and shall not alternate between units.

**1.6.4** The values presented for measurements in this code are expressed with a degree of precision appropriate for practical

application and enforcement. It is not intended that the application or enforcement of these values be more precise than the precision expressed.

**1.6.5** Where extracted text contains values expressed in only one system of units, the values in the extracted text have been retained without conversion to preserve the values established by the responsible technical committee in the source document.

**1.6.6** If a value for measurement given in this standard is followed by an equivalent value in other units, the first stated shall be regarded as the requirement. The given equivalent value shall be considered to be approximate.

### 1.7 Code Adoption Requirements. (Reserved)

### 1.8 Permits. (Reserved)

**1.9 Enforcement.** This code shall be administered and enforced by the authority having jurisdiction designated by the governing authority. (See Annex H for sample wording for enabling legislation.)

## Chapter 2 Referenced Publications

**2.1 General.** The documents or portions thereof listed in this chapter are referenced within this code and shall be considered part of the requirements of this document.

**2.2 NFPA Publications.** National Fire Protection Association, 1 Batterymarch Park, Quincy, MA 02169-7471.

NFPA 1, *Fire Code*, 2015 edition.

NFPA 10, *Standard for Portable Fire Extinguishers*, 2013 edition.

NFPA 11, *Standard for Low-, Medium-, and High-Expansion Foam*, 2010 edition.

NFPA 12, *Standard on Carbon Dioxide Extinguishing Systems*, 2011 edition.

NFPA 12A, *Standard on Halon 1301 Fire Extinguishing Systems*, 2009 edition.

NFPA 13, *Standard for the Installation of Sprinkler Systems*, 2013 edition.

NFPA 14, *Standard for the Installation of Standpipe and Hose Systems*, 2013 edition.

NFPA 15, *Standard for Water Spray Fixed Systems for Fire Protection*, 2012 edition.

NFPA 16, *Standard for the Installation of Foam-Water Sprinkler and Foam-Water Spray Systems*, 2011 edition.

NFPA 17, *Standard for Dry Chemical Extinguishing Systems*, 2013 edition.

NFPA 20, *Standard for the Installation of Stationary Pumps for Fire Protection*, 2013 edition.

NFPA 24, *Standard for the Installation of Private Fire Service Mains and Their Appurtenances*, 2013 edition.

NFPA 25, *Standard for the Inspection, Testing, and Maintenance of Water-Based Fire Protection Systems*, 2014 edition.

NFPA 30A, *Code for Motor Fuel Dispensing Facilities and Repair Garages*, 2015 edition.

NFPA 30B, *Code for the Manufacture and Storage of Aerosol Products*, 2015 edition.

NFPA 31, *Standard for the Installation of Oil-Burning Equipment*, 2011 edition.

NFPA 32, *Standard for Drycleaning Plants*, 2011 edition.

NFPA 33, *Standard for Spray Application Using Flammable or Combustible Materials*, 2011 edition.

NFPA 34, *Standard for Dipping, Coating, and Printing Processes Using Flammable or Combustible Liquids*, 2011 edition.

NFPA 35, *Standard for the Manufacture of Organic Coatings*, 2011 edition.

NFPA 36, *Standard for Solvent Extraction Plants*, 2013 edition.

NFPA 37, *Standard for the Installation and Use of Stationary Combustion Engines and Gas Turbines*, 2015 edition.

NFPA 45, *Standard on Fire Protection for Laboratories Using Chemicals*, 2011 edition.

NFPA 58, *Liquefied Petroleum Gas Code*, 2014 edition.

NFPA 59A, *Standard for the Production, Storage, and Handling of Liquefied Natural Gas (LNG)*, 2013 edition.

NFPA 68, *Standard on Explosion Protection by Deflagration Venting*, 2013 edition.

NFPA 69, *Standard on Explosion Prevention Systems*, 2014 edition.

NFPA 70<sup>®</sup>, *National Electrical Code*<sup>®</sup>, 2014 edition.

NFPA 80, *Standard for Fire Doors and Other Opening Protectives*, 2013 edition.

NFPA 85, *Boiler and Combustion Systems Hazards Code*, 2011 edition.

NFPA 91, *Standard for Exhaust Systems for Air Conveying of Vapors, Gases, Mists, and Noncombustible Particulate Solids*, 2010 edition.

NFPA 96, *Standard for Ventilation Control and Fire Protection of Commercial Cooking Operations*, 2014 edition.

NFPA 99, *Health Care Facilities Code*, 2015 edition.

NFPA 101<sup>®</sup>, *Life Safety Code*<sup>®</sup>, 2015 edition.

NFPA 220, *Standard on Types of Building Construction*, 2015 edition.

NFPA 221, *Standard for High Challenge Fire Walls, Fire Walls, and Fire Barrier Walls*, 2015 edition.

NFPA 303, *Fire Protection Standard for Marinas and Boatyards*, 2011 edition.

NFPA 307, *Standard for the Construction and Fire Protection of Marine Terminals, Piers, and Wharves*, 2011 edition.

NFPA 326, *Standard for the Safeguarding of Tanks and Containers for Entry, Cleaning, or Repair*, 2010 edition.

NFPA 505, *Fire Safety Standard for Powered Industrial Trucks Including Type Designations, Areas of Use, Conversions, Maintenance, and Operations*, 2013 edition.

NFPA 704, *Standard System for the Identification of the Hazards of Materials for Emergency Response*, 2012 edition.

NFPA 750, *Standard on Water Mist Fire Protection Systems*, 2015 edition.

NFPA 2001, *Standard on Clean Agent Fire Extinguishing Systems*, 2012 edition.

NFPA 5000<sup>®</sup>, *Building Construction and Safety Code*<sup>®</sup>, 2015 edition.

## 2.3 Other Publications.

**2.3.1 API Publications.** American Petroleum Institute, 1220 L Street, NW, Washington, DC 20005-4070.

API Specification 12B, *Bolted Tanks for Storage of Production Liquids*, 15th edition, 2008.

API Specification 12D, *Field Welded Tanks for Storage of Production Liquids*, 11th edition, 2008.

API Specification 12F, *Shop Welded Tanks for Storage of Production Liquids*, 12th edition, 2008.

API 620, *Recommended Rules for the Design and Construction of Large, Welded, Low-Pressure Storage Tanks*, 11th edition, Addendum 2, 2010.

API Standard 650, *Welded Steel Tanks for Oil Storage*, 11th edition, Addendum 2, 2009.

API Standard 653, *Tank Inspection, Repair, Alteration, and Reconstruction*, 4th edition, 2012.

API Standard 2000, *Venting Atmospheric and Low-Pressure Storage Tanks*, 5th edition, 1998.

API 2350, *Overfill Protection for Storage Tanks in Petroleum Facilities*, 4th edition, 2012.

**2.3.2 ASME Publications.** American Society of Mechanical Engineers, Two Park Avenue, New York, NY 10016-5990.

ASME *Boiler and Pressure Vessel Code*, 2010.

ASME B31, *Code for Process Piping*, 2012.

ASME *Code for Unfired Pressure Vessels*, 2010.

**2.3.3 ASTM Publications.** ASTM International, 100 Barr Harbor Drive, P.O. Box C700, West Conshohocken, PA 19428-2959.

ASTM A 395/A395M, *Standard Specification for Ferritic Ductile Iron Pressure-Retaining Castings for Use at Elevated Temperatures*, 1999 (reaffirmed 2009).

ASTM D 5/D5M, *Standard Test Method for Penetration of Bituminous Materials*, 2013.

ASTM D 56, *Standard Test Method for Flash Point by Tag Closed Cup Tester*, 2005 (reaffirmed 2010).

ASTM D 86, *Standard Test Method for Distillation of Petroleum Products at Atmospheric Pressure*, 2012.

ASTM D 92, *Standard Test Method for Flash and Fire Points by Cleveland Open Cup Tester*, 2012b.

ASTM D 93, *Standard Test Methods for Flash Point by Pensky-Martens Closed Cup Tester*, 2012.

ASTM D 323, *Standard Test Method for Vapor Pressure of Petroleum Products (Reid Method)*, 2008.

ASTM D 3278, *Standard Test Methods for Flash Point of Liquids by Small Scale Closed-Cup Apparatus*, 1996 (reaffirmed 2011).

ASTM D 3828, *Standard Test Methods for Flash Point by Small Scale Closed Cup Tester*, 2012a.

ASTM D 4359, *Standard Test for Determining Whether a Material is a Liquid or a Solid*, 1990 (reaffirmed 2012).

ASTM E 119, *Standard Test Methods for Fire Tests of Building Construction and Materials*, 2012a.

ASTM F 852, *Standard Specification for Portable Gasoline Containers for Consumer Use*, 2008.

ASTM F 976, *Specification for Portable Kerosine and Diesel Containers for Consumer Use*, 2008.

**2.3.4 CSA America Publications.** Canadian Standards Association, 5060 Spectrum Way, Mississauga, ON, L4W 5N6, Canada.

CSA B51, *Boiler, Pressure Vessel and Pressure Piping Code*, 2009.

**2.3.5 FM Publications.** FM Global, 1301 Atwood Avenue, P.O. Box 7500, Johnston, RI 02919.

*Approval Standard for Intermediate Bulk Containers*, Class Number 6020, December 2010.



*Approval Standard for Plastic Plugs for Steel Drums*, Class Number 6083, October 2006.

**2.3.6 NMFTA Publications.** National Motor Freight Traffic Association, 1001 North Fairfax Street, Suite 600, Alexandria, VA 22314.

*National Motor Freight Classification (NMFC)*, 2012.

**2.3.7 NRFC Publications.** National Railroad Freight Committee, 222 South Riverside Plaza, Chicago, IL 60606-5945.

Uniform Freight Classification (UFC), 2005.

**2.3.8 STI Publications.** Steel Tank Institute, 570 Oakwood Road, Lake Zurich, IL 60047.

STI SP001, *Standard for the Inspection of Aboveground Storage Tanks*, 5th edition, 2011.

**2.3.9 UL Publications.** Underwriters Laboratories Inc., 333 Pfingsten Road, Northbrook, IL 60062-2096.

ANSI/UL 30, *Standard for Metal Safety Cans*, 1995, Revised 2009.

UL 58, *Standard for Steel Underground Tanks for Flammable and Combustible Liquids*, 1996, Revised 1998.

ANSI/UL 80, *Standard for Steel Tanks for Oil-Burner Fuels and Other Combustible Liquids*, 2007, Revised 2009.

ANSI/UL 142, *Standard for Steel Aboveground Tanks for Flammable and Combustible Liquids*, 2006, Revised 2010.

UL 971, *Standard for Nonmetallic Underground Piping for Flammable Liquids*, 1995, Revised 2006.

ANSI/UL 499, *Electric Heating Appliances*, 2008.

ANSI/UL 1313, *Standard for Nonmetallic Safety Cans for Petroleum Products*, 1993, Revised 2007.

ANSI/UL 1316, *Standard for Glass-Fiber Reinforced Plastic Underground Storage Tanks for Petroleum Products, Alcohols, and Alcohol-Gasoline Mixtures*, 2006.

ANSI/UL 1746, *Standard for External Corrosion Protection Systems for Steel Underground Storage Tanks*, 2007.

UL 2080, *Standard for Fire Resistant Tanks for Flammable and Combustible Liquids*, 2000.

ANSI/UL 2085, *Standard for Protected Aboveground Tanks for Flammable and Combustible Liquids*, 1997, Revised 2010.

ANSI/UL 2208, *Standard for Solvent Distillation Units*, 2005, Revised 2011.

ANSI/UL 2245, *Standard for Below-Grade Vaults for Flammable Liquid Storage Tanks*, 2006.

UL 2368, *Standard for Fire Exposure Testing of Intermediate Bulk Containers for Flammable and Combustible Liquids*, 2012.

**2.3.10 UN Publications.** United Nations, Headquarters, New York, NY 10017.

*Recommendations on the Transport of Dangerous Goods*, 17th revised edition, 2011.

**2.3.11 U.S. Government Publications.** U.S. Government Printing Office, Washington, DC 20402.

Title 33, Code of Federal Regulations, "Navigation and Navigable Waters," Parts 154, 155, and 156.

Title 46, Code of Federal Regulations, "Shipping," Parts 30, 32, 35, and 39.

Title 49, Code of Federal Regulations, "Transportation," Parts 100-199.

**2.3.12 Other Publications.** *Merriam-Webster's Collegiate Dictionary*, 11th edition, Merriam-Webster, Inc., Springfield, MA, 2003.

#### 2.4 References for Extracts in Mandatory Sections.

NFPA 52, *Vehicular Gaseous Fuel Systems Code*, 2013 edition.

NFPA 55, *Compressed Gases and Cryogenic Fluids Code*, 2013 edition.

NFPA 77, *Recommended Practice on Static Electricity*, 2014 edition.

NFPA 101<sup>®</sup>, *Life Safety Code*<sup>®</sup>, 2015 edition.

NFPA 307, *Standard for the Construction and Fire Protection of Marine Terminals, Piers, and Wharves*, 2011 edition.

NFPA 400, *Hazardous Materials Code*, 2013 edition.

NFPA 5000<sup>®</sup>, *Building Construction and Safety Code*<sup>®</sup>, 2015 edition.

## Chapter 3 Definitions

**3.1 General.** The definitions contained in this chapter shall apply to the terms used in this code. Where terms are not defined in this chapter or within another chapter, they shall be defined using their ordinarily accepted meanings within the context in which they are used. *Merriam-Webster's Collegiate Dictionary*, 11th edition, shall be the source for the ordinarily accepted meaning.

### 3.2 NFPA Official Definitions.

**3.2.1\* Approved.** Acceptable to the authority having jurisdiction.

**3.2.2\* Authority Having Jurisdiction (AHJ).** An organization, office, or individual responsible for enforcing the requirements of a code or standard, or for approving equipment, materials, an installation, or a procedure.

**3.2.3\* Code.** A standard that is an extensive compilation of provisions covering broad subject matter or that is suitable for adoption into law independently of other codes and standards.

**3.2.4 Labeled.** Equipment or materials to which has been attached a label, symbol, or other identifying mark of an organization that is acceptable to the authority having jurisdiction and concerned with product evaluation, that maintains periodic inspection of production of labeled equipment or materials, and by whose labeling the manufacturer indicates compliance with appropriate standards or performance in a specified manner.

**3.2.5\* Listed.** Equipment, materials, or services included in a list published by an organization that is acceptable to the authority having jurisdiction and concerned with evaluation of products or services, that maintains periodic inspection of production of listed equipment or materials or periodic evaluation of services, and whose listing states that either the equipment, material, or service meets appropriate designated standards or has been tested and found suitable for a specified purpose.

### 3.3 General Definitions.

**3.3.1 Alcohol-Based Hand Rub (ABHR).** An alcohol-containing preparation designed for application to the hands for reducing the number of visible microorganisms on the hands and containing ethanol or isopropanol in an amount not exceeding 95 percent by volume.

#### 3.3.2 Area.

**3.3.2.1 Control Area.** For the purpose of this code, a building or portion of a building within which flammable and combustible liquids are allowed to be stored, dispensed, and used or handled in quantities that do not exceed the maximum allowable quantity (MAQ). (See also 3.3.38, *Maximum Allowable Quantity*.)

**3.3.2.2 Fire Area.** An area of a building separated from the remainder of the building by construction having a fire resistance of at least 1 hour and having all communicating openings properly protected by an assembly having a fire resistance rating of at least 1 hour.

**3.3.2.3 Inside Liquid Storage Area.** A room or building used for the storage of liquids in containers or portable tanks, separated from other types of occupancies.

**3.3.3 Barrel.** A unit of volume used in the petroleum industry that is equal to 42 gal (159 L).

**3.3.4 Basement.** For the purposes of this code, a story of a building or structure having one-half or more of its height below ground level and to which access for fire-fighting purposes is restricted.

**3.3.5 Boiling Point.** The temperature at which the vapor pressure of a liquid equals the surrounding atmospheric pressure.

**3.3.6\* Boil-Over.** An event in the burning of certain oils in an open-top tank when, after a long period of quiescent burning, there is a sudden increase in fire intensity associated with expulsion of burning oil from the tank.

**3.3.7 Bonding.** For the purpose of controlling static electric hazards, the process of connecting two or more conductive objects together by means of a conductor so that they are at the same electrical potential, but not necessarily at the same potential as the earth. [77, 2014]

**3.3.8 Building.** Any structure used or intended for supporting or sheltering any use or occupancy.

**3.3.8.1\* Important Building.** A building that is considered not expendable in an exposure fire.

**3.3.8.2 Storage Tank Building.** A three-dimensional space that is enclosed by a roof and walls that cover more than one-half of the possible area of the sides of the space, is of sufficient size to allow entry by personnel, will likely limit the dissipation of heat or dispersion of vapors, and restricts access for fire fighting.

**3.3.9 Building Code.** The building or construction code adopted by the jurisdiction. [55, 2013]

**3.3.10 Chemical Plant.** A large integrated plant or that portion of such a plant, other than a refinery or distillery, where liquids are produced by chemical reactions or used in chemical reactions.

**3.3.11 Closed-Top Diking.** A dike with a cover intended to minimize the entrance of precipitation into the diked area.

**3.3.12\* Container.** Any vessel of 119 gal (450 L) or less capacity used for transporting or storing liquids.

**3.3.12.1 Closed Container.** A container as herein defined, so sealed by means of a lid or other device that neither liquid nor vapor will escape from it at ordinary temperatures.

**3.3.12.2 Intermediate Bulk Container.** Any closed vessel having a liquid capacity not exceeding 3000 L (793 gal) and intended for storing and transporting liquids, as defined in Title 49, Code of Federal Regulations, Parts 100 through 199 or in Part 6 of the United Nations' *Recommendations on the Transport of Dangerous Goods*.

**3.3.12.3\* Nonmetallic Container.** A container as defined in 3.3.12, constructed of glass, plastic, fiber, or a material other than metal.

**3.3.12.4\* Nonmetallic Intermediate Bulk Container.** An intermediate bulk container, as defined in 3.3.12.2, constructed of glass, plastic, fiber, or a material other than metal.

**3.3.13 Crude Petroleum.** Hydrocarbon mixtures that have a flash point below 150°F (65.6°C) and that have not been processed in a refinery.

**3.3.14 Cryogenic Fluid.** A fluid with a boiling point lower than -130°F (-90°C) at an absolute pressure of 14.7 psi (101.325 kPa). [55, 2013]

**3.3.15 Damage-Limiting Construction.** For the purposes of this code, any set of construction elements, used individually or in combination, which will act to limit damage from an explosion, including open structures, pressure relieving construction, or pressure resistant construction.

**3.3.16 Distillery.** A plant or that portion of a plant where liquids produced by fermentation are concentrated and where the concentrated products are also mixed, stored, or packaged.

#### 3.3.17 Dwelling.

**3.3.17.1 Multifamily Dwelling.** A building that contains three or more dwelling units.

**3.3.17.2 One-Family Dwelling.** A building that consists solely of one dwelling unit.

**3.3.17.3 Two-Family Dwelling.** A building that consists solely of two dwelling units.

**3.3.18 Dwelling Unit.** One or more rooms arranged for complete, independent housekeeping purposes, with space for eating, living, and sleeping; facilities for cooking; and provisions for sanitation. [5000, 2015]

**3.3.19 Fire Code.** The fire code referenced in Chapter 2 of this code.

**3.3.20 Fire Point.** The lowest temperature at which a liquid will ignite and achieve sustained burning when exposed to a test flame in accordance with ASTM D 92, *Standard Test Method for Flash and Fire Points by Cleveland Open Cup Tester*.

**3.3.21 Flash Point.** The minimum temperature of a liquid at which sufficient vapor is given off to form an ignitable mixture with the air, near the surface of the liquid or within the vessel used, as determined by the appropriate test procedure and apparatus specified in Section 4.4.

**3.3.22\* Fugitive Emissions.** Releases of flammable vapor that continuously or intermittently occur from process equipment during normal operations.



**3.3.23 Grounding.** The process of bonding one or more conductive objects to the ground, so that all objects are at zero (0) electrical potential; also referred to as *earthing*. [77, 2014]

**3.3.24\* Hazardous Material or Hazardous Chemical.** Material presenting dangers beyond the fire problems relating to flash point and boiling point.

**3.3.25 Hazardous Materials Storage Locker.** A movable pre-fabricated structure, manufactured primarily at a site other than the final location of the structure and transported completely assembled or in a ready-to-assemble package to the final location, and intended to meet local, state, and federal requirements for outside storage of hazardous materials.

**3.3.26\* Hazardous Reaction or Hazardous Chemical Reaction.** Reactions that result in dangers beyond the fire problems relating to flash point and boiling point of either the reactants or of the products.

**3.3.27 Heat Transfer Fluid (HTF).** A liquid that is used as a medium to transfer heat energy from a heater or vaporizer to a remote heat consumer (e.g., injection molding machine, oven, or dryer, or jacketed chemical reactor).

**3.3.28 High Hazard Level 2 Contents.** Contents that present a deflagration hazard or a hazard from accelerated burning. For the purposes of this code, this includes Class I, Class II, or Class IIIA liquids that are used or stored in normally open containers or systems, or in closed containers or systems at gauge pressures 15 psi (103 kPa) or greater.

**3.3.29 High Hazard Level 3 Contents.** Contents that readily support combustion or that present a physical hazard. For the purposes of this code, this includes Class I, Class II, or Class IIIA liquids that are used or stored in normally closed containers or in closed systems at gauge pressures of less than 15 psi (103 kPa).

**3.3.30 Hotel.** A building or groups of buildings under the same management in which there are sleeping accommodations for more than 16 persons and primarily used by transients for lodging with or without meals. [101, 2015]

**3.3.31 Incidental Liquid Use or Storage.** Use or storage as a subordinate activity to that which establishes the occupancy or area classification.

**3.3.32 Liquefied Gas.** A gas, other than in solution, that in a packaging under the charged pressure exists both as a liquid and a gas at a temperature of 68°F (20°C).

**3.3.33 Liquid.** Any material that (1) has a fluidity greater than that of 300 penetration asphalt when tested in accordance with ASTM D 5, *Standard Test Method for Penetration of Bituminous Materials*, or (2) is a viscous substance for which a specific melting point cannot be determined but that is determined to be a liquid in accordance with ASTM D 4359, *Standard Test for Determining Whether a Material is a Liquid or a Solid*.

**3.3.33.1 Combustible Liquid.** Any liquid that has a closed-cup flash point at or above 100°F (37.8°C), as determined by the test procedures and apparatus set forth in Section 4.4. Combustible liquids are classified according to Section 4.3.

**3.3.33.2\* Flammable Liquid.** Any liquid that has a closed-cup flash point below 100°F (37.8°C), as determined by the test procedures and apparatus set forth in Section 4.4, and a Reid vapor pressure that does not exceed an absolute pressure of 40 psi (276 kPa) at 100°F (37.8°C), as deter-

mined by ASTM D 323, *Standard Test Method for Vapor Pressure of Petroleum Products (Reid Method)*. Flammable liquids are classified according to Section 4.3.

**3.3.33.3 Stable Liquid.** Any liquid not defined as unstable.

**3.3.33.4\* Unstable Liquid.** A liquid that, in the pure state or as commercially produced or transported, will vigorously polymerize, decompose, undergo condensation reaction, or become self-reactive under conditions of shock, pressure, or temperature.

**3.3.33.5\* Water-Miscible Liquid.** A liquid that mixes in all proportions with water without the use of chemical additives, such as emulsifying agents.

**3.3.34 Liquid Storage Room.** A room that is used for the storage of liquids in containers, portable tanks, or intermediate bulk containers, has a floor area that does not exceed 500 ft<sup>2</sup> (46 m<sup>2</sup>), and might be totally enclosed within a building — that is, the room might have no exterior walls.

**3.3.35 Liquidtight.** The ability of an enclosure or device to prevent the unintended release of liquids at normal operating temperature and pressure ranges.

**3.3.36 Liquid Warehouse.** See 3.3.62.2.

**3.3.37 Lower Flammable Limit (LFL).** That concentration of a flammable vapor in air below which ignition will not occur. Also known as the lower explosive limit (LEL).

**3.3.38\* Maximum Allowable Quantity (MAQ).** For the purposes of this code, the quantity of flammable and combustible liquid permitted in a control area.

**3.3.39 Occupancy.** The purpose for which a building or other structure, or part thereof, is used or intended to be used. [101, 2015]

**3.3.39.1 Ambulatory Health Care Occupancy.** [A building or portion thereof] used to provide services or treatment simultaneously to four or more patients that provides, on an outpatient basis, one or more of the following: (1) treatment for patients that renders the patients incapable of taking action for self-preservation under emergency conditions without the assistance of others; (2) anesthesia that renders the patients incapable of taking action for self-preservation under emergency conditions without the assistance of others; (3) emergency or urgent care for patients who, due to the nature of their injury or illness, are incapable of taking action for self-preservation under emergency conditions without the assistance of others. [101, 2015]

**3.3.39.2 Assembly Occupancy.** An occupancy (1) used for a gathering of 50 or more persons for deliberation, worship, entertainment, eating, drinking, amusement, awaiting transportation, or similar uses; or (2) used as a special amusement building, regardless of occupant load. [101, 2015]

**3.3.39.3 Business Occupancy.** An occupancy used for the transaction of business other than mercantile. [101, 2015]

**3.3.39.4 Day-Care Occupancy.** An occupancy in which four or more clients receive care, maintenance, and supervision, by other than their relatives or legal guardians, for less than 24 hours per day. [101, 2015]

**3.3.39.5 Detention and Correctional Occupancy.** An occupancy used to house [four] or more persons under varied

degrees of restraint or security where such occupants are mostly incapable of self-preservation because of security measures not under the occupants' control. [101, 2015]

**3.3.39.6 Educational Occupancy.** An occupancy used for educational purposes through the twelfth grade by six or more persons for 4 or more hours per day or more than 12 hours per week. [101, 2015]

**3.3.39.7 Health Care Occupancy.** An occupancy used to provide medical or other treatment or care simultaneously to four or more patients on an inpatient basis, where such patients are mostly incapable of self-preservation due to age, physical or mental disability, or because of security measures not under the occupants' control. [101, 2015]

**3.3.39.8 Industrial Occupancy.** An occupancy in which products are manufactured or in which processing, assembling, mixing, packaging, finishing, decorating, or repair operations are conducted. [101, 2015]

**3.3.39.9 Mercantile Occupancy.** An occupancy used for the display and sale of merchandise. [101, 2015]

**3.3.39.10 Residential Occupancy.** An occupancy that provides sleeping accommodations for purposes other than health care or detention and correctional. [101, 2015]

**3.3.39.11 Residential Board and Care Occupancy.** An occupancy used for lodging and boarding of four or more residents, not related by blood or marriage to the owners or operators, for the purpose of providing personal care services. [101, 2015]

**3.3.39.12 Storage Occupancy.** An occupancy used primarily for the storage or sheltering of goods, merchandise, products, or vehicles. [101, 2015]

**3.3.40 Occupancy Classification.** The system of defining the predominant operating characteristic of a portion of a building or plant for purposes of applying relevant sections of this code.

**3.3.40.1 Outdoor Occupancy Classification.** The system of defining the predominant operating characteristic of an outdoor operation that is not enclosed in a building or shelter for purposes of applying relevant sections of this code.

**3.3.41\* Operating Unit (Vessel) or Process Unit (Vessel).** The equipment in which a unit operation or unit process is conducted. (See also 3.3.53, *Unit Operation or Unit Process*.)

**3.3.42 Operations.** A general term that includes, but is not limited to, the use, transfer, storage, and processing of liquids.

**3.3.43\* Pier.** A structure, usually of greater length than width and projecting from the shore into a body of water with direct access from land, that can be either open deck or provided with a superstructure. [307, 2011]

**3.3.44 Pressure Vessel.** A container or other component designed in accordance with the ASME *Boiler and Pressure Vessel Code* or CSA B51, *Boiler, Pressure Vessel and Pressure Piping Code*. [52, 2013]

**3.3.45\* Process or Processing.** An integrated sequence of operations.

**3.3.46 Protection for Exposures.** Fire protection for structures on property adjacent to liquid storage that is provided by (1) a public fire department or (2) a private fire brigade maintained on the property adjacent to the liquid storage, either of

which is capable of providing cooling water streams to protect the property adjacent to the liquid storage.

**3.3.47 Refinery.** A plant in which flammable or combustible liquids are produced on a commercial scale from crude petroleum, natural gasoline, or other hydrocarbon sources.

**3.3.48\* Safety Can.** A listed container of not more than 5.3 gal (20 L) capacity having a screen or strainer in each fill and pour opening and having a spring-closing lid and spout cover designed to safely relieve internal pressure when exposed to fire.

**3.3.49 Solvent Distillation Unit.** An appliance that distills a flammable or combustible liquid to remove contaminants and recover the liquid.

**3.3.50 Staging.** Temporary storage in a process area of liquids in containers, intermediate bulk containers, and portable tanks.

**3.3.51 Tank.**

**3.3.51.1 Aboveground Tank.** A storage tank that is installed above grade, at grade, or below grade without backfill.

**3.3.51.2\* Atmospheric Tank.** A storage tank that has been designed to operate at pressures from atmospheric through a gauge pressure of 1.0 psi (6.9 kPa) (i.e., 760 mm Hg through 812 mm Hg) measured at the top of the tank.

**3.3.51.3 Low-Pressure Tank.** For the purposes of this code, a storage tank designed to withstand an internal pressure above a gauge pressure of 1.0 psi (6.9 kPa) but not more than a gauge pressure of 15 psi (103 kPa) measured at the top of the tank.

**3.3.51.4 Portable Tank.** Any vessel having a liquid capacity over 60 gal (230 L) intended for storing liquids and not intended for fixed installation.

**3.3.51.4.1\* Nonmetallic Portable Tank.** A portable tank, as herein defined, constructed of plastic, fiber, or a material other than metal.

**3.3.51.5 Secondary Containment Tank.** A tank that has an inner and outer wall with an interstitial space (annulus) between the walls and that has a means for monitoring the interstitial space for a leak.

**3.3.51.6 Storage Tank.** Any vessel having a liquid capacity that exceeds 60 gal (230 L), is intended for fixed installation, and is not used for processing.

**3.3.52 Terminal.** That portion of a property where liquids are received by tank vessel, pipelines, tank car, or tank vehicle and are stored or blended in bulk for the purpose of distributing such liquids by tank vessel, pipeline, tank car, tank vehicle, portable tank, or container.

**3.3.53 Unit Operation or Unit Process.** A segment of a physical or chemical process that might or might not be integrated with other segments to constitute the manufacturing sequence.

**3.3.54 Vapor Pressure.** The pressure, measured in pounds per square inch, absolute (psia), exerted by a liquid, as determined by ASTM D 323, *Standard Test Method for Vapor Pressure of Petroleum Products (Reid Method)*.

**3.3.55 Vapor Processing Equipment.** Those components of a vapor processing system designed to process vapors or liquids captured during transfer or filling operations.

**3.3.56\* Vapor Processing System.** A system designed to capture and process vapors displaced during transfer or filling operations by use of mechanical or chemical means.



**3.3.57\* Vapor Recovery System.** A system designed to capture and retain, without processing, vapors displaced during transfer or filling operations.

**3.3.58 Vaportight.** The ability of an enclosure or device to prevent the unintended release of flammable vapor at normal operating temperature and pressure ranges.

**3.3.59 Vault.** An enclosure consisting of four walls, a floor, and a top for the purpose of containing a liquid storage tank and not intended to be occupied by personnel other than for inspection, repair, or maintenance of the vault, the storage tank, or related equipment.

**3.3.60 Vent.**

**3.3.60.1 Emergency Relief Vent.** An opening, construction method, or device that will automatically relieve excessive internal pressure due to an exposure fire.

**3.3.60.2 Normal Vent.** An opening, construction method, or device that allows the relief of excessive internal pressure or vacuum during normal storage and operations.

**3.3.61\* Ventilation.** For the purpose of this code, movement of air that is provided for the prevention of fire and explosion.

**3.3.62\* Warehouse.**

**3.3.62.1 General-Purpose Warehouse.** A separate, detached building or portion of a building used only for warehousing-type operations and classified as a “storage — low hazard” or “storage — ordinary hazard” occupancy by the building code and by NFPA 101, *Life Safety Code*.

**3.3.62.2 Liquid Warehouse.** A separate, detached building or an attached building that is used for warehousing-type operations for liquids and whose exterior wall comprises at least 25 percent of the building perimeter.

**3.3.63\* Wharf.** A structure at the shoreline that has a platform built along and parallel to a body of water with either an open deck or a superstructure. [307, 2011]

## Chapter 4 Definition and Classification of Liquids

### 4.1 Scope.

**4.1.1** This chapter shall establish a uniform system of defining and classifying flammable and combustible liquids for the purpose of proper application of this code.

**4.1.2** The definitions and classifications of this chapter shall apply to any liquid within the scope of and subject to the requirements of this code.

**4.2 Definitions Specific to Chapter 4.** For the purposes of this chapter and this code, the terms in this section shall have the definitions given.

**4.2.1\* Boiling Point.** The temperature at which the vapor pressure of a liquid equals the surrounding atmospheric pressure.

**4.2.1.1** For purposes of defining the boiling point, atmospheric pressure shall be considered to be an absolute pressure of 14.7 psi (101.4 kPa).

**4.2.1.2** For mixtures that do not have a constant boiling point, the 20 percent evaporated point of a distillation performed in accordance with ASTM D 86, *Standard Test Method*

*for Distillation of Petroleum Products at Atmospheric Pressure*, shall be considered to be the boiling point.

**4.2.2 Combustible Liquid.** Any liquid that has a closed-cup flash point at or above 100°F (37.8°C), as determined by the test procedures and apparatus set forth in Section 4.4. Combustible liquids are classified according to Section 4.3.

**4.2.3 Flammable Liquid.** Any liquid that has a closed-cup flash point below 100°F (37.8°C), as determined by the test procedures and apparatus set forth in Section 4.4 and a Reid vapor pressure that does not exceed an absolute pressure of 40 psi (276 kPa) at 100°F (37.8°C), as determined by ASTM D 323, *Standard Test Method for Vapor Pressure of Petroleum Products (Reid Method)*. Flammable liquids are classified according to Section 4.3. (See A.3.3.33.2.)

**4.2.4\* Flash Point.** The minimum temperature of a liquid at which sufficient vapor is given off to form an ignitable mixture with the air, near the surface of the liquid or within the vessel used, as determined by the appropriate test procedure and apparatus specified in Section 4.4.

**4.2.5 Liquid.** Any material that (1) has a fluidity greater than that of 300 penetration asphalt when tested in accordance with ASTM D 5, *Standard Test Method for Penetration of Bituminous Materials*, or (2) is a viscous substance for which a specific melting point cannot be determined but that is determined to be a liquid in accordance with ASTM D 4359, *Standard Test for Determining Whether a Material is a Liquid or a Solid*.

**4.2.6\* Vapor Pressure.** The pressure, measured in pounds per square inch, absolute (psia), exerted by a liquid, as determined by ASTM D 323, *Standard Test Method for Vapor Pressure of Petroleum Products (Reid Method)*.

**4.3\* Classification of Liquids.** Any liquid within the scope of this code and subject to the requirements of this code shall be classified in accordance with this section.

**4.3.1** Flammable liquids, as defined in 3.3.33.2 and 4.2.3, shall be classified as Class I liquids and shall be further subclassified in accordance with the following:

- (1) Class IA Liquid — Any liquid that has a flash point below 73°F (22.8°C) and a boiling point below 100°F (37.8°C)
- (2) Class IB Liquid — Any liquid that has a flash point below 73°F (22.8°C) and a boiling point at or above 100°F (37.8°C)
- (3) Class IC Liquid — Any liquid that has a flash point at or above 73°F (22.8°C), but below 100°F (37.8°C)

**4.3.2** Combustible liquids, as defined in 3.3.33.1 and 4.2.2, shall be classified in accordance with the following:

- (1) Class II Liquid — Any liquid that has a flash point at or above 100°F (37.8°C) and below 140°F (60°C)
- (2) Class III Liquid — Any liquid that has a flash point at or above 140°F (60°C)
  - (a) Class IIIA Liquid — Any liquid that has a flash point at or above 140°F (60°C), but below 200°F (93°C)
  - (b) Class IIIB Liquid — Any liquid that has a flash point at or above 200°F (93°C)

**4.4 Determination of Flash Point.** The flash point of a liquid shall be determined according to the methods specified in 4.4.1 through 4.4.4.

**4.4.1** Except as specified in 4.4.1.1, the flash point of a liquid having a viscosity below 5.5 centiStokes at 104°F (40°C) or



below 9.5 centiStokes at 77°F (25°C) shall be determined in accordance with ASTM D 56, *Standard Test Method for Flash Point by Tag Closed Cup Tester*.

**4.4.1.1** Cut-back asphalts, liquids that tend to form a surface film, and liquids that contain suspended solids shall not be tested in accordance with ASTM D 56, even if they otherwise meet the viscosity criteria. Such liquids shall be tested in accordance with 4.4.2.

**4.4.2** The flash point of a liquid having a viscosity of 5.5 centiStokes or more at 104°F (40°C) or 9.5 centiStokes or more at 77°F (25°C) or a flash point of 200°F (93.4°C) or higher shall be determined in accordance with ASTM D 93, *Standard Test Methods for Flash Point by Pensky-Martens Closed Cup Tester*.

**4.4.3** As an alternative, ASTM D 3278, *Standard Test Methods for Flash Point of Liquids by Small Scale Closed-Cup Apparatus*, shall be permitted to be used for paints, enamels, lacquers, varnishes, and related products and their components that have flash points between 32°F (0°C) and 230°F (110°C) and viscosities below 150 Stokes at 77°F (25°C).

**4.4.4** As an alternative, ASTM D 3828, *Standard Test Methods for Flash Point by Small Scale Closed Cup Tester*, shall be permitted to be used for materials other than those for which ASTM D 3278 is specifically required.

#### 4.5 Relationship to Other Classification Systems. (Reserved)

## Chapter 5 Reserved

### Chapter 6 Fire and Explosion Prevention and Risk Control

**6.1\* Scope.** This chapter shall apply to the hazards associated with storage, processing, handling, and use of liquids. This chapter shall also apply when specifically referenced by another chapter.

#### 6.2 Definitions Specific to Chapter 6. (Reserved)

**6.3\* Management of Fire and Explosion Hazards.** This chapter shall apply to the management methodology used to identify, evaluate, and control the hazards involved in the processing and handling of flammable and combustible liquids. These hazards include, but are not limited to, preparation, separation, purification, and change of state, energy content, or composition.

#### 6.4 Hazards Analysis.

**6.4.1 General.** Operations involving flammable and combustible liquids shall be reviewed to ensure that fire and explosion hazards are addressed by fire prevention, fire control, and emergency action plans.

*Exception No. 1: Operations where liquids are used solely for on-site consumption as fuels.*

*Exception No. 2: Operations where Class II or Class III liquids are stored in atmospheric tanks or transferred at temperatures below their flash points.*

*Exception No. 3: Mercantile occupancies, crude petroleum exploration, drillings, and well servicing operations, and normally unoccupied facilities in remote locations.*

**6.4.1.1\*** The extent of fire prevention and control that is provided shall be determined in consultation with the authority having jurisdiction or by means of an engineering evaluation of the operation and application of sound fire protection and process engineering principles. This evaluation shall include, but not be limited to, the following:

- (1) Analysis of the fire and explosion hazards of the operation
- (2) Analysis of emergency relief from process vessels, taking into consideration the properties of the materials used and the fire protection and control measures taken
- (3) Analysis of applicable facility design requirements in Chapters 17, 18, 19, 28, and 29
- (4) Analysis of applicable requirements for liquid handling, transfer, and use, as covered in Chapters 17, 18, 19, 28, and 29
- (5) Analysis of local conditions, such as exposure to and from adjacent properties and exposure to floods, earthquakes, and windstorms
- (6) Analysis of the emergency response capabilities of the local emergency services

**6.4.1.2\*** Storage, processing, handling, and use of Class II and Class III liquids heated at or above their flash point shall follow the requirements for Class I liquids, unless an engineering evaluation conducted in accordance with Chapter 6 justifies following the requirements for some other liquid class.

**6.4.2 Management of Change.** The hazards analysis shall be repeated whenever the hazards leading to a fire or explosion change significantly. Conditions that might require repeating a review shall include, but are not limited to, the following:

- (1) When changes occur in the materials in process
- (2) When changes occur in process equipment
- (3) When changes occur in process control
- (4) When changes occur in operating procedures or assignments

#### 6.5 Control of Ignition Sources.

**6.5.1 General.** Precautions shall be taken to prevent the ignition of flammable vapors by sources such as the following:

- (1) Open flames
- (2) Lightning
- (3) Hot surfaces
- (4) Radiant heat
- (5) Smoking
- (6) Cutting and welding
- (7) Spontaneous ignition
- (8)\*Frictional heat or sparks
- (9) Static electricity
- (10) Electrical sparks
- (11) Stray currents
- (12) Ovens, furnaces, and heating equipment

**6.5.2 Smoking.** Smoking shall be permitted only in designated and identified areas.

#### 6.5.3\* Hot Work.

**6.5.3.1** Welding, cutting, and similar spark-producing operations shall not be permitted in areas containing flammable liquids until a written permit authorizing such work has been issued.

**6.5.3.2** The permit shall be issued by a person in authority following inspection of the area to ensure that permit require-



ments have been implemented and will be followed until the job is completed.

#### 6.5.4\* Static Electricity.

**6.5.4.1** All equipment such as tanks, machinery, and piping shall be designed and operated to prevent electrostatic ignitions.

**6.5.4.2** All metallic equipment such as tanks, machinery, and piping where the potential exists for an ignitable mixture to be present shall be bonded and grounded.

**6.5.4.3** The bond and ground shall be physically applied or shall be inherently present by the nature of the installation.

**6.5.4.4** Any electrically isolated section of metallic piping or equipment shall be bonded and grounded to prevent hazardous accumulation of static electricity.

**6.5.4.5** All nonmetallic equipment and piping where the potential exists for an ignitable mixture to be present shall be designed and operated to prevent electrostatic ignition.

**6.5.5 Electrical Systems.** Design, selection, and installation of electrical wiring and electrical utilization equipment shall meet the requirements of Chapter 7.

#### 6.6 Detection and Alarm Systems and Procedures.

**6.6.1\*** An approved means for prompt notification of fire or emergency to those within the plant and to the available public or mutual aid fire department shall be provided.

**6.6.2** Those areas, including buildings, where a potential exists for a flammable liquid spill shall be monitored as appropriate. The following methods shall be permitted to be used:

- (1) Personnel observation or patrol
- (2) Process-monitoring equipment that would indicate a spill or leak could have occurred
- (3) Provision of gas detectors to continuously monitor the area where facilities are unattended

#### 6.7 Fire Protection and Fire Suppression Systems.

**6.7.1\*** This section identifies recognized fire protection and fire suppression systems and methods used to prevent or minimize the loss from fire or explosion in liquid-processing facilities. The application of one or a combination of these systems and methods as well as the use of fire-resistive materials shall be determined in accordance with Sections 6.3 and 6.4.

**6.7.2** A reliable water supply or other suitable fire control agent shall be available in pressure and quantity to meet the fire demands indicated by the specific hazards of liquids-processing operations, storage, or exposure.

**6.7.3\*** Permanent connections between the fire water system and any process system shall be prohibited, to prevent contamination of fire water with process fluids.

**6.7.4** Where required by this chapter, hydrants, with or without fixed monitor nozzles, shall be provided in accordance with NFPA 24, *Standard for the Installation of Private Fire Service Mains and Their Appurtenances*. The number and placement shall depend on the hazards of the facility.

**6.7.5** Where the need is indicated by the hazards of liquid processing, storage, or exposure as determined by Section 6.4, fixed protection shall be provided.

**6.7.6** Where provided, fire control systems shall be designed, installed, and maintained in accordance with the following NFPA standards, as applicable:

- (1) NFPA 11, *Standard for Low-, Medium-, and High-Expansion Foam*
- (2) NFPA 12, *Standard on Carbon Dioxide Extinguishing Systems*
- (3) NFPA 12A, *Standard on Halon 1301 Fire Extinguishing Systems*
- (4) NFPA 13, *Standard for the Installation of Sprinkler Systems*
- (5) NFPA 15, *Standard for Water Spray Fixed Systems for Fire Protection*
- (6) NFPA 16, *Standard for the Installation of Foam-Water Sprinkler and Foam-Water Spray Systems*
- (7) NFPA 17, *Standard for Dry Chemical Extinguishing Systems*
- (8) NFPA 750, *Standard on Water Mist Fire Protection Systems*
- (9) NFPA 2001, *Standard on Clean Agent Fire Extinguishing Systems*

**6.7.7** Where required by this chapter, standpipe and hose systems shall be installed in accordance with NFPA 14, *Standard for the Installation of Standpipe and Hose Systems*, or hose connections from sprinkler systems using combination spray and straight stream nozzles, shall be installed in accordance with NFPA 13, *Standard for the Installation of Sprinkler Systems*.

**6.7.8\*** Where required by this chapter, listed portable fire extinguishers shall be provided in such quantities, sizes, and types as are needed for the specific hazards of operation and storage.

**6.7.9** Where provided, mobile foam apparatus and supplies of foam concentrate shall be appropriate to the specific hazards.

#### 6.8 Emergency Planning and Training.

**6.8.1** A written emergency action plan that is consistent with available equipment and personnel shall be established to respond to fires and related emergencies. This plan shall include the following:

- (1) Procedures to be followed in case of fire or release of liquids or vapors, such as sounding the alarm, notifying the fire department, evacuating personnel, and controlling and extinguishing the fire
- (2) Procedures and schedules for conducting drills of these procedures
- (3) Appointment and training of personnel to carry out assigned duties, including review at the time of initial assignment, as responsibilities or response actions change, and whenever anticipated duties change
- (4) Procedures for maintenance and operation of (a) fire protection equipment and systems, (b) drainage and containment systems, and (c) dispersion and ventilation equipment and systems
- (5) Procedures for shutting down or isolating equipment to reduce, mitigate, or stop the release of liquid or vapors, including assigning personnel responsible for maintaining critical plant functions or shutdown of plant processes and safe start-up following isolation or shutdown
- (6) Alternate measures for the safety of occupants

**6.8.2** Personnel responsible for the use and operation of fire protection equipment shall be trained in the use of that equipment. Refresher training shall be conducted at least annually.

**6.8.3** Planning of effective fire control measures shall be coordinated with local emergency response agencies.

**6.8.4** Procedures shall be established to provide for safe shutdown of operations under emergency conditions and for safe start-up following cessation of emergencies. Provisions shall be made for training of personnel in shutdown and start-up procedures, and in activation, use, and deactivation of associated alarms, interlocks, and controls. Procedures shall also be established and provisions shall also be made for inspection and testing of associated alarms, interlocks, and controls.

**6.8.5** The emergency procedures shall be kept readily available in the operating areas and shall be updated when conditions change, as identified in 6.4.2.

**6.8.5.1** Where premises are likely to be unattended for considerable periods of time, a summary of the emergency plan shall be posted or located in a strategic and accessible location.

## **6.9 Inspection and Maintenance.**

**6.9.1** All fire protection equipment shall be properly maintained, and periodic inspections and tests shall be done in accordance with both standard practice and the equipment manufacturer's recommendations. Water-based fire protection systems shall be inspected, tested, and maintained in accordance with NFPA 25, *Standard for the Inspection, Testing, and Maintenance of Water-Based Fire Protection Systems*.

**6.9.2** Maintenance and operating practices shall be established and implemented to control leakage and prevent spillage of flammable and combustible liquids.

**6.9.3** Combustible waste material and residues in operating areas shall be kept to a minimum, stored in covered metal containers, and disposed of daily.

**6.9.4** Ground areas around facilities where liquids are stored, handled, or used shall be kept free of weeds, trash, or other unnecessary combustible materials.

**6.9.5** Aisles established for movement of personnel shall be kept clear of obstructions to permit orderly evacuation and ready access for manual fire-fighting activities.

## **6.10 Management of Security.**

### **6.10.1 Scope.**

**6.10.1.1** This section shall apply to the management methodology used to identify, evaluate, and control the security hazards involved in the processing and handling of flammable and combustible liquids.

**6.10.1.2** These hazards include, but are not limited to, vulnerability to terrorist or other malicious attacks.

**6.10.2 General.** The methodology used shall incorporate a risk-based approach to site security and shall have the following objectives:

- (1) Identification and evaluation of security risks
- (2) Evaluation of the security performance of the facility
- (3) Evaluation of protection for employees, the facility itself, the surrounding communities, and the environment. (*See Annex G for more detailed information.*)

### **6.10.3 Specific Requirements.**

**6.10.3.1** Operations involving flammable and combustible liquids shall be reviewed to ensure that security vulnerabilities identified during the security vulnerability analysis (SVA) are

addressed in a facility security program, with corresponding fire prevention and emergency action plans and drills.

**6.10.3.2** The balance of physical, electronic, and personnel techniques used to respond to the SVA shall be determined by means of an engineering evaluation of the operation and application of sound security principles. This evaluation shall include, but not be limited to, the following:

- (1) Assessing overall facility
- (2) Evaluating vulnerabilities
- (3) Assessing threats/consequences
- (4) Assessing physical factors/attractiveness
- (5) Identifying mitigation factors
- (6) Conducting security assessment or gap analysis

**6.10.3.3** A written emergency action plan that is consistent with available equipment and personnel shall be established to respond to fires, security, and related emergencies. This plan shall include the following:

- (1) Procedures to be followed such as initiating alarms, notifying appropriate agencies, evacuating personnel, and controlling and extinguishing the fire
- (2) Procedures and schedules for conducting drills of these procedures
- (3) Appointment and training of personnel to carry out assigned duties
- (4) Maintenance of fire protection and response equipment
- (5) Procedures for shutting down or isolating equipment to reduce the release of liquid
- (6) Alternate measures for the safety of occupants

**6.10.3.4** Specific duties of personnel shall be reviewed at the time of initial assignment, as responsibilities or response actions change, and whenever anticipated duties change.

**6.10.3.5** The security management review conducted in accordance with this section shall be repeated under the following conditions:

- (1) For an initial review of all new relevant facilities and assets
- (2) When substantial changes to the threat or process occur
- (3) After a significant security incident
- (4) For periodic revalidation of the SVA

## **Chapter 7 Electrical Systems**

**7.1 Scope.** This chapter shall apply to areas where Class I liquids are stored or handled and to areas where Class II or Class III liquids are stored or handled at or above their flash points.

### **7.2 Definitions Specific to Chapter 7. (Reserved)**

### **7.3 General Requirements.**

**7.3.1** Electrical utilization equipment and wiring shall not constitute a source of ignition for any ignitable vapor that might be present under normal operation or because of a spill. Compliance with 7.3.2 through 7.3.7.1 shall be deemed as meeting the requirements of this section.

**7.3.2** All electrical utilization equipment and wiring shall be of a type specified by and installed in accordance with NFPA 70, *National Electrical Code*.

**7.3.3\*** Table 7.3.3 shall be used to delineate and classify areas for the purpose of installation of electrical utilization equipment and wiring under normal operating conditions.



Table 7.3.3 Electrical Area Classifications

Location	NEC Class I		Extent of Classified Area
	Division	Zone	
Indoor equipment installed in accordance with Section 7.3 where flammable vapor-air mixtures can exist under normal operation	1	0	The entire area associated with such equipment where flammable gases or vapors are present continuously or for long periods of time
	1	1	Area within 5 ft of any edge of such equipment, extending in all directions
	2	2	Area between 5 ft and 8 ft of any edge of such equipment, extending in all directions; also, space up to 3 ft above floor or grade level within 5 ft to 25 ft horizontally from any edge of such equipment <sup>1</sup>
Outdoor equipment of the type covered in Section 7.3 where flammable vapor-air mixtures can exist under normal operation	1	0	The entire area associated with such equipment where flammable gases or vapors are present continuously or for long periods of time
	1	1	Area within 3 ft of any edge of such equipment, extending in all directions
	2	2	Area between 3 ft and 8 ft of any edge of such equipment, extending in all directions; also, space up to 3 ft above floor or grade level within 3 ft to 10 ft horizontally from any edge of such equipment
Tank storage installations inside buildings	1	1	All equipment located below grade level
	2	2	Any equipment located at or above grade level
Tank — aboveground, fixed roof	1	0	Inside fixed-roof tank
	1	1	Area inside dike where dike height is greater than the distance from the tank to the dike for more than 50 percent of the tank circumference
	2	2	Within 10 ft from shell, ends, or roof of tank; also, area inside dike up to top of dike wall
	1	0	Area inside of vent piping or vent opening
	2	2	Area between 5 ft and 10 ft from open end of vent, extending in all directions
Tank — aboveground, floating roof	1	0	Area between the floating and fixed-roof sections and within the shell
	1	1	Area above the floating roof and within the shell
Tank vault — interior	1	1	Entire interior volume, if Class I liquids are stored within
Underground tank fill opening	1	1	Any pit, box, or space below grade level, if any part is within a Division 1 or 2 or Zone 1 or 2 classified location
	2	2	Up to 18 in. above grade level within a horizontal radius of 10 ft from a loose fill connection and within a horizontal radius of 5 ft from a tight fill connection
Vent — discharging upward	1	0	Area inside of vent piping or opening
	1	1	Within 3 ft of open end of vent, extending in all directions
	2	2	Area between 3 ft and 5 ft of open end of vent, extending in all directions
Drum and container filling — outdoors or indoors	1	0	Area inside the drum or container
	1	1	Within 3 ft of vent and fill openings, extending in all directions
	2	2	Area between 3 ft and 5 ft from vent or fill opening, extending in all directions; also, up to 18 in. above floor or grade level within a horizontal radius of 10 ft from vent or fill opening
Pumps, bleeders, withdrawal fittings	2	2	Indoor Within 5 ft of any edge of such devices, extending in all directions; also, up to 3 ft above floor or grade level within 25 ft horizontally from any edge of such devices
	2	2	Outdoor Within 3 ft of any edge of such devices, extending in all directions; also, up to 18 in. above grade level within 10 ft horizontally from any edge of such devices

(continues)

Table 7.3.3 Continued

Location	NEC Class I		Extent of Classified Area
	Division	Zone	
Pits and sumps			
Without mechanical ventilation	1	1	Entire area within a pit or sump if any part is within a Division 1 or 2 or Zone 1 or 2 classified location
With adequate mechanical ventilation	2	2	Entire area within a pit or sump if any part is within a Division 1 or 2 or Zone 1 or 2 classified location
Containing valves, fittings, or piping, and not within a Division 1 or 2 or Zone 1 or 2 classified location	2	2	Entire pit or sump
Drainage ditches, separators, impounding basins			
Outdoor	2	2	Area up to 18 in. above ditch, separator, or basin; also, area up to 18 in. above grade within 15 ft horizontally from any edge
Indoor			Same as pits and sumps
Tank vehicle and tank car <sup>2</sup>			
Loading through open dome	1	0	Area inside of the tank
	1	1	Within 3 ft of edge of dome, extending in all directions
	2	2	Area between 3 ft and 15 ft from edge of dome, extending in all directions
Loading through bottom connections with atmospheric venting	1	0	Area inside of the tank
	1	1	Within 3 ft of point of venting to atmosphere, extending in all directions
	2	2	Area between 3 ft and 15 ft from point of venting to atmosphere, extending in all directions; also, up to 18 in. above grade within a horizontal radius of 10 ft from point of loading connection
Loading through closed dome with atmospheric venting	1	1	Within 3 ft of open end of vent, extending in all directions
	2	2	Area between 3 ft and 15 ft from open end of vent, extending in all directions; also, within 3 ft of edge of dome, extending in all directions
Loading through closed dome with vapor control	2	2	Within 3 ft of point of connection of both fill and vapor lines, extending in all directions
Bottom loading with vapor control or any bottom unloading	2	2	Within 3 ft of point of connections, extending in all directions; also, up to 18 in. above grade within a horizontal radius of 10 ft from point of connections
Storage and repair garage for tank vehicles	1	1	All pits or spaces below floor level
	2	2	Area up to 18 in. above floor or grade level for entire storage or repair garage
Garages for other than tank vehicles	Ordinary		If there is any opening to these rooms within the extent of an outdoor classified location, the entire room shall be classified the same as the area classification at the point of the opening
Outdoor drum storage	Ordinary		
Inside rooms or storage lockers used for the storage of Class I liquids	2	2	Entire room or locker
Indoor warehousing where there is no flammable liquid transfer	Ordinary		If there is any opening to these rooms within the extent of an indoor classified location, the classified location shall extend through the opening to the same extent as if the wall, curb, or partition did not exist
Office and rest rooms	Ordinary		If there is any opening to these rooms within the extent of an indoor classified location, the room shall be classified the same as if the wall, curb, or partition did not exist
Piers and wharves			See Figure 29.3.22.

For SI units, 1 in. = 25 mm; 1 ft = 0.3 m.

<sup>1</sup>The release of Class I liquids can generate vapors to the extent that the entire building, and possibly an area surrounding it, should be considered a Class I, Division 2, or Zone 2 location.

<sup>2</sup>When classifying extent of area, consideration should be given to the fact that tank cars or tank vehicles can be spotted at varying points. Therefore, the extremities of the loading or unloading positions should be used.



**7.3.4** A classified area shall not extend beyond a floor, wall, roof, or other solid partition that has no openings within the classified area.

**7.3.5** The designation of classes, divisions, and zones shall be as defined in Chapter 5 of *NFPA 70, National Electrical Code*.

**7.3.6** The area classifications listed in Table 7.3.3 are based on the premise that all applicable requirements of this code have been met; if this is not the case, the authority having jurisdiction shall have the authority to classify the extent of the area.

**7.3.7\*** Where the provisions of 7.3.1 through 7.3.6 require the installation of electrical equipment suitable for Class I, Division 1 or 2, or Zone 1 or 2 locations, ordinary electrical equipment, including switchgear, shall be permitted to be used if installed in a room or enclosure that is maintained under positive pressure with respect to the classified area.

**7.3.7.1** Ventilation make-up air shall be taken from an uncontaminated source.

#### **7.4 Application of Area Classification.**

**7.4.1** Area classification is used to assure that fixed electrical utilization equipment, electrical fixtures, and wiring are properly installed within Class I, Division 1; Class I, Zone 1; Class I, Division 2; or Class I, Zone 2 designated areas, as defined by Article 500 of *NFPA 70<sup>®</sup>, National Electrical Code<sup>®</sup>*.

## **Chapter 8 Reserved**

### **Chapter 9 Storage of Liquids in Containers — General Requirements**

#### **9.1 Scope.**

**9.1.1** This chapter shall apply to the storage of flammable and combustible liquids in:

- (1) Drums or other containers that do not exceed 119 gal (450 L) individual capacity
- (2) Portable tanks that do not exceed 660 gal (2500 L) individual capacity
- (3) Intermediate bulk containers that do not exceed 793 gal (3000 L)

**9.1.2** This chapter shall also apply to limited transfer of liquids incidental thereto.

**9.1.3** This chapter shall also apply to overpack drums when used for temporary containment of containers that do not exceed 60 gal (230 L) capacity. Such overpack containers shall be treated as containers as defined in 3.3.12.

**9.1.4** This chapter shall not apply to the following:

- (1) Containers, intermediate bulk containers, and portable tanks that are used in operations areas, as covered by Chapter 17
- (2) Liquids in the fuel tanks of motor vehicles, aircraft, boats, or portable or stationary engines
- (3) Beverages where packaged in individual containers that do not exceed 1.3 gal (5 L) capacity
- (4) Medicines, foodstuffs, cosmetics, and other consumer products that contain not more than 50 percent by volume of water-miscible flammable or combustible liquids,

- with the remainder of the product consisting of components that do not burn and where packaged in individual containers that do not exceed 1.3 gal (5 L) capacity
- (5) Liquids that have no fire point when tested in accordance with ASTM D 92, *Standard Test Method for Flash and Fire Points by Cleveland Open Cup Tester*, up to the boiling point of the liquid or up to a temperature at which the liquid shows an obvious physical change
- (6) Liquids with a flash point greater than 95°F (35°C) in a water-miscible solution or water-miscible dispersion with a water and noncombustible solids content of more than 80 percent by weight, and which does not sustain combustion when tested in accordance with “Method of Testing for Sustained Combustibility,” in accordance with 49 CFR 173, Appendix H, or the UN publication, *Recommendations on the Transport of Dangerous Goods*
- (7) Distilled spirits and wines in wooden barrels or casks

#### **9.2 Definitions Specific to Chapter 9. (Reserved)**

#### **9.3 General Requirements.**

**9.3.1** The general requirements of this chapter shall be applicable to the storage of liquids in liquid storage areas as covered in Chapters 10 through 14, regardless of the quantities being stored.

*Exception: Where more stringent requirements are set forth in Chapters 10 through 14, those requirements shall take precedence.*

**9.3.2** For the purposes of Chapters 9 through 16, unstable liquids shall be treated as Class IA liquids.

**9.3.3** Means of egress shall meet applicable requirements of *NFPA 101, Life Safety Code*.

**9.3.3.1** Storage of liquids shall not physically obstruct a means of egress.

**9.3.4** For the purposes of this chapter and Chapters 10, 12, and 16, *protected storage* shall mean storage installed after January 1, 1997 that is protected in accordance with Chapter 16. All other storage shall be considered to be unprotected storage unless an alternative means of protection has been approved by the authority having jurisdiction. (*See 16.3.5 and Section 16.9.*)

**9.3.5** Wood of at least 1 in. (25 mm) nominal thickness shall be permitted to be used for shelving, racks, dunnage, scuffboards, floor overlay, and similar installations.

**9.3.6** Class I liquids shall not be permitted to be stored in basements as defined in 3.3.4.

**9.3.7** Class II and Class IIIA liquids shall be permitted to be stored in basements as defined in 3.3.4, provided the basement is protected in accordance with Chapter 16.

**9.3.8** Class IIIB liquids shall be permitted to be stored in basements as defined in 3.3.4.

**9.3.9** Where containers, intermediate bulk containers, or portable tanks are stacked, they shall be stacked so that stability is maintained and excessive stress on container walls is prevented.

**9.3.9.1** Portable tanks and intermediate bulk containers stored more than one high shall be designed to stack securely, without the use of dunnage.

**9.3.9.2** Materials-handling equipment shall be capable of handling containers, portable tanks, and intermediate bulk containers that are stored at all storage levels.

**9.3.9.3\*** Power-operated industrial trucks used to move Class I liquids shall be selected, operated, and maintained in accordance with NFPA 505, *Fire Safety Standard for Powered Industrial Trucks Including Type Designations, Areas of Use, Conversions, Maintenance, and Operations*.

**9.3.10** Containers, intermediate bulk containers, and portable tanks in unprotected liquid storage areas shall not be stored closer than 36 in. (915 mm) to the nearest beam, chord, girder, or other roof or ceiling member.

**9.3.11** Liquids used for building maintenance, painting, or other similar infrequent maintenance purposes shall be permitted to be stored in closed containers outside of storage cabinets or inside liquid storage areas, if limited to an amount that does not exceed a 10-day supply at anticipated rates of use.

**9.3.12** Storage, handling, and use of Class II and Class III liquids heated at or above their flash point shall follow the requirements for Class I liquids, unless an engineering evaluation conducted in accordance with Chapter 6 justifies following the requirements for some other liquid class. (See 6.4.1.2 and A.6.4.1.2.)

#### 9.4 Acceptable Containers.

**9.4.1\*** Only the following approved containers, intermediate bulk containers, and portable tanks shall be used for Class I, Class II, and Class IIIA liquids:

- (1) Metal containers, metal intermediate bulk containers, and metal portable tanks meeting the requirements of and containing products authorized by the U.S. Department of Transportation Hazardous Materials Regulations in Title 49, Code of Federal Regulations, Parts 100–199, or by Part 6 of the UN *Recommendations on the Transport of Dangerous Goods*
- (2) Plastic or metal consumer-use containers meeting the requirements of, and used within the scope of, one or more of the following specifications:
  - (a) ASTM F 852, *Standard Specification for Portable Gasoline Containers for Consumer Use*
  - (b) ASTM F 976, *Standard Specification for Portable Kerosene and Diesel Containers for Consumer Use*
- (3) Nonmetallic or metallic commercial/industrial safety cans meeting the requirements of, and used within the scope of, one or more of the following specifications:
  - (a) ANSI/UL 30, *Standard for Metal Safety Cans*
  - (b) ANSI/UL 1313, *Standard for Nonmetallic Safety Cans for Petroleum Products*
  - (c) FM Global *Approval Standard for Safety Containers and Filling, Supply, and Disposal Containers* — Class Number 6051 and 6052
- (4) Plastic containers that meet requirements set by, and contain products authorized by, the following:
  - (a) The U.S. Department of Transportation Hazardous Materials Regulations in Title 49, Code of Federal Regulations, Parts 100–199, or by Part 6 of the UN publication, *Recommendations on the Transport of Dangerous Goods*
  - (b) Items 256 or 258 of the National Motor Freight Classification (NMFC) for liquids that are not classified as hazardous by the U.S. Department of Transportation Hazardous Materials Regulations in Title 49, Code of Federal Regulations, Parts 100–199, or by Part 6 of

the UN publication *Recommendations on the Transport of Dangerous Goods*

- (5) Fiber drums that meet the following:
  - (a) Requirements of Items 294 and 296 of the *National Motor Freight Classification* (NMFC) or of Rule 51 of the Uniform Freight Classification (UFC), for Types 2A, 3A, 3B-H, 3B-L, or 4A
  - (b) Requirements of, and containing liquid products authorized by, either the U.S. Department of Transportation Hazardous Materials Regulations in Title 49, Code of Federal Regulations, Chapter I, or by the U.S. Department of Transportation exemption
- (6)\*Rigid nonmetallic intermediate bulk containers that meet requirements set by, and contain products authorized by, the following:
  - (a) The U.S. Department of Transportation Hazardous Materials Regulations in Title 49, Code of Federal Regulations, Parts 100–199, or by Part 6 of the UN publication, *Recommendations on the Transport of Dangerous Goods*, for Classes 31H1, 31H2, and 31HZ1
  - (b) The *National Motor Freight Classification* (NMFC), or the International Safe Transit Association for liquids that are not classified as hazardous by the U.S. Department of Transportation Hazardous Materials Regulations in Title 49, Code of Federal Regulations, Parts 100–199, or by Part 6 of the UN publication *Recommendations on the Transport of Dangerous Goods*
- (7) Glass containers up to the capacity limits stated in Table 9.4.3 and in accordance with U.S. Department of Transportation Hazardous Materials Regulations in Title 49, Code of Federal Regulations, Parts 100–199

**9.4.1.1** For protected storage, rigid nonmetallic intermediate bulk containers, as described in 9.4.1(6), shall be subjected to a standard fire test that demonstrates acceptable inside storage fire performance and shall be listed and labeled.

**9.4.1.2** Medicines, beverages, foodstuffs, cosmetics, and other common consumer products, where packaged according to commonly accepted practices for retail sales, shall be exempt from the requirements of 9.4.1 and 9.4.3.

**9.4.2** Each portable tank or intermediate bulk container shall be provided with one or more devices installed in the top with sufficient emergency venting capacity to limit internal pressure under fire exposure conditions to a gauge pressure of 10 psi (70 kPa) or 30 percent of the bursting pressure of the portable tank, whichever is greater.

**9.4.2.1** The total venting capacity shall be not less than that specified in 22.7.3.2 or 22.7.3.4.

**9.4.2.2** At least one pressure-actuated vent having a minimum capacity of 6000 ft<sup>3</sup> (170 m<sup>3</sup>) of free air per hour at an absolute pressure of 14.7 psi (101 kPa) and 60°F (15.6°C) shall be used. The vent shall be set to open at not less than a gauge pressure of 5 psi (35 kPa).

**9.4.2.3** If fusible vents are used, they shall be actuated by elements that operate at a temperature not exceeding 300°F (150°C). Where plugging of a pressure-actuated vent can occur, such as when used for paints, drying oils, and similar materials, fusible plugs or venting devices that soften to failure at a maximum of 300°F (150°C) under fire exposure shall be permitted to be used for the entire emergency venting requirement.



**9.4.3** The maximum allowable size of a container, intermediate bulk container, or metal portable tank for Class I, Class II, and Class IIIA liquids shall not exceed that specified in Table 9.4.3.

*Exception:* As provided for in Section 9.1, 9.4.3.1, 9.4.3.2, and 9.4.3.3.

**9.4.3.1** Class IB and Class IC water-miscible liquids shall be permitted to be stored in plastic containers up to 60 gal (230 L) in size, if stored and protected in accordance with Table 16.5.2.7.

**9.4.3.2** Class IA and Class IB liquids shall be permitted to be stored in glass containers of not more than 1.3 gal (5 L) capacity if the required liquid purity (such as American Chemical Society analytical reagent grade or higher) would be affected by storage in metal containers or if the liquid can cause excessive corrosion of a metal container.

**9.4.3.3** Leaking or damaged containers up to 60 gal (230 L) capacity shall be permitted to be stored temporarily in accordance with this chapter and Chapters 10 through 12, provided they are enclosed in overpack containers.

**9.4.3.3.1** To be considered protected storage as defined in 9.3.4 and in accordance with Chapter 16, an overpack container shall be constructed of the same material as the leaking or damaged container.

**9.4.3.3.2** Metal overpack containers shall be considered non-relieving style containers.

#### **9.5\* Flammable Liquids Storage Cabinets.**

**9.5.1** The volume of Class I, Class II, and Class IIIA liquids stored in an individual storage cabinet shall not exceed 120 gal (460 L).

**9.5.2** The total aggregate volume of Class I, Class II, and Class IIIA liquids in a group of storage cabinets shall not exceed the maximum allowable quantity of flammable and combustible liquids per control area based on the occupancy where the cabinets are located.

**9.5.3** Storage cabinets that meet at least one of the following sets of requirements shall be acceptable for storage of liquids:

- (1) Storage cabinets designed and constructed to limit the internal temperature at the center of the cabinet and 1 in. (25 mm) from the top of the cabinet to not more than 325°F (163°C), when subjected to a 10-minute fire test that simulates the fire exposure of the standard time-temperature curve specified in ASTM E 119, *Standard Test Methods for Fire Tests of Building Construction and Materials*, shall be acceptable. All joints and seams shall remain tight and the door shall remain securely closed during the test.

**Table 9.4.3 Maximum Allowable Size — Containers, Intermediate Bulk Containers (IBCs), and Portable Tanks**

Container Type	Flammable Liquids			Combustible Liquids	
	Class IA	Class IB	Class IC	Class II	Class IIIA
Glass	1 pt (0.5 L)	1 qt (1 L)	1.3 gal (5 L)	1.3 gal (5 L)	5.3 gal (20 L)
Metal (other than drums) or approved plastic	1.3 gal (5 L)	5.3 gal (20 L)	5.3 gal (20 L)	5.3 gal (20 L)	5.3 gal (20 L)
Safety cans	2.6 gal (10 L)	5.3 gal (20 L)	5.3 gal (20 L)	5.3 gal (20 L)	5.3 gal (20 L)
Metal drum (e.g., UN 1A1/1A2)	119 gal (450 L)	119 gal (450 L)	119 gal (450 L)	119 gal (450 L)	119 gal (450 L)
Approved metal portable tanks and IBCs	793 gal (3000 L)	793 gal (3000 L)	793 gal (3000 L)	793 gal (3000 L)	793 gal (3000 L)
Rigid plastic IBCs (UN 31H1 or 31H2) and composite IBCs with rigid inner receptacle (UN31HZ1)	NP	NP	NP	793 gal (3000 L)	793 gal (3000 L)
Composite IBCs with flexible inner receptacle (UN31HZ2) and DOT/UN-approved flexible IBCs	NP	NP	NP	NP	NP
Non-bulk Bag-in-Box	NP	NP	NP	NP	NP
Polyethylene UN1H1 and UN1H2, or as authorized by DOT exemption	1.3 gal (5 L)	5.3 gal (20 L)*	5.3 gal (20 L)*	119 gal (450 L)	119 gal (450 L)
Fiber drum NMFC or UFC Type 2A; Types 3A, 3B-H, or 3B-L; or Type 4A	NP	NP	NP	119 gal (450 L)	119 gal (450 L)

NP: Not permitted for the container categories so classified unless a fire protection system is provided that is developed in accordance with 16.3.6 and is approved for the specific container and protection against static electricity is provided.

\*See 9.4.3.1.



- (2) Metal storage cabinets constructed in the following manner shall be acceptable:
  - (a) The bottom, top, door, and sides of the cabinet shall be at least No. 18 gauge sheet steel and shall be double-walled, with 1½ in. (38 mm) air space.
  - (b) Joints shall be riveted, welded, or made tight by some equally effective means.
  - (c) The door shall be provided with a three-point latch arrangement, and the door sill shall be raised at least 2 in. (50 mm) above the bottom of the cabinet to retain spilled liquid within the cabinet.
- (3) Wooden cabinets constructed in the following manner shall be acceptable:
  - (a) The bottom, sides, and top shall be constructed of exterior grade plywood that is at least 1 in. (25 mm) thick and of a type that will not break down or delaminate under fire conditions.
  - (b) All joints shall be rabbetted and shall be fastened in two directions with wood screws.
  - (c) Where more than one door is used, there shall be a rabbetted overlap of not less than 1 in. (25 mm).
  - (d) Doors shall be equipped with a means of latching, and hinges shall be constructed and mounted in such a manner as to not lose their holding capacity when subjected to fire exposure.
  - (e) A raised sill or pan capable of containing a 2 in. (50 mm) depth of liquid shall be provided at the bottom of the cabinet to retain spilled liquid within the cabinet.
- (4) Listed storage cabinets that have been constructed and tested in accordance with 9.5.3(1) shall be acceptable.

**9.5.4\*** Storage cabinets shall not be required by this code to be ventilated for fire protection purposes.

**9.5.4.1** If a storage cabinet is not ventilated, the vent openings shall be sealed with the bungs supplied with the cabinet or with bungs specified by the cabinet manufacturer.

**9.5.4.2\*** If a storage cabinet is ventilated for any reason, the vent openings shall be ducted directly to a safe location outdoors or to a treatment device designed to control volatile organic compounds (VOCs) and ignitable vapors in such a manner that will not compromise the specified performance of the cabinet and in a manner that is acceptable to the authority having jurisdiction.

**9.5.5\*** Storage cabinets shall include the following marking:

FLAMMABLE  
KEEP FIRE AWAY

**9.5.5.1** The minimum letter height for FLAMMABLE (signal word) shall be 2.0 in. (50 mm) and the minimum letter height for KEEP FIRE AWAY (message) shall be 1.0 in. (25 mm).

**9.5.5.2** All letters shall be uppercase and in contrasting color to the background.

**9.5.5.3** The marking shall be located on the upper portion of the cabinet’s front door(s) or frame.

**9.5.5.4** Use of other languages, the international symbol for “flammable” (a flame in a triangle), the international symbol for “keep fire away” (a burning match in “no” circle) shall be permitted.

**9.6 Maximum Allowable Quantities (MAQs) per Control Area.**

**9.6.1 General Occupancy Limits.** The maximum allowable quantities (MAQs) of liquids allowed in each control area shall not exceed the amounts specified in Table 9.6.1.

*Exception: As modified by 9.6.2 and Chapters 10 through 14.*

**Table 9.6.1 MAQ of Flammable and Combustible Liquids per Control Area**

	Liquid Class(es)	Quantity		Notes
		gal	L	
Flammable liquids	IA	30	115	1, 2
	IB and IC	120	460	1, 2
	IA, IB, IC combined	120	460	1, 2, 3
Combustible liquids	II	120	460	1, 2
	IIIA	330	1,265	1, 2
	IIIB	13,200	50,600	1, 2, 4

Notes:

(1) Quantities are permitted to be increased 100 percent where stored in approved flammable liquids storage cabinets or in safety cans in accordance with the fire code. Where Note 2 also applies, the increase for both notes is permitted to be applied accumulatively.

(2) Quantities are permitted to be increased 100 percent in buildings equipped throughout with an automatic sprinkler system installed in accordance with NFPA 13, *Standard for the Installation of Sprinkler Systems*. Where Note 1 also applies, the increase for both notes is permitted to be applied accumulatively.

(3) Containing not more than the maximum allowable quantity per control area of Class IA, Class IB, or Class IC flammable liquids, individually.

(4) Quantities are not limited in a building equipped throughout with an automatic sprinkler system installed in accordance with NFPA 13, *Standard for the Installation of Sprinkler Systems*, and designed in accordance with the protection criteria contained in Chapter 16 of this code.

**9.6.2 Special Occupancy Limits.**

**9.6.2.1** For the following occupancies, the MAQs per control area shall not exceed the amounts specified in Table 9.6.2.1:

- (1) Assembly
- (2) Ambulatory health care
- (3) Business
- (4) Day care
- (5) Detention and correctional
- (6) Educational
- (7) Health care
- (8) Residential

**9.6.2.2** For the occupancies specified in 9.6.2.1, storage in excess of 10 gal (38 L) of Class I and Class II liquids combined or in excess of 60 gal (227 L) of Class IIIA liquids shall be permitted where stored in flammable liquids storage cabinets and where the total aggregate quantity does not exceed 180 gal (680 L).

**9.6.2.3** Fuel in the tanks of operating mobile equipment shall be permitted to exceed the quantities specified in Table 9.6.1, where the equipment is operated in accordance with the fire code.

**Table 9.6.2.1 MAQs — Special Occupancy Limits**

Liquid Class(es)	Quantity	
	gal	L
I and II	10	38
IIIA	60	227
IIIB	120	454

**9.6.2.4** For ambulatory health care, day care, educational, and health care occupancies, the MAQ for Class IIIB liquids shall be permitted to be increased 100 percent if the building is protected throughout with an automatic sprinkler system installed in accordance with NFPA 13, *Standard for the Installation of Sprinkler Systems*.

### 9.7 Control Areas.

**9.7.1** For the purpose of this code, a control area shall be a space within a building where quantities of liquids that do not exceed the maximum quantities allowed by Table 9.6.1 or Table 9.6.2.1 are stored.

**9.7.2** Control areas shall be separated from each other by fire barriers in accordance with Table 9.7.2. [5000:34.2.5.1.1]

**Table 9.7.2 Design and Number of Control Areas**

Floor Level	Maximum Allowable Quantity per Control Area (percent)*	Number of Control Areas per Floor	Fire Resistance Rating for Fire Barriers (hr)†
Above grade plane			
>9	5	1	2
7-9	5	2	2
4-6	12.5	2	2
3	50	2	1
2	75	3	1
1	100	4	1
Below grade plane			
1	75	3	1
2	50	2	1
Lower than 2	NA	NA	NA

NA: Not allowed.

\*Percentages represent the maximum allowable quantities per control area shown in Table 9.6.1, with all of the increases permitted in the footnotes of that table.

†Fire barriers are required to include floors and walls, as necessary, to provide a complete separation from other control areas.

[400: Table 5.2.2.1]

**9.7.3** Control areas located below grade that are considered basements, as defined in 3.3.4, shall not be utilized for the storage of Class I liquids.

### 9.8 Classification of Occupancies That Exceed the Maximum Allowable Quantities of Liquids per Control Area.

**9.8.1\* Occupancy Classifications.** Buildings and portions of buildings where liquids are stored shall be classified as Protec-

tion Level 2 or Protection Level 3, as established in this section, when the MAQs per control area are exceeded.

**9.8.1.1 Protection Level 2.** Buildings and portions thereof storing quantities of liquids that are considered as High-Hazard Level 2 liquids and that exceed the maximum allowable quantities per control area shall be classified as Protection Level 2 occupancies.

**9.8.1.2 Protection Level 3.** Buildings and portions thereof storing quantities of liquids that are considered as High-Hazard Level 3 liquids and that exceed the maximum allowable quantities per control area shall be classified as Protection Level 3 occupancies.

**9.8.2\* Requirements for Specific Occupancies.** Liquids stored in Protection Level 2 or Protection Level 3 occupancies shall meet the applicable requirements for storage in a liquid storage room or liquid warehouse as defined in this code and in NFPA 5000, *Building Construction and Safety Code*.

### 9.9 Construction Requirements.

**9.9.1** Storage areas shall be constructed to meet the fire resistance ratings specified in Table 9.9.1. Construction assemblies shall comply with the test specifications given in ASTM E 119, *Standard Test Methods for Fire Tests of Building Construction and Materials*.

**Table 9.9.1 Fire Resistance Ratings for Liquid Storage Areas**

Type of Storage Area	Fire Resistance Rating (hr)		
	Interior Walls <sup>a</sup> , Ceilings, Intermediate Floors	Roofs	Exterior Walls
Liquid storage room			
Floor area ≤ 150 ft <sup>2</sup>	1	—	—
Floor area > 150 ft <sup>2</sup> , but ≤ 500 ft <sup>2</sup>	2	—	—
Liquid warehouse <sup>b,c,g</sup>	4 <sup>d</sup>	—	2 <sup>e</sup> , 4 <sup>f</sup>

For SI units, 1 ft<sup>2</sup> = 0.09 m<sup>2</sup>.

<sup>a</sup>Between liquid storage areas and any adjacent areas not dedicated to liquid storage.

<sup>b</sup>Fire resistance ratings for liquid warehouses storing only Class IIIB liquids, which are not heated above their flash point, are permitted to be reduced to 2 hours.

<sup>c</sup>Fire resistance ratings for liquid warehouses protected in accordance with Chapter 16 are permitted to be reduced to 2 hours.

<sup>d</sup>This shall be a fire wall as defined in NFPA 221, *Standard for High Challenge Fire Walls, Fire Walls, and Fire Barrier Walls*.

<sup>e</sup>For exposing walls that are located more than 10 ft (3 m) but less than 50 ft (15 m) from an important building or line of adjoining property that can be built upon.

<sup>f</sup>For exposing walls that are located 10 ft (3 m) or less from an important building or line of adjoining property that can be built upon.

<sup>g</sup>For accessory use areas in protected liquid warehouses, such as offices and restrooms, whose combined area is less than 10 percent of the area of the warehouse, no fire resistance rating shall be required for the interior walls and ceilings.

**9.9.2** Openings in interior walls to adjacent rooms or buildings and openings in exterior walls with fire resistance ratings shall be provided with normally closed, listed fire doors with

fire protection ratings that correspond to the fire resistance rating of the wall as specified in Table 9.9.2.

**Table 9.9.2 Protection Ratings for Fire Doors**

Fire Resistance Rating of Wall as Required by Table 9.9.1 (hr)	Fire Protection Rating of Door (hr)
1	¾
2	1½
4	3*

\*One fire door required on each side of interior openings for attached liquid warehouses.

**9.9.2.1** Such doors shall be permitted to be arranged to stay open during material-handling operations if the doors are designed to close automatically in a fire emergency by provision of listed closure devices.

**9.9.2.2** Fire doors shall be installed in accordance with NFPA 80, *Standard for Fire Doors and Other Opening Protectives*.

**9.9.3** Exterior walls shall be constructed to provide ready access for fire-fighting operations by means of access openings, windows, or lightweight, noncombustible wall panels.

*Exception: This requirement does not apply to liquid storage rooms totally enclosed within a building.*

## 9.10 Fire Protection.

**9.10.1 Protected Storage.** Fire protection requirements for protected storage shall meet the requirements of 9.10.2 and Chapter 16.

### 9.10.2 Manual Fire Protection.

**9.10.2.1** Portable fire extinguishers shall be provided in accordance with NFPA 10, *Standard for Portable Fire Extinguishers*, and this code.

**9.10.2.2** Portable fire extinguishers shall meet the following requirements:

- (1) At least one portable fire extinguisher having a capability of not less than 40:B shall be located outside of, but not more than 10 ft (3 m) from, the door opening into a liquid storage area.
- (2) At least one portable fire extinguisher having a capability of not less than 40:B shall be located within 30 ft (9 m) of any Class I or Class II liquids located outside of a liquid storage area or at least one portable fire extinguisher having a capacity of 80:B located within 50 ft (15 m) of such a storage area.

**9.10.2.3** Where provided, hose connections supplied from sprinkler systems shall be installed in accordance with NFPA 13, *Standard for the Installation of Sprinkler Systems*.

**9.10.2.4** Where provided, hose connections supplied by a standpipe system shall be installed in accordance with NFPA 14, *Standard for the Installation of Standpipe and Hose Systems*.

**9.10.2.5** Where provided, hose connections shall also meet the following requirements:

- (1) Hose connections shall be provided in protected general-purpose warehouses and in protected liquid warehouses.
- (2) Where preconnected hose is provided, it shall be either 1½ in. (38 mm) lined fire hose or 1 in. (25 mm) hard rubber hose, using combination spray and straight stream nozzles.

**9.10.2.6** Where hose connections are provided, the water supply shall be sufficient to meet the fixed fire protection demand plus a total of at least 500 gpm (1900 L/min) for inside and outside hose connections for at least 2 hours, unless otherwise specified in Chapter 16.

## 9.11 Emergency Control Systems. (Reserved)

## 9.12 Electrical Systems.

**9.12.1** Electrical area classification shall not be required for liquid storage areas where all containers, intermediate bulk containers, and portable tanks are sealed and are not opened, except as provided for in 9.12.2.

**9.12.2** For liquid storage rooms that are totally enclosed within the building, electrical wiring and utilization equipment for Class I liquid storage shall be Class I, Division 2 (Zone 2), and electrical wiring and utilization equipment in inside rooms used for the storage of Class II and Class III liquids shall be suitable for ordinary purpose.

*Exception: Class I, Division 2 (Zone 2) requirements apply to Class II and Class III liquids when stored at temperatures above their flash points.*

## 9.13\* Containment, Drainage, and Spill Control.

**9.13.1** Storage areas shall be designed and operated to prevent the discharge of liquids to public waterways, public sewers, or adjoining property, unless such discharge has been specifically approved.

**9.13.1.1** Where the drainage system discharges to private or public sewers or waterways, the drainage system shall be equipped with traps and separators.

**9.13.2** Where individual containers exceed 10 gal (38 L), curbs, scuppers, drains, or other suitable means shall be provided to prevent flow of liquids under emergency conditions into adjacent building areas.

**9.13.3** Containment or drainage to an approved location shall be provided.

**9.13.3.1** Where a drainage system is used, it shall also have sufficient capacity to carry the expected discharge of water from fire protection systems.

**9.13.4** Where only Class IIIB liquids are stored, spill control, containment, and drainage shall not be required.

**9.13.5** Where only unsaturated polyester resins (UPRs) containing not more than 50 percent by weight of Class IC, Class II, or Class IIIA liquid constituents are stored and are protected in accordance with 16.5.2.11, spill control, containment, and drainage shall not be required.

**9.13.6** Where storage is protected in accordance with Chapter 16, spill control, containment, and drainage shall also meet the requirements of Section 16.8.

**9.14 Ventilation.** Liquid storage areas where dispensing is conducted shall be provided with ventilation that meets the requirements of Section 18.6.



**9.15 Exhausted Enclosures. (Reserved)****9.16 Explosion Control.**

**9.16.1\*** Where Class IA liquids are stored in containers larger than 1 gal (4 L), areas shall be provided with a means of explosion control that meets the requirements of NFPA 69, *Standard on Explosion Prevention Systems*. An approved engineered damage limiting construction design shall also be permitted.

*Exception: This does not apply to a liquid storage room totally enclosed within a building.*

**9.16.2\*** Where unstable liquids are stored, an approved engineered construction method that is designed to limit damage from a deflagration or detonation, depending on the liquid stored, shall be used.

**9.17 Separation from Incompatible Materials.**

**9.17.1** Except as provided for in 9.17.3, liquids shall be separated from incompatible materials where the stored materials are in containers having a capacity of more than 5 lb (2.268 kg) or ½ gal (1.89 L).

**9.17.1.1** Separation shall be accomplished by one of the following methods:

- (1) Segregating incompatible materials storage by a distance of not less than 20 ft (6.1 m)
- (2) Isolating incompatible materials storage by a noncombustible partition extending not less than 18 in. (460 mm) above and to the sides of the stored materials
- (3) Storing liquid materials in flammable liquids storage cabinets in accordance with Section 9.5

**9.17.2** Liquids shall be separated from Level 2 and Level 3 aerosols in accordance with NFPA 30B, *Code for the Manufacture and Storage of Aerosol Products*.

**9.17.3** Flammable and combustible liquids shall be separated from oxidizers by at least 25 ft (7.6 m).

**9.17.4** Materials that are water-reactive, as described in NFPA 704, *Standard System for the Identification of the Hazards of Materials for Emergency Response*, shall not be stored in the same control area with liquids.

**9.18 Dispensing, Handling, and Use of Liquids in Storage Areas.**

**9.18.1** Dispensing, handling, and use of liquids shall meet all applicable requirements of Chapter 18.

**9.18.2** Dispensing of Class I liquids or Class II and Class III liquids at temperatures at or above their flash points shall not be permitted in storage areas that exceed 1000 ft<sup>2</sup> (93 m<sup>2</sup>) in floor area unless the dispensing area is separated from the storage areas in accordance with Table 9.9.1 and meets all other requirements of Section 9.9.

**9.19 Outdoor Storage of Liquids.** Storage of liquids outside of buildings shall meet the requirements of Chapter 14 or Chapter 15, whichever is applicable.

## Chapter 10 Storage of Liquids in Containers — Mercantile Occupancies

**10.1 Scope.**

**10.1.1** This chapter shall apply to mercantile occupancies that handle, store, and display liquids in containers that do not exceed 119 gal (450 L) individual capacity.

**10.1.2** This chapter shall also apply to limited dispensing of liquids incidental to mercantile operations.

**10.1.3** This chapter shall not apply to the following:

- (1) Containers, intermediate bulk containers, and portable tanks that are used in operations, as covered by Chapter 17
- (2) Liquids in the fuel tanks of motor vehicles, aircraft, boats, or portable or stationary engines
- (3) Beverages where packaged in individual containers that do not exceed 1.3 gal (5 L) capacity
- (4) Medicines, foodstuffs, cosmetics, and other consumer products that contain not more than 50 percent by volume of water-miscible flammable or combustible liquids, with the remainder of the product consisting of components that do not burn and where packaged in individual containers that do not exceed 1.3 gal (5 L) capacity
- (5) Liquids that have no fire point when tested in accordance with ASTM D 92, *Standard Test Method for Flash and Fire Points by Cleveland Open Cup Tester*, up to the boiling point of the liquid or up to a temperature at which the liquid shows an obvious physical change
- (6) Liquids with a flash point greater than 95°F (35°C) in a water-miscible solution or in dispersion with a water and noncombustible solids content of more than 80 percent by weight, and which do not sustain combustion when tested in accordance with “Method of Testing for Sustained Combustibility,” Title 49 Code of Federal Regulations, Part 173, Appendix H, or the UN publication *Recommendations on the Transport of Dangerous Goods*
- (7) Distilled spirits and wines in wooden barrels or casks

**10.2 Definitions Specific to Chapter 10. (Reserved)****10.3 General Requirements.**

**10.3.1** For the purposes of this chapter, unstable liquids shall be treated as Class IA liquids.

**10.3.2** Maximum allowable quantities of liquids for display and storage shall comply with Table 10.7.1, based on the level of protection provided.

**10.3.3** The design, construction, and capacity of containers shall comply with the applicable provisions of Section 9.4.

**10.3.4** Commonly accepted packagings for medicines, beverages, foodstuffs, cosmetics, and other common consumer products shall be exempt from the requirements of 9.4.1 and 9.4.3.

**10.3.5** Where utilized within a mercantile occupancy, the design, construction, and capacity of storage cabinets shall comply with the applicable provisions of Section 9.5.

**10.3.6\*** Where utilized within a mercantile occupancy, the design, construction, and operation of a separate liquid storage room or a hazardous material storage locker used as a separate inside liquid storage area shall comply with the applicable provisions of Chapter 9.

**10.4 Reserved.****10.5 Reserved.****10.6 Reserved.****10.7 Control Areas.**

**10.7.1** The maximum allowable quantities of liquids in each control area and in display and storage arrangements shall meet the requirements of this subsection and shall be as set forth in Table 10.7.1.

**Table 10.7.1 MAQs for Storage and Display in Mercantile Occupancies**

Level of Protection	Storage Limits	Liquid Classification		
		IA <sup>a</sup>	IB, IC, II, and IIIA — Any Combination	IIIB
Unprotected <sup>b</sup>	MAQ <sup>c</sup>	60 gal	3750 gal per control area; a maximum of two control areas permitted per occupancy when separation is provided by a minimum 1-hour-rated fire separation wall	15,000 gal
	Maximum storage density		2 gal/ft <sup>2</sup> in storage and display areas and adjacent aisles	
NFPA 13, ordinary hazard (group 2) sprinkler system <sup>b</sup>	MAQ <sup>c</sup>	120 gal	7500 gal per control area; a maximum of two control areas permitted per occupancy when separation is provided by a minimum 1-hour-rated fire separation wall	Unlimited
	Maximum storage density		4 gal/ft <sup>2</sup> in storage and display areas and adjacent aisles	
NFPA 30, Chapter 16	MAQ <sup>c</sup>	120 gal	30,000 gal per occupancy	Unlimited

For SI units, 1 gal = 3.8 L; 1 ft<sup>2</sup> = 0.09 m<sup>2</sup>.

<sup>a</sup>Ground-level floor only.

<sup>b</sup>For storage heights that do not exceed 12 ft (3.6 m).

<sup>c</sup>Does not include liquids exempted by 10.1.3.

**10.7.2** Existing unprotected mercantile occupancies in place prior to January 1, 1997, shall be permitted to store or display up to 7500 gal (28,400 L) of Class IB, IC, II, and IIIA liquids (any combination) in each control area.

### 10.8 Specific Restrictions.

**10.8.1** On floors above the ground level, storage or display of Class I and Class II liquids shall be limited to 60 gal (230 L) in unprotected occupancies and 120 gal (454 L) in protected occupancies.

**10.8.2** Class I and Class II liquids shall not be stored, displayed, or dispensed in basements.

**10.8.3** Liquids in containers of greater than 6 gal (23 L) capacity shall not be stored or displayed in areas normally accessible to the public.

**10.8.4** The total aggregate quantity of Class I and Class II liquids that are not water-miscible and are packaged in plastic containers of 1 gal (3.8 L) capacity or greater shall be limited as follows:

- (1) A maximum total quantity of 30 gal (115 L) per display or storage array
- (2) A maximum total quantity of 60 gal (230 L) per display or storage array that is protected by an automatic sprinkler system having a design density of 0.60 gpm/ft<sup>2</sup> (24 mm/min/m<sup>2</sup>) over 2500 ft<sup>2</sup> (232 m<sup>2</sup>) and using high-temperature, K11.2 or larger quick-response sprinklers
- (3) A maximum total quantity of 60 gal (230 L) per display or storage array where stored in listed flammable liquids storage cabinets

**10.8.4.1** Adjacent displays or storage arrays shall be separated by a minimum distance of 50 ft (15 m).

### 10.9 Construction Requirements.

**10.9.1** Separation walls between control areas shall meet the requirements of Table 10.7.1.

**10.9.2** Where utilized within a mercantile occupancy, the construction of a separate liquid storage room or a hazardous material storage locker used as a separate inside liquid storage room shall comply with the applicable provisions of Chapter 9. (See A.10.3.6.)

### 10.10 Fire Protection.

**10.10.1** Where provided, automatic sprinkler systems shall be designed in accordance with Table 10.7.1.

**10.10.2** Protection systems for storage and display of liquids that are designed and developed based on full-scale tests performed at an approved test facility shall be considered an acceptable alternative to the protection criteria set forth in Chapter 16. Such alternative protection systems shall be approved by the authority having jurisdiction.

**10.10.3** Portable fire extinguishers shall be provided where liquids are stored.

**10.10.4** Hoseline connections shall be provided where required by NFPA 13, *Standard for the Installation of Sprinkler Systems*.

### 10.11 Emergency Control Systems. (Reserved)



## 10.12 Electrical Systems.

**10.12.1** Electrical wiring and utilization equipment shall meet the requirements of Chapter 7.

**10.12.2** Electrical area classification shall not be required for liquid storage areas where all containers, intermediate bulk containers, and portable tanks are sealed and are not opened, except as provided for in 9.12.2.

**10.12.3** Electrical area classification shall not be required for dispensing of quantities that do not exceed 16 oz (0.5 L) including, but not limited to, tinting of paints and coatings.

## 10.13 Containment, Drainage, and Spill Control.

**10.13.1** Where individual containers exceed 10 gal (38 L) and protection has been provided in accordance with Chapter 16, containment and drainage shall be provided, in accordance with Section 16.8. (See also Section 9.13.)

**10.13.2** Where utilized within a mercantile occupancy, spill containment for separate liquid storage rooms and for hazardous material storage lockers used as separate liquid storage rooms shall meet applicable requirements of Section 9.13. (See A.10.3.6.)

**10.14 Ventilation.** Liquid storage areas where dispensing is conducted shall be provided with either a gravity ventilation system or a continuous mechanical exhaust ventilation system that meets the requirements of Section 18.6. Mechanical ventilation shall be used if Class I liquids are dispensed within the room.

## 10.15 Exhausted Enclosures. (Reserved)

## 10.16 Explosion Control. (Reserved)

**10.17 Separation from Incompatible Materials.** The provisions of Section 9.17 shall apply.

**10.18 Dispensing, Handling, and Use of Liquids in Mercantile Occupancies.** Dispensing, handling, and use of liquids shall meet applicable requirements of Chapter 18.

*Exception: This requirement does not apply to dispensing of quantities that do not exceed 16 oz (0.5 L) including, but not limited to, tinting of paints and coatings.*

**10.19 Outdoor Storage of Liquids.** Storage outside of buildings at mercantile occupancies shall meet the requirements of Chapter 14 or Chapter 15, whichever is applicable.

## Chapter 11 Storage of Liquids in Containers — Industrial Occupancies

**11.1 Scope.** This chapter shall apply to the storage of flammable and combustible liquids in industrial occupancies in the following:

- (1) Containers that do not exceed 119 gal (450 L) individual capacity
- (2) Portable tanks that do not exceed 660 gal (2500 L) individual capacity
- (3) Intermediate bulk containers that do not exceed 793 gal (3000 L)

## 11.2 Definitions Specific to Chapter 11. (Reserved)

**11.3 General Requirements.** The storage of liquids shall comply with either Chapter 9 or Section 18.5 of this code.

## Chapter 12 Storage of Liquids in Containers — Storage Occupancies

**12.1 Scope.** This chapter shall apply to the storage of liquids in liquid storage rooms, liquid warehouses, and general purpose warehouses in the following:

- (1) Drums or other containers that do not exceed 119 gal (450 L) individual capacity
- (2) Portable tanks that do not exceed 660 gal (2500 L) individual capacity
- (3) Intermediate bulk containers that do not exceed 793 gal (3000 L) individual capacity

## 12.2 Definitions Specific to Chapter 12. (Reserved)

## 12.3 General Requirements.

**12.3.1** A general-purpose warehouse that stores liquids in quantities that exceed the maximum allowable quantities permitted in control areas by Table 9.6.1, but do not exceed the amounts permitted by Section 12.8 shall meet the requirements of Section 12.8.

**12.3.2** A general-purpose warehouse that stores liquids in quantities that exceed the amounts permitted by Section 12.8 shall meet the requirements for a liquid storage room or liquid warehouse, whichever is applicable.

**12.3.3** Facilities covered by this chapter shall meet the requirements of Section 9.3.

**12.3.4** For the purposes of this chapter, protected storage shall mean storage installed after January 1, 1997, that is protected in accordance with Chapter 16. All other storage shall be considered unprotected storage unless an alternate means of protection has been approved by the authority having jurisdiction. (See 16.3.5 and Section 16.9.)

**12.3.5** Protected and unprotected solid pile and palletized storage shall be provided with aisles that are arranged so that no container, portable tank, or intermediate bulk container is more than 20 ft (6 m) from an aisle.

**12.3.6** Protected solid pile and palletized storage and protected storage on racks shall be provided with minimum 6 ft (1.8 m) aisles between adjacent piles or adjacent rack sections, unless otherwise specified in Chapter 16.

**12.3.7** Unprotected solid pile and palletized storage shall be provided with minimum 4 ft (1.2 m) aisles between adjacent piles. Main aisles shall be a minimum of 8 ft (2.4 m) wide.

*Exception: For Class IIIB liquids stored in containers at temperatures below their flash points, the distance between piles is permitted to be reduced from 4 ft (1.2 m) to 2 ft (0.6 m) in proportion to commensurate reductions in the maximum storage height and maximum quantity per pile as given in Table 12.6.2.2.*

**12.3.8** Unprotected rack storage shall be provided with minimum 4 ft (1.2 m) aisles between adjacent rack sections and adjacent storage of liquids. Main aisles shall be a minimum of 8 ft (2.4 m) wide.

**12.3.9** Storage of empty or idle combustible pallets inside protected liquid storage areas shall comply with NFPA 13, *Standard for the Installation of Sprinkler Systems*.

**12.3.10** Storage of empty or idle combustible pallets inside unprotected liquid storage areas shall be limited to a maximum pile size of 2500 ft<sup>2</sup> (230 m<sup>2</sup>) and to a maximum storage height of 6 ft (1.8 m).

**12.3.11** Storage of empty or idle combustible pallets shall be separated from storage of liquids by minimum 8 ft (2.4 m) aisles.

**12.3.12** Limited quantities of combustible commodities, as defined in NFPA 13, *Standard for the Installation of Sprinkler Systems*, shall be permitted to be stored in liquid storage areas if the ordinary combustibles, other than those used for packaging the liquids, are separated from the liquids in storage by a minimum of 8 ft (2.4 m) horizontally, either by aisles or by open racks, and if protection is provided in accordance with Chapter 16.

**12.4** Reserved.

**12.5** Reserved.

**12.6 Maximum Allowable Quantities and Maximum Storage Heights.**

**12.6.1 Liquid Storage Rooms.**

**12.6.1.1** Storage of liquids in liquid storage rooms shall meet the requirements specified in Table 12.6.1.1.

**Table 12.6.1.1 Quantity Limitations for Liquid Storage Rooms**

Total Floor Area (ft <sup>2</sup> )	Automatic Fire Protection Provided?*	Total Allowable Quantity (gal/ft <sup>2</sup> of floor area)
≤150	No	2
	Yes	5
>150 and ≤500	No	4†
	Yes	10

For SI units, 1 ft<sup>2</sup> = 0.09 m<sup>2</sup>; 1 gal = 3.8 L.

\*The fire protection system can be automatic sprinklers, water spray, carbon dioxide, dry chemical, or other approved system. (See Chapter 16.)

†Total allowable quantities of Class IA and IB liquids cannot exceed the quantities permitted in Table 12.6.2.2 or those permitted by 12.6.2.3.

**12.6.1.2** Containers over 30 gal (115 L) capacity that contain Class I or Class II liquids shall not be stacked more than one container high unless protected in accordance with Chapter 16.

*Exception: This requirement does not apply to liquid storage rooms and hazardous materials storage lockers that are located in a liquid warehouse and are provided with equal or greater fire protection than is provided for the warehouse itself.*

**12.6.2 Liquid Warehouses.**

**12.6.2.1** The total quantity of liquid stored in a protected liquid warehouse shall not be limited.

**12.6.2.2** Except as provided for in Chapter 9 and Chapter 13, unprotected liquid warehouses shall be as specified in Table 12.6.2.2.

**12.6.2.3** Where two or more classes of liquids are stored in a single pile or rack section, the following shall apply:

(1) The maximum quantity per pile or rack section and the maximum storage height permitted shall be the smallest

of the individual maximum quantities per pile or rack section and maximum storage heights for the specific classes present, respectively.

- (2) The maximum quantity per pile or rack section shall be limited to the sum of the proportional amounts that each class of liquid present bears to the maximum quantity per pile or rack section allowed for its respective class.
- (3) The sum of the proportional amounts shall not exceed 100 percent.

**12.7 Control Areas.** Control areas shall be in accordance with Section 9.7.

**12.8 General-Purpose Warehouses.**

**12.8.1\*** Class IB and IC liquids in containers of 1.3 gal (5 L) or less capacity, Class II liquids in containers of 5.3 gal (20 L) or less capacity, Class IIIA liquids in containers of 60 gal (230 L) or less capacity, and Class IIIB liquids in containers, intermediate bulk containers, or portable tanks of 275 gal (1040 L) or less capacity shall be permitted to be stored in warehouses that handle combustible commodities, as defined in NFPA 13, *Standard for the Installation of Sprinkler Systems*, provided that the storage area for liquids is protected with automatic sprinklers in accordance with either of the following:

- (1) The applicable provisions of NFPA 13 for 20 ft (6 m) high storage of Class IV commodities based on the storage configuration of the liquids
- (2) The provisions of Chapter 16

**12.8.2** The quantities and height of liquid storage are limited to the following:

- (1) Class IA liquids: not permitted
- (2) Class IB and IC liquids: 660 gal (2500 L), maximum 5 ft (1.5 m) high pile stored on floor, with no rack or other storage above
- (3) Class II liquid: 1375 gal (5200 L), maximum 5 ft (1.5 m) high pile stored on floor, with no rack or other storage above
- (4) Class IIIA liquid: 2750 gal (10,400 L), maximum 10 ft (3 m) high pile stored on floor, with no rack or other storage above or in storage racks to a maximum height of 10 ft (3 m)
- (5) Class IIIB liquid: 13,750 gal (52,000 L), maximum 15 ft (4.6 m) high pile stored on floor, with no rack or other storage above or in storage racks to a maximum height of 15 ft (4.6 m)

**12.8.3** Where two or more classes of liquids are stored in a single pile or rack section, the following shall apply:

- (1) The maximum total quantity and maximum storage height permitted shall be the smallest of the individual maximum total quantities and maximum storage heights for the specific classes present, respectively.
- (2) The maximum total quantity permitted shall be limited to the sum of the proportional amounts that each class of liquid present bears to the maximum total quantity permitted for its respective class.
- (3) The sum of the proportional amounts shall not exceed 100 percent.

**12.8.4\* Liquids in Plastic Containers.** Class I and Class II liquids in plastic containers shall not be stored in a general-purpose warehouse but shall be stored in a liquid storage room or liquid storage warehouse that meets the requirements of this chapter.



Table 12.6.2.2 Quantity Limitations for Unprotected Liquid Warehouses

Liquid Class	Containers			Metal Portable Tanks and Metal IBCs			Rigid Nonmetallic IBCs and Composite IBCs		
	Maximum Storage Height (ft)	Maximum Total Quantity per Pile or Rack Section (gal)	Maximum Total Quantity (gal)	Maximum Storage Height (ft)	Maximum Total Quantity per Pile or Rack Section (gal)	Maximum Total Quantity (gal)	Maximum Storage Height (ft)	Maximum Total Quantity per Pile or Rack Section (gal)	Maximum Total Quantity (gal)
IA	5	660	660	NP	NP	NP	NP	NP	NP
IB	5	1,375	1,375	7	2,000	2,000	NP	NP	NP
IC	5	2,750	2,750	7	4,000	4,000	NP	NP	NP
II	10	4,125	8,250	7	5,500	11,000	7	4,125	8,250
IIIA	15	13,750	27,500	7	22,000	44,000	7	13,750	27,500
IIIB	15	13,750	55,000	7	22,000	88,000	7	13,750	55,000

For SI units, 1 ft = 0.3 m; 1 gal = 3.8 L.

NP: Not permitted.

*Exception No. 1: The following liquids, packaged in plastic containers, are permitted to be stored in general-purpose warehouses in accordance with the protection and storage limitations specified in Section 12.8 as follows:*

- (1) Products containing not more than 50 percent by volume of water-miscible liquids, with the remainder of the product consisting of components that do not burn and where packaged in individual containers
- (2) Products containing more than 50 percent water-miscible liquids in individual containers not exceeding 16 oz (0.5 L) capacity in cartons

*Exception No. 2: Class I and Class II liquids in plastic containers are permitted to be stored in a general-purpose warehouse if the packaging systems are listed and labeled for use with these commodities. All other provisions of Section 12.8 also apply.*

**12.8.5** The following shall apply to the storage of liquids and ordinary combustible commodities in general purpose warehouses:

- (1) Liquids shall not be stored in the same pile or in the same rack sections as ordinary combustible commodities. Where liquids are packaged together with ordinary combustibles, as in kits, the storage shall be considered on the basis of whichever commodity predominates.
- (2) Except as provided for in 12.8.5(1), ordinary combustible commodities shall be separated from liquids in containers by a minimum distance of 8 ft (2.4 m).

**12.9 Construction Requirements.** Storage areas shall be constructed in accordance with Section 9.9.

**12.10 Fire Protection.** Fire protection for protected storage shall be in accordance with Chapter 16.

**12.11 Emergency Control Systems. (Reserved)**

**12.12 Electrical Systems.** Installation of electrical wiring and utilization equipment shall meet the requirements of Chapter 7 and Section 9.12.

**12.13 Containment, Drainage, and Spill Control.** Where individual containers exceed 10 gal (38 L), spill control shall be in accordance with Section 9.13.

**12.14 Ventilation.** Liquid storage areas where dispensing is conducted shall be provided with ventilation that meets the requirements of Section 18.6.

**12.15 Exhausted Enclosures. (Reserved)**

**12.16 Explosion Control.** Where required by Section 9.16, explosion control shall be provided and shall meet the requirements of that section.

**12.17 Separation from Incompatible Materials.** The provisions of Section 9.17 shall apply.

**12.18 Dispensing, Handling, and Use of Liquids in Storage Occupancies.** Dispensing, handling, and use in storage areas shall be in accordance with Chapter 18.

**12.19 Outdoor Storage of Liquids.** Storage outside of buildings shall meet the requirements of Chapter 14 or Chapter 15, whichever is applicable.

## Chapter 13 Storage of Liquids in Containers — Detached, Unprotected Buildings

**13.1 Scope.** This chapter shall apply to the storage of liquids in detached, unprotected buildings, in the following:

- (1) Drums or other containers that do not exceed 119 gal (450 L) individual capacity
- (2) Portable tanks that do not exceed 660 gal (2500 L) individual capacity
- (3) Intermediate bulk containers that do not exceed 793 gal (3000 L)

**13.2 Definitions Specific to Chapter 13. (Reserved)**

**13.3 General Requirements.**

**13.3.1\*** The building shall have a horizontal separation of at least 200 ft (60 m) [100 ft (30 m) where protection for exposures is provided] from exposed business, industrial, mercantile, and storage occupancies on the same property as well as from any property line that is or can be built upon.



**13.3.2\*** The building shall have a horizontal separation of at least 1000 ft (300 m) [500 ft (150 m) where protection for exposures is provided] from exposed occupancies other than business, industrial, mercantile, and storage on the same property as well as from any property line that is or can be built upon.

**13.3.3** Means of egress from the building shall not exceed 75 ft (23 m).

**13.3.4** Rack storage shall be arranged with minimum 4 ft (1.2 m) wide aisles between adjacent rack sections and between liquid storage and any adjacent storage.

**13.3.5** Solid pile and palletized storage shall be arranged so that piles are separated from each other by at least 4 ft (1.2 m). Aisles shall be provided and arranged so that no container or portable tank is more than 20 ft (6 m) from an aisle.

*Exception: For Class IIIB liquids stored in containers at temperatures below their flash points, the distance between piles is permitted to be reduced from 4 ft (1.2 m) to 2 ft (0.6 m) in proportion to commensurate reductions in maximum quantity per pile and maximum storage height, as given in Table 12.6.2.2.*

**13.3.6** Limited quantities of combustible commodities, as defined in NFPA 13, *Standard for the Installation of Sprinkler Systems*, shall be permitted to be stored in liquid storage areas if the ordinary combustibles, other than those used for packaging the liquids, are separated from the liquids in storage by a minimum of 8 ft (2.4 m) horizontally either by aisles or by open racks.

**13.3.7** Storage of empty or idle combustible pallets shall be limited to a maximum pile size of 2500 ft<sup>2</sup> (230 m<sup>2</sup>) and to a maximum storage height of 6 ft (1.8 m).

**13.3.7.1** Pallet storage shall be separated from liquid storage by aisles that are at least 8 ft (2.4 m) wide.

**13.3.8** Containers, intermediate bulk containers, and portable tanks shall not be stored closer than 36 in. (915 mm) to the nearest beam, chord, girder, or other roof member.

**13.4 Reserved.**

**13.5 Reserved.**

**13.6 Maximum Allowable Quantities and Maximum Storage Heights.**

**13.6.1** The total quantity of liquids stored in a detached unprotected liquid storage building shall not be limited.

**13.6.2** Storage of liquids in piles or racks in a detached, unprotected liquid storage building shall not exceed the maximum storage height and maximum quantity per pile or rack section allowed by Table 12.6.2.2.

**13.6.3** Where two or more classes of liquids are stored in a single pile or rack section, the following shall apply:

- (1) The maximum quantity per pile or rack section and the maximum storage height permitted shall be the smallest of the individual maximum quantities per pile or rack section and maximum storage heights for the specific classes present, respectively.
- (2) The maximum quantity per pile or rack section shall be limited to the sum of the proportional amounts that each class of liquid present bears to the maximum quantity per pile or rack section allowed for its respective class.
- (3) The sum of the proportional amounts shall not exceed 100 percent.

**13.7 Control Areas. (Reserved)**

**13.8 Reserved.**

**13.9 Construction Requirements.**

**13.9.1** The building shall not exceed one story in height.

**13.9.2** The building shall not have basements, crawl spaces, or other accessible underfloor areas.

**13.10 Fire Protection.**

**13.10.1** Automatic fire protection systems shall not be required.

**13.10.2** Manual fire-fighting equipment needed for incipient-level fire protection shall be provided in accordance with 9.10.2.

**13.11 Emergency Control Systems. (Reserved)**

**13.12 Electrical Systems.** Installation of electrical wiring and utilization equipment shall meet the requirements of Chapter 7 and Section 9.12.

**13.13 Containment, Drainage, and Spill Control.**

**13.13.1** Where individual containers exceed 10 gal (38 L), spill control shall be provided in accordance with Section 9.13.

**13.13.2** Containment or drainage shall be provided in accordance with Section 9.13.

*Exception: Containment or drainage need not be provided for fire protection water if the building does not have a water-based fire protection system.*

**13.14 Ventilation.** Liquid storage areas where dispensing is conducted shall be provided with ventilation that meets the requirements of Section 18.6.

**13.15 Exhausted Enclosure. (Reserved)**

**13.16 Explosion Control.** Where required by Section 9.16, explosion control shall be provided and shall meet the requirements of that section.

**13.17 Separation from Incompatible Materials.** The provisions of Section 9.17 shall apply.

**13.18 Dispensing, Handling, and Use of Liquids in Detached, Unprotected Buildings.** Dispensing, handling, and use in storage areas shall be in accordance with Chapter 18.

**13.19 Outdoor Storage of Liquids.** Storage outside of buildings shall meet the requirements of Chapter 14 or Chapter 15, whichever is applicable.

## Chapter 14 Hazardous Materials Storage Lockers

**14.1\* Scope.** This chapter shall apply to the storage of liquids in movable, modular, prefabricated storage lockers, also known as hazardous materials storage lockers (hereinafter referred to as lockers), specifically designed and manufactured for storage of hazardous materials, in the following:

- (1) Containers that do not exceed 119 gal (450 L) individual capacity
- (2) Portable tanks that do not exceed 660 gal (2500 L) individual capacity
- (3) Intermediate bulk containers that do not exceed 793 gal (3000 L) individual capacity

**14.2 Definitions Specific to Chapter 14. (Reserved)**



**14.3 General Requirements.**

**14.3.1** Lockers that are used as liquid storage rooms shall meet the requirements of Chapters 9 and 12 and Sections 14.4 and 14.6.

**14.3.2** Lockers that are located outside shall meet the requirements of Sections 14.4 through 14.6.

**14.4 Design and Construction of Hazardous Materials Storage Lockers.**

**14.4.1** The design and construction of a locker shall meet all applicable local, state, and federal regulations and requirements and shall be subject to the approval of the authority having jurisdiction.

**14.4.2** Movable prefabricated structures that have been examined, listed, or labeled by an organization acceptable to the authority having jurisdiction for use as a hazardous materials storage facility shall be acceptable.

**14.4.3** Lockers shall not exceed 1500 ft<sup>2</sup> (140 m<sup>2</sup>) gross floor area.

**14.4.4** Vertical stacking of lockers shall not be permitted.

**14.4.5** Where electrical wiring and electrical utilization equipment are required, they shall comply with Chapter 7 and Section 9.12.

**14.4.6** Where dispensing or filling is permitted inside a locker, operations shall comply with the provisions of Chapter 18.

**14.4.7** Ventilation shall be provided in accordance with Section 18.6.

**14.4.8** Lockers shall include a spill containment system to prevent the flow of liquids from the structure under emergency conditions.

**14.4.8.1** The containment system shall have sufficient capacity to contain 10 percent of the volume of containers allowed in the locker or the volume of the largest container, whichever is greater.

**14.5 Designated Sites for Hazardous Materials Storage Lockers.**

**14.5.1** Lockers shall be located on a designated approved site on the property.

**14.5.2** The designated site shall be arranged to provide the minimum separation distances specified in Table 14.5.2 between individual lockers, from locker to property line that is or can be built upon, and from locker to nearest side of public ways or to important buildings on the same property.

**14.5.3** Once the designated site is approved, it shall not be changed without the approval of the authority having jurisdiction.

**14.5.4** More than one locker shall be permitted on a designated site, provided that the separation distance between individual lockers is maintained in accordance with Table 14.5.2.

**14.5.5** Where the approved designated storage site is accessible to the general public, it shall be protected from tampering or trespassing.

**14.6 Storage Requirements.**

**14.6.1** Containers of liquid in their original shipping packages shall be permitted to be stored either palletized or solid piled.

**14.6.2** Unpackaged containers shall be permitted to be stored on shelves or directly on the floor of the locker.

**Table 14.5.2 Designated Sites**

Area of Designated Site <sup>a</sup> (ft <sup>2</sup> )	Between Individual Lockers	Minimum Separation Distance (ft)	
		From Locker to Property Line That Is or Can Be Built Upon <sup>b</sup>	From Locker to Nearest Side of Public Ways or to Important Buildings on Same Property <sup>b,c</sup>
≤100	5	10	5
>100 and ≤500	5	20	10
>500 and ≤1500 <sup>d</sup>	5	30	20

For SI units, 1 ft = 0.3 m; 1 ft<sup>2</sup> = 0.09 m<sup>2</sup>.

Note: If the locker is provided with a fire resistance rating of not less than 4 hours and deflagration venting is not required in accordance with Section 9.16, all distances required by Table 14.5.2 are permitted to be waived.

<sup>a</sup>Site area limits are intended to differentiate the relative size and thus the number of lockers that are permitted in one designated site.

<sup>b</sup>Distances apply to properties that have protection for exposures, as defined. If there are exposures and such protection for exposures does not exist, the distances should be doubled.

<sup>c</sup>When the exposed building has an exterior wall, facing the designated site, that has a fire resistance rating of at least 2 hours and has no openings to above grade areas within 10 ft (3 m) horizontally and no openings to below grade areas within 50 ft (15 m) horizontally of the designated area, the distances can be reduced to half of those shown in the table, except they should never be less than 5 ft (1.5 m).

<sup>d</sup>When a single locker has a gross single story floor area that will require a site area limit of greater than 1500 ft<sup>2</sup> (140 m<sup>2</sup>) or when multiple units exceed the area limit of 1500 ft<sup>2</sup> (140 m<sup>2</sup>), the authority having jurisdiction should be consulted for approval of distances.

**14.6.3** Containers over 30 gal (114 L) capacity storing Class I or Class II liquids shall not be stored more than two containers high.

**14.6.4** In all cases, the storage arrangement shall provide unrestricted access to and egress from the locker.

**14.6.5** Miscellaneous combustible materials, including but not limited to idle pallets, excessive vegetation, and packing materials, shall not be permitted within 5 ft (1.5 m) of the designated site approved for lockers.

**14.6.6** Warning signs for lockers shall be in accordance with applicable local, state, and federal regulations or with NFPA 704, *Standard System for the Identification of the Hazards of Materials for Emergency Response*.

**Chapter 15 Outdoor Storage**

**15.1 Scope.** This chapter shall apply to the storage of liquids outdoors in the following:

- (1) Drums or other containers that do not exceed 119 gal (450 L) individual capacity
- (2) Portable tanks that do not exceed 660 gal (2500 L) individual capacity
- (3) Intermediate bulk containers that do not exceed 793 gal (3000 L) individual capacity

## 15.2 Definitions Specific to Chapter 15. (Reserved)

**15.3 General Requirements.** Outdoor storage of liquids in containers, intermediate bulk containers, and portable tanks shall comply with Table 15.3 and with all applicable requirements of this chapter.

**15.3.1** Where two or more classes of liquids are stored in a single pile, the maximum quantity permitted in that pile shall be that of the most hazardous class of liquid present.

**15.3.2** No container, intermediate bulk container, or portable tank in a pile shall be more than 200 ft (60 m) from a minimum 20 ft (6 m) wide access way to permit approach of fire control apparatus under all weather conditions.

**15.3.3** The distances specified in Table 15.3 shall apply to properties that have protection for exposures as defined. If there are exposures and protection for exposures does not exist, the distance to the property line that is or can be built upon shall be doubled.

**15.3.4** Where total quantity stored does not exceed 50 percent of the maximum quantity per pile, as specified in Table 15.3, the distances to a property line that is or can be built upon and to streets, alleys, or public ways shall be permitted to be reduced by 50 percent but in no case to less than 3 ft (0.9 m).

**15.3.5** The storage area shall be graded in a manner to divert possible spills away from buildings or other exposures or shall be surrounded by a curb at least 6 in. (150 mm) high.

**15.3.5.1** Where curbs are used, provisions shall be made to drain accumulations of groundwater or rainwater or spills of liquids. Drains shall terminate at a safe location and shall flow freely under fire conditions.

**15.3.6** When accessible to the public, the storage area shall be protected against tampering and trespassing.

**15.3.7** The storage area shall be kept free of weeds, debris, and other combustible materials not necessary to the storage

for a distance of at least 10 ft (3 m) around the perimeter of the stored materials.

**15.3.8** The storage area shall be permitted to be protected from the weather by a canopy or roof that does not limit the dissipation of heat or dispersion of flammable vapors and does not restrict fire-fighting access and control.

## 15.4 Outdoor Storage Adjacent to a Building.

**15.4.1** A maximum of 1100 gal (4160 L) of liquids in containers, intermediate bulk containers, or portable tanks shall be permitted to be stored adjacent to a building under the same management, provided the following conditions apply:

- (1) The adjacent building wall has an exterior fire resistance rating of 2 hours.
- (2) The adjacent building wall has no openings at grade or above grade that are within 10 ft (3 m) horizontally of the storage.
- (3) The adjacent building wall has no openings directly above the storage.
- (4) The adjacent building wall has no openings below grade within 50 ft (15 m) horizontally of the storage.

**15.4.2** The provisions of 15.4.1(1) through 15.4.1(4) shall be permitted to be waived, subject to the approval of the authority having jurisdiction, if the building in question is one story, is of fire-resistive or noncombustible construction, and is devoted principally to the storage of liquids.

**15.4.3** The quantity of liquid stored adjacent to a building that meets the conditions of 15.4.1(1) through 15.4.1(4) shall be permitted to exceed that permitted in 15.4.1, provided the maximum quantity per pile does not exceed 1100 gal (4160 L) and each pile is separated by a 10 ft (3 m) minimum clear space along the common wall.

**Table 15.3 Storage Limitations for Outside Storage**

Liquid Class	Containers		Portable Tanks and Metal IBCs		Rigid Plastic and Composite IBCs		Minimum Separation Distance (ft)		
	Maximum Quantity per Pile (gal) <sup>a,b,c</sup>	Maximum Storage Height (ft)	Maximum Quantity per Pile (gal)	Maximum Storage Height (ft)	Maximum Quantity per Pile (gal) <sup>a,c</sup>	Maximum Storage Height (ft)	Between Piles or Rack Sections	To Property Line That Is or Can Be Built Upon <sup>b,d</sup>	To Street, Alley, or Public Way <sup>b</sup>
IA	1,100	10	2,200	7	NP	NP	5	50	10
IB	2,200	12	4,400	14	NP	NP	5	50	10
IC	4,400	12	8,800	14	NP	NP	5	50	10
II	8,800	12	17,600	14	8,800	14	5	25	5
III	22,000	18	44,000	14	22,000	18	5	10	5

For SI units, 1 ft = 0.3 m; 1 gal = 3.8 L.

NP: Not permitted.

<sup>a</sup>See 15.3.1 regarding mixed-class storage.

<sup>b</sup>See 15.3.4 for smaller pile sizes.

<sup>c</sup>For storage in racks, the quantity limits per pile do not apply, but the rack arrangements should be limited to a maximum of 50 ft (15 m) in length and two rows or 9 ft (2.7 m) in depth.

<sup>d</sup>See 15.3.3 regarding protection for exposures.



**15.4.4** The quantity of liquid stored shall be permitted to exceed the 1100 gal (4160 L) quantity specified by 15.4.1 where a minimum distance equal to that specified by Table 15.3 for distance to property line shall be maintained between buildings and the nearest container or portable tank.

**15.4.5** Where the provisions of 15.4.1 cannot be met, a minimum distance equal to that specified by Table 15.3 for distance to property line shall be maintained between buildings and the nearest container or portable tank.

## Chapter 16 Automatic Fire Protection for Inside Liquid Storage Areas

### 16.1 Scope.

**16.1.1\*** This chapter shall apply to automatic fire protection systems for all inside storage of flammable and combustible liquids in containers, intermediate bulk containers, and portable tanks as specified in Section 9.4.

**16.1.2\*** This chapter shall not apply to Class IA flammable liquids or to unstable flammable or combustible liquids.

**16.1.3** Storage of liquids that is protected in accordance with the applicable requirements of this chapter shall be considered protected, as defined in 16.2.2. All other storage shall be considered unprotected unless an alternate means of protection has been approved by the authority having jurisdiction.

**16.2 Definitions Specific to Chapter 16.** For the purposes of this chapter, the terms in this section shall have the definitions given.

**16.2.1 IBC.** Where used in this chapter, *IBC* refers to intermediate bulk containers.

**16.2.2 Protected Storage.** Flammable and combustible liquids storage that is protected in accordance with this chapter.

**16.2.3\* Relieving-Style Container.** A metal container, a metal intermediate bulk container, or a metal portable tank that is equipped with at least one pressure-relieving mechanism at its top that is designed, sized, and arranged to relieve the internal pressure generated due to exposure to fire so that violent rupture is prevented.

**16.2.4\* Unsaturated Polyester Resin (UPR).** A resin that contains up to 50 percent by weight of Class IC, Class II, or Class III liquid, but no Class IA or Class IB liquid.

**16.2.5 Viscous Liquid.** A liquid that gels, thickens, or solidifies when heated or whose viscosity at room temperature versus weight percent content of Class I, Class II, or Class III liquid is in the shaded portion of Figure 16.2.5.

**16.2.6 Water-Miscible Liquid.** A liquid that mixes in all proportions with water without the use of chemical additives, such as emulsifying agents.

### 16.3 General Requirements.

**16.3.1** Where different classes of liquids, container types, and storage configurations are stored in the same protected area, protection shall meet either of the following:

- (1) Requirements of this chapter for the most severe storage fire hazard present
- (2) Where areas are not physically separated by a barrier or partition capable of delaying heat from a fire in one haz-

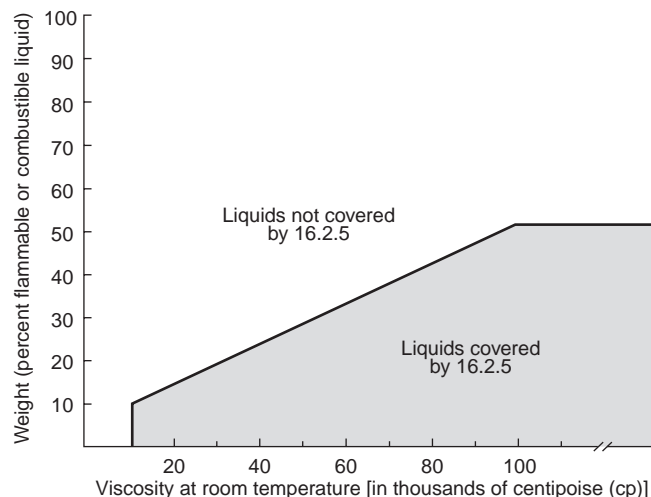

**FIGURE 16.2.5 Viscous Liquid: Viscosity Versus Weight Percent Flammable or Combustible Component.**

ard area from fusing sprinklers in an adjacent hazard area, the required protection for the more demanding hazard shall:

- (a) Extend 20 ft (6 m) beyond its perimeter, but not less than the required minimum sprinkler design area
- (b) Be provided with means to prevent the flow of burning liquid under emergency conditions into adjacent hazard areas
- (c) Provide containment and drainage as required by Section 16.8

**16.3.2** Unless otherwise specified in this chapter, single-row racks shall not be more than 4.5 ft (1.4 m) in depth and double-row racks shall not be more than 9 ft (2.8 m) in depth.

**16.3.3** When applying the fire protection criteria of this chapter, a minimum aisle space of 6 ft (1.8 m) shall be provided between adjacent piles or adjacent rack sections, unless otherwise specified in the tables in Section 16.5.

**16.3.4** Viscous liquids, as defined in 16.2.5, shall be permitted to be protected using one of the following:

- (1) For metal containers, the criteria for Class IIIB liquids, as determined by Figure 16.4.1(a)
- (2) For nonmetallic containers, the criteria for Class IIIB liquids, as determined by Figure 16.4.1(b)
- (3) For nonmetallic containers, the criteria for cartoned unexpanded Group A plastics in accordance with NFPA 13, *Standard for the Installation of Sprinkler Systems*, as indicated in Figure 16.4.1(b)

**16.3.5** Protection systems that are designed and developed based on full-scale fire tests performed at an approved test facility or on other engineered protection schemes shall be considered an acceptable alternative to the protection criteria set forth in this chapter. Such alternative protection systems shall be approved by the authority having jurisdiction.

**16.3.6** For relieving-style containers of greater than 6.6 gal (25 L) and up to 119 gal (450 L) capacity, the following shall apply:

- (1) The pressure-relieving mechanism shall be listed and labeled in accordance with FM Global *Approval Standard for Plastic Plugs for Steel Drums*, Class Number 6083, or equivalent.
- (2) The pressure-relieving mechanism shall not be painted, and cap seals, if used, shall be made of thermoplastic material.
- (3) For metal containers greater than 6.6 gal (25 L) capacity, the pressure-relieving mechanism shall be unobstructed or an additional pressure-relieving mechanism shall be provided.

**16.3.7** To be considered protected by Table 16.5.2.9 and Table 16.5.2.10, rigid nonmetallic intermediate bulk containers shall be subjected to a standard fire test that demonstrates acceptable inside storage fire performance and shall be listed and labeled.

#### 16.4 Automatic Sprinkler and Foam-Water Sprinkler Fire Protection Systems.

**16.4.1** Where automatic sprinkler systems or low-expansion foam-water sprinkler systems are used to protect storage of liquids, Figure 16.4.1(a), Figure 16.4.1(b), or Figure 16.4.1(c), whichever is applicable, and the appropriate table in Section 16.5 shall be used to determine protection criteria.

**16.4.1.1** Figure 16.4.1(a) shall be used for miscible and non-miscible flammable and combustible liquids in metal containers, metal portable tanks, and metal intermediate bulk containers.

**16.4.1.2** Figure 16.4.1(b) shall be used for miscible and non-miscible flammable and combustible liquids in nonmetallic containers and in nonmetallic intermediate bulk containers.

**16.4.1.3** Figure 16.4.1(c) shall be used for water-miscible flammable and combustible liquids in nonmetallic containers and in nonmetallic intermediate bulk containers.

**16.4.2** Automatic sprinkler and foam-water fire protection systems shall be wet pipe, deluge, or preaction systems.

**16.4.2.1** If a preaction system is used, it shall be designed so that water or foam solution will immediately discharge from the sprinkler upon sprinkler actuation.

**16.4.2.2** A foam-water sprinkler system that meets any of the design criteria specified in the water sprinkler tables in this section shall be acceptable, provided that the system is installed in accordance with NFPA 16, *Standard for the Installation of Foam-Water Sprinkler and Foam-Water Spray Systems*.

**16.4.3** Water-based fire protection systems shall be inspected, tested, and maintained in accordance with NFPA 25, *Standard for the Inspection, Testing, and Maintenance of Water-Based Fire Protection Systems*.

#### 16.5 Fire Protection System Design Criteria.

**16.5.1 General.** Paragraphs 16.5.2.1 through 16.5.2.12 and their related tables, Table 16.5.2.1 through Table 16.5.2.12, shall be used to determine the protection criteria and storage arrangement for the applicable liquid class, container type, and storage configuration, as described in 16.5.2.1 through 16.5.2.12 and subject to the provisions of 16.5.1.

**16.5.1.1** Table 16.5.2.1 through Table 16.5.2.12 shall apply only to stable liquids.

**16.5.1.1.1** The protection criteria in Table 16.5.2.1 through Table 16.5.2.12 shall only be used with ceilings having a pitch of 2 in 12 or less.

**16.5.1.2** When foam or foam-water fire protection systems are provided, discharge densities shall be determined based on the listing criteria of the foam discharge devices selected, the foam concentrate, the specific liquids to be protected, and the criteria in the appropriate table in this chapter. Where the discharge densities given in the tables differ from those in the listing criteria for the discharge devices, the greater of the two shall be used.

**16.5.1.3** In-rack sprinklers shall be installed in accordance with the provisions of NFPA 13, *Standard for the Installation of Sprinkler Systems*. In addition, the following modifications shall apply:

- (1) In-rack sprinklers shall be laid out in accordance with 16.5.1.10 and Section 16.6, as applicable.
- (2) Sprinklers in multiple-level in-rack sprinkler systems shall be provided with water shields unless they are separated by horizontal barriers or are specifically listed for installation without water shields.
- (3) A vertical clear space of at least 6 in. (150 mm) shall be maintained between the sprinkler deflector and the top tier of storage.
- (4) Sprinkler discharge shall not be obstructed by horizontal rack structural members.
- (5) Where in-rack sprinklers are installed below horizontal barriers, the deflector shall be located a maximum of 7 in. (180 mm) below the barrier.
- (6) Longitudinal and transverse flue spaces of at least 6 in. (150 mm) shall be maintained between each rack load.

**16.5.1.4** Ceiling sprinklers shall be installed in accordance with NFPA 13, *Standard for the Installation of Sprinkler Systems*, and shall be permitted to have the following maximum head spacing:

- (1) Classes I, II, and IIIA liquids: 100 ft<sup>2</sup> (9.3 m<sup>2</sup>) per sprinkler
- (2) Class IIIB liquids: 120 ft<sup>2</sup> (11.1 m<sup>2</sup>) per sprinkler

**16.5.1.4.1** Ordinary or intermediate temperature-rated K-25 extended-coverage sprinklers shall be permitted to be used as standard response high-temperature sprinklers at greater than 144 ft<sup>2</sup> (13 m<sup>2</sup>) coverage, with 12 ft (3.7 m) minimum spacing and a maximum coverage area of 196 ft<sup>2</sup> (18 m<sup>2</sup>) coverage.

**16.5.1.5** The ceiling heights given in Table 16.5.2.1 through Table 16.5.2.12, excluding Table 16.5.2.8, shall be permitted to be increased by a maximum of 10 percent if an equivalent percent increase in ceiling sprinkler design density is provided.

**16.5.1.6** Foam-water sprinkler systems shall be designed and installed in accordance with NFPA 16, *Standard for the Installation of Foam-Water Sprinkler and Foam-Water Spray Systems*.

**16.5.1.6.1** Foam-water sprinkler systems shall have at least 15 minutes of foam concentrate, based on the required design flow rate.

**16.5.1.6.2\*** Foam-water sprinkler systems shall provide foam solution at the minimum required concentration with as few as four sprinklers flowing.

**16.5.1.7** When relieving-style containers are used, both ¾ in. (20 mm) and 2 in. (50 mm) listed and labeled pressure-relieving mechanisms are required on containers greater than 6 gal (23 L) capacity.

**16.5.1.8** For the purposes of Section 16.5, a rigid nonmetallic intermediate bulk container is one that meets the maximum allowable capacity criteria of Table 9.4.3 and has been listed and labeled in accordance with UL 2368, *Standard for Fire Exposure Testing of Intermediate Bulk Containers for Flammable and Combustible Liquids*, or equivalent.



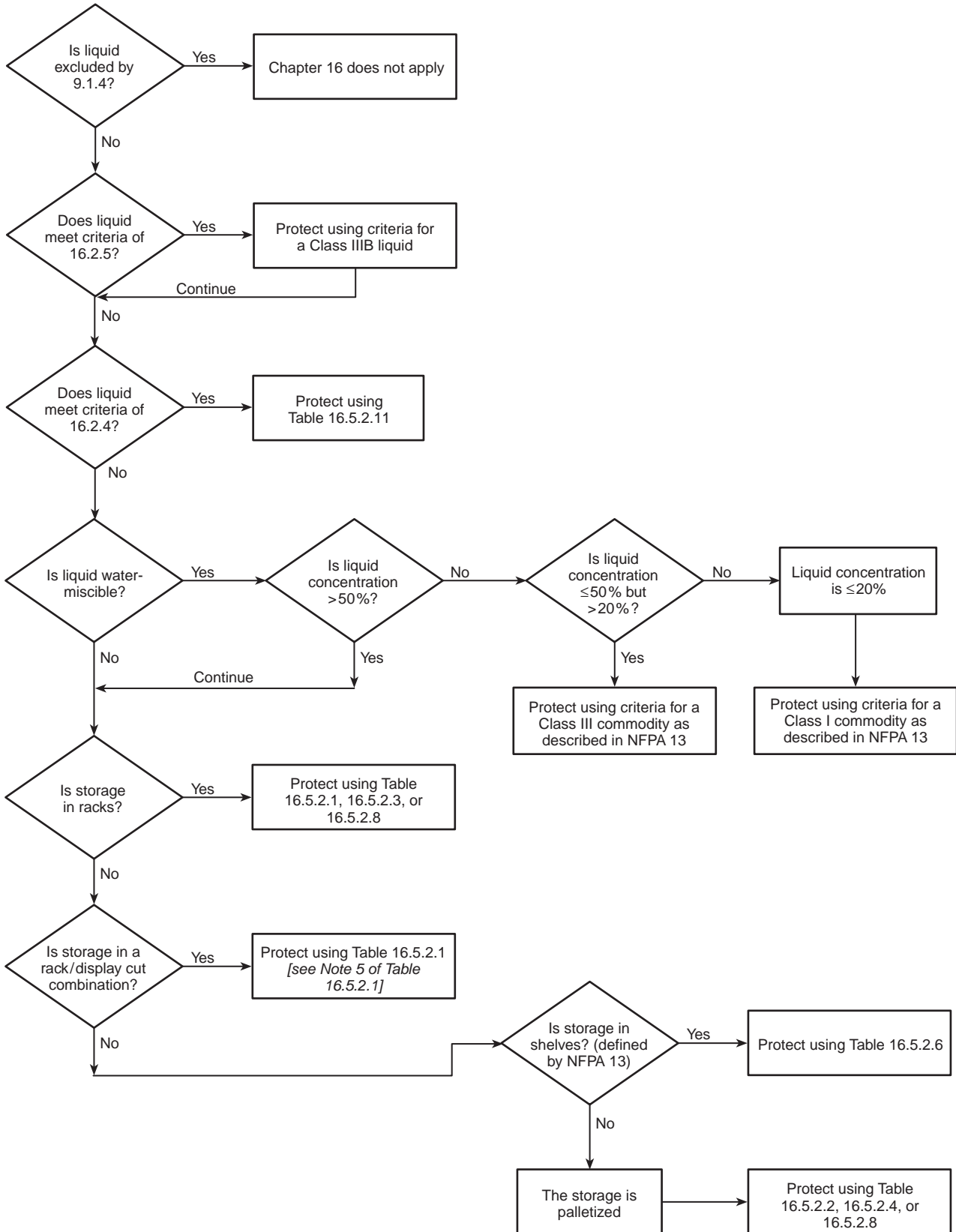
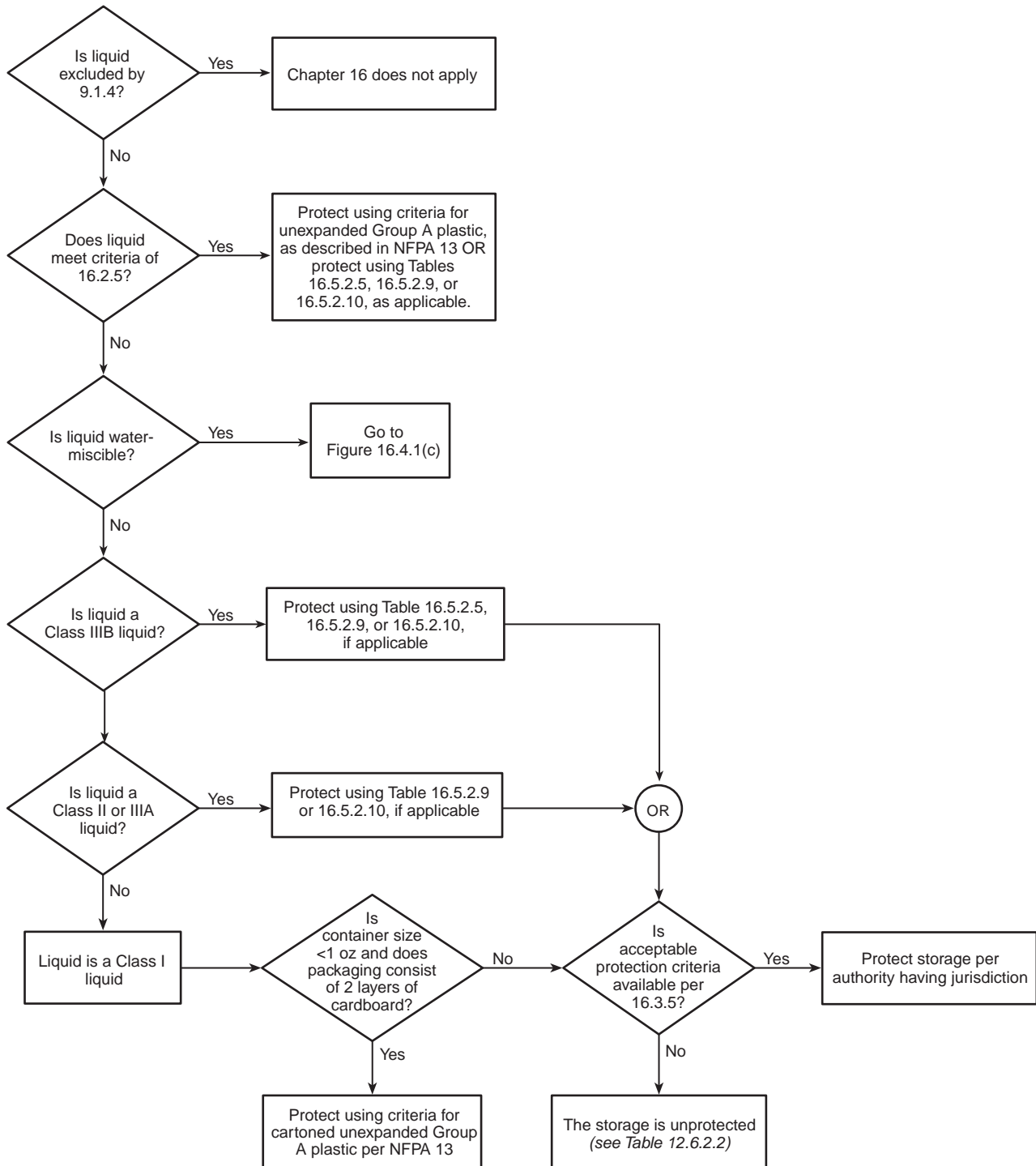
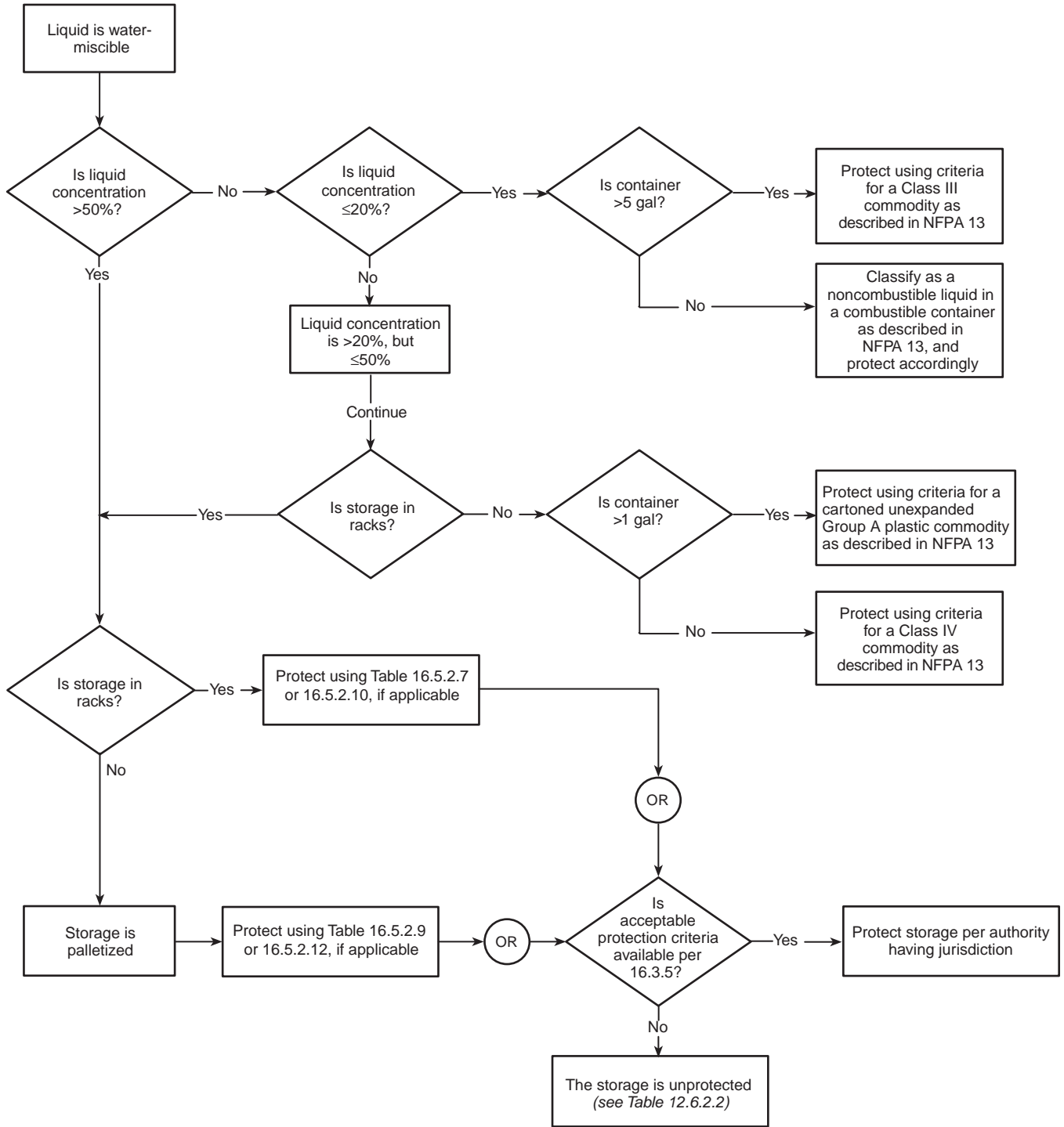

FIGURE 16.4.1(a) Fire Protection Criteria Decision Tree for Miscible and Nonmiscible Flammable and Combustible Liquids in Metal Containers.



**FIGURE 16.4.1(b) Fire Protection Criteria Decision Tree for Miscible and Nonmiscible Flammable and Combustible Liquids in Nonmetallic Containers.**



Note: For SI units, 1 gal = 3.8 L.

**FIGURE 16.4.1(c) Fire Protection Criteria Decision Tree for Miscible Flammable and Combustible Liquids in Nonmetallic Containers.**



**16.5.1.9** For the purposes of Section 16.5, the following shall apply:

- (1) 1 gal = 3.8 L; 1 ft = 0.3 m; 1 ft<sup>2</sup> = 0.09 m<sup>2</sup>
- (2) 1 gpm/ft<sup>2</sup> is equivalent to 40.7 L/min/m<sup>2</sup> or 40.7 mm/min
- (3) A gauge pressure of 1 psi is equivalent to a gauge pressure of 6.9 kPa
- (4) SR = standard response sprinkler; QR = quick response sprinkler; ESFR = early suppression fast-response sprinkler; OT = ordinary temperature; HT = high temperature
- (5) Where an ordinary-temperature sprinkler is indicated, an intermediate-temperature sprinkler shall be used where ambient conditions require.

**16.5.1.10** For the purposes of Section 16.5, the following shall apply to the in-rack sprinkler design layouts specified in Table 16.5.2.1 through Table 16.5.2.12:

- (1) Layout 1, as referenced in Table 16.5.2.1, shall mean one line of in-rack sprinklers 8 ft (2.4 m) above the floor in the longitudinal flue space, with sprinklers spaced not more than 10 ft (3 m) on center.
- (2) Layout 2, as referenced in Table 16.5.2.1, shall mean one line of in-rack sprinklers 6 ft (1.8 m) above the floor and one line of in-rack sprinklers 12 ft (3.6 m) above the floor in the longitudinal flue space, with sprinklers spaced not more than 10 ft (3 m) on center. Sprinklers shall be staggered vertically.
- (3) Layout 3, as referenced in Table 16.5.2.1 and Table 16.5.2.3, shall mean one line of in-rack sprinklers in the longitudinal flue space at every storage level above the floor except above the top tier, with sprinklers spaced not more than 10 ft (3 m) on center. Sprinklers shall be staggered vertically, where more than one level of in-rack sprinklers is installed.
- (4) Layout 4, as referenced in Table 16.5.2.1 and Table 16.5.2.3, shall mean one line of in-rack sprinklers in the longitudinal flue space at every other storage level, except above the top tier, beginning above the first storage level, with sprinklers spaced not more than 10 ft (3 m) on center. Sprinklers shall be staggered vertically, where more than one level of in-rack sprinklers is installed.
- (5) Layout 5, as referenced in Table 16.5.2.1, shall mean one line of in-rack sprinklers in the longitudinal flue space at every storage level above the floor except above the top tier and face sprinklers at the first storage level at each rack upright. In-rack sprinklers shall be spaced not more than 9 ft (2.7 m) on center and shall be staggered vertically, where more than one level of in-rack sprinklers is installed.
- (6) Layout 6, as referenced in Table 16.5.2.1, shall mean one line of in-rack sprinklers in the longitudinal flue space at every other storage level above the first storage level except the top tier and face sprinklers at the first storage level at each rack upright. In-rack sprinklers shall be spaced not more than 10 ft (3 m) on center and shall be staggered vertically, where more than one level of in-rack sprinklers is installed.
- (7) Layout 7, as referenced in Table 16.5.2.8, shall be as shown in Figure 16.6.4(a).
- (8) Layout 8, as referenced in Table 16.5.2.8, shall be as shown in Figure 16.6.4(b) or Figure 16.6.4(c).
- (9) Layout 9, as referenced in Table 16.5.2.8, shall be as shown in Figure 16.6.4(d) or Figure 16.6.4(e).

**16.5.1.11** The "Fire Test Ref." number given for each entry in Table 16.5.2.1 through Table 16.5.2.12 shall be used to iden-

tify in Section D.2 the information on the fire tests on which the protection criteria for that entry are based.

**16.5.1.12** The water supply shall be sufficient to meet the fixed fire protection demand plus a total of at least 500 gpm (1900 L/min) for inside and outside hose connections for at least 2 hours, unless otherwise specified in this chapter.

### 16.5.2 Specific Design Criteria.

**16.5.2.1** Table 16.5.2.1 shall apply to the following:

- (1) Automatic sprinkler protection
- (2) Single- or double-row rack storage
- (3) Nonmiscible liquids and miscible liquids with concentration of flammable or combustible component greater than 50 percent by volume
- (4) Metal containers, metal portable tanks, metal intermediate bulk containers
- (5) Relieving- or nonrelieving-style containers

**16.5.2.2** Table 16.5.2.2 shall apply to the following:

- (1) Automatic sprinkler protection
- (2) Palletized or stacked storage
- (3) Nonmiscible liquids and miscible liquids with concentration of flammable or combustible component greater than 50 percent by volume
- (4) Metal containers, metal portable tanks, metal intermediate bulk containers
- (5) Relieving- or nonrelieving-style containers

**16.5.2.3** Table 16.5.2.3 shall apply to the following:

- (1) Foam-water sprinkler protection
- (2) Single- or double-row rack storage
- (3) Nonmiscible liquids and miscible liquids with concentration of flammable or combustible component greater than 50 percent by volume
- (4) Metal containers, metal portable tanks, metal intermediate bulk containers
- (5) Relieving- or nonrelieving-style containers

**16.5.2.4** Table 16.5.2.4 shall apply to the following:

- (1) Foam-water sprinkler protection
- (2) Palletized or stacked storage
- (3) Nonmiscible liquids and miscible liquids with concentration of flammable or combustible component greater than 50 percent by volume
- (4) Metal containers, metal portable tanks, metal intermediate bulk containers
- (5) Relieving- or nonrelieving-style containers

**16.5.2.5** Table 16.5.2.5 shall apply to the following:

- (1) Automatic sprinkler protection
- (2) Single-, double-, or multiple-row rack storage
- (3) Class IIIB nonmiscible liquids and Class IIIB miscible liquids with concentration of flammable or combustible component greater than 50 percent by volume
- (4) Nonmetallic containers or intermediate bulk containers
- (5) Cartoned or uncartoned

**16.5.2.6** Table 16.5.2.6 shall apply to the following:

- (1) Automatic sprinkler protection
- (2) Shelf storage
- (3) Nonmiscible liquids and miscible liquids with concentration of flammable or combustible component greater than 50 percent by volume
- (4) Nonrelieving-style metal containers



**Table 16.5.2.1 Design Criteria for Sprinkler Protection of Single- and Double-Row Rack Storage of Liquids in Metal Containers, Portable Tanks, and IBCs**

Container Style and Capacity (gal)	Maximum Storage Height (ft)	Maximum Ceiling Height (ft)	Ceiling Sprinkler Protection				In-Rack Sprinkler Protection				Fire Test Ref. [See Table D.2(a)]	
			Sprinkler		Design		Sprinkler		Minimum Discharge Flow (gpm)	Layout (See 16.5.1.10)		Notes
			Type	Response	Density (gpm/ft <sup>2</sup> )	Area (ft <sup>2</sup> )	Type	Response				
<b>NONRELIEVING-STYLE CONTAINERS — LIQUID CLASSES IB, IC, II, IIIA</b>												
≤1	16	30	K≥11.2	QR (HT)	0.60	2000	K≥5.6	QR(OT)	30	1	1, 2, 7	1
	20	30	K≥11.2	SR or QR (HT)	0.60	2000	K≥5.6	QR(OT)	30	2	1, 2, 7	2
≤5	25	30	K≥8.0	SR or QR (HT)	0.30	3000	K≥5.6	QR(OT)	30	3	1, 7	3
>5 and ≤60	25	30	K≥11.2	SR (HT)	0.40	3000	K≥5.6	QR or SR(OT)	30	5	1, 7	5
<b>NONRELIEVING-STYLE CONTAINERS — LIQUID CLASS IIIB</b>												
≤5	40	50	K≥8.0	SR or QR (HT)	0.30	2000	K≥5.6	QR(OT)	30	4	1, 3, 7	4
>5 and ≤60	40	50	K≥8.0	SR (HT)	0.30	3000	K≥5.6	QR(OT)	30	4	1, 3, 7	6
<b>RELIEVING-STYLE CONTAINERS — LIQUID CLASSES IB, IC, II, IIIA</b>												
≤5	14	18	K≥11.2	QR (HT)	0.65	2000	No in-rack sprinklers required			4	7	
	25	30	K≥8.0	SR or QR (HT)	0.30	3000	K≥5.6	QR(OT)	30	4, 7	1, 5	8
>5 and ≤60	25	30	K≥11.2	SR (HT)	0.60	3000	K≥5.6	QR(OT)	30	6, 7	1	10
Portable tanks and IBCs	25	30	K≥11.2	SR (HT)	0.60	3000	K≥5.6	QR or SR(OT)	30	5, 7	1	12
<b>RELIEVING-STYLE CONTAINERS — LIQUID CLASS IIIB</b>												
≤ 5 gal	40	50	K≥8.0	SR or QR (HT)	0.30	2000	K≥5.6	QR(OT)	30	4, 7	1	9
>5 and ≤60	40	50	K≥8.0	SR (HT)	0.30	3000	K≥5.6	QR(OT)	30	4, 7	1, 3	11
Portable tanks and IBCs	40	50	K≥8.0	SR (HT)	0.30	3000	K≥5.6	QR(OT)	30	4, 7	1, 6	13

For SI units, 1 gal = 3.8 L, 1 ft = 0.3 m, 1 ft<sup>2</sup> = 0.09 m<sup>2</sup>, 1 gpm/ft<sup>2</sup> = 40.7 L/min/m<sup>2</sup> = 40.7 mm/min.  
 For definitions of abbreviations used in the Response column, see 16.5.1.9(4). See also 16.5.1.9(5).

Notes:

- (1) In-rack sprinkler design shall be based on the following:
  - (a) Where one level of in-rack sprinklers is installed, the design shall include the 8 most hydraulically remote sprinklers.
  - (b) Where two levels of in-rack sprinklers are installed, the design shall include the 6 most hydraulically remote sprinklers on each level.
  - (c) Where three or more levels of in-rack sprinklers are installed, the design shall include the 6 most hydraulically remote sprinklers on the top three levels.
- (2) Protection for uncartoned or case-cut nonsolid shelf display up to 6.5 ft (2 m) and storage above on pallets in racking and stored on shelf materials, including open wire mesh, or 2 in. × 6 in. (50 mm × 150 mm) wooden slats, spaced a minimum of 2 in. (50 mm) apart.
- (3) Increase ceiling density to 0.60 if more than one level of storage exists above the top level of in-rack sprinklers.
- (4) Double-row racks limited to maximum 6 ft (1.8 m) width.
- (5) For K=8.0 and larger ceiling sprinklers, increase ceiling density to 0.60 over 2000 ft<sup>2</sup> if more than one level of storage exists above the top level of in-rack sprinklers.
- (6) Reduce in-rack sprinkler spacing to maximum 9 ft (2.7 m) centers.
- (7) The minimum in-rack discharge pressure shall not be less than 10 psi.

**Table 16.5.2.2 Design Criteria for Sprinkler Protection of Palletized and Stacked Storage of Liquids in Metal Containers, Portable Tanks, and IBCs**

Container Style and Capacity (gal)	Maximum Storage Height (ft)	Maximum Ceiling Height (ft)	Ceiling Sprinkler Protection				Notes	Fire Test Ref. [See Table D.2(b)]
			Sprinkler		Design			
			Type	Response	Density (gpm/ft <sup>2</sup> )	Area (ft <sup>2</sup> )		
<b>NONRELIEVING-STYLE CONTAINERS — LIQUID CLASSES IB, IC, II, IIIA</b>								
≤5	4	18	K≥8.0	SR or QR (HT)	0.21	1500	1	1
	5	18	K≥8.0	SR or QR (HT)	0.30	3000	—	2
>5 and ≤60	6.5	30	K≥11.2	QR (HT)	0.45	3000	—	3
	5	18	K≥11.2	SR (HT)	0.40	3000	—	4
<b>NONRELIEVING-STYLE CONTAINERS — LIQUID CLASS IIIB</b>								
≤5	18	30	K≥8.0	SR or QR (HT)	0.25	3000	—	5
>5 and ≤60	10	20	K≥8.0	SR (HT)	0.25	3000	—	6
	18	30	K≥8.0	SR (HT)	0.35	3000	—	7
<b>RELIEVING-STYLE CONTAINERS — LIQUID CLASSES IB, IC, II, IIIA</b>								
≤5	12	30	K≥11.2 pendent only	QR (HT)	0.60	3000	2	8
>5 and ≤60	5	30	K≥11.2	SR (HT)	0.40	3000	—	9
	6.5	30	K≥11.2	SR (HT)	0.60	3000	3	10
Portable tanks and IBCs	1-high	30	K≥8.0	SR (HT)	0.30	3000	—	14
	2-high	30	K≥11.2	SR (HT)	0.60	3000	—	15
<b>RELIEVING-STYLE CONTAINERS — LIQUID CLASS IIIB</b>								
≤5	18	30	K≥8.0	SR or QR (HT)	0.25	3000	—	11
>5 and ≤60	10	20	K≥8.0	SR (HT)	0.25	3000	—	12
	18	30	K≥8.0	SR (HT)	0.35	3000	—	13
Portable tanks and IBCs	1-high	30	K≥8.0	SR (HT)	0.25	3000	—	16
	2-high	30	K≥11.2	SR (HT)	0.50	3000	—	17

For SI units, 1 gal = 3.8 L, 1 ft = 0.3 m, 1 ft<sup>2</sup> = 0.09 m<sup>2</sup>, 1 gpm/ft<sup>2</sup> = 40.7 L/min/m<sup>2</sup> = 40.7 mm/min.

For definitions of abbreviations used in the Response column, see 16.5.1.9(4). See also 16.5.1.9(5).

Notes:

- (1) Minimum hose stream demand can be reduced to 250 gpm for 2 hours.
- (2) Sprinklers must also be hydraulically calculated to provide a density of 0.80 gpm/ft<sup>2</sup> over 1000 ft<sup>2</sup>.
- (3) Drums must be placed on open slatted pallet, not nested, to allow pressure relief from drums on lower levels.



**Table 16.5.2.3 Design Criteria for Foam-Water Sprinkler Protection of Single- or Double-Row Rack Storage of Liquids in Metal Containers, Portable Tanks, and IBCs**

Container Style and Capacity (gal)	Maximum Storage Height (ft)	Maximum Ceiling Height (ft)	Ceiling Sprinkler Protection				In-Rack Sprinkler Protection				Fire Test Ref. [See Table D.2(c)]	
			Sprinkler		Design		Sprinkler		Minimum Discharge Flow (gpm)	Layout (See 16.5.1.10)		Notes
			Type	Response	Density (gpm/ft <sup>2</sup> )	Area (ft <sup>2</sup> )	Type	Response				
<b>NONRELIEVING-STYLE CONTAINERS — LIQUID CLASSES IB, IC, II, IIIA</b>												
≤5	25	30	K≥8.0	SR or QR (HT)	0.30	2000	K≥5.6	QR or SR (OT)	30	3	1, 2, 4, 5	1
>5 and ≤60	25	30	K≥8.0	SR (HT)	0.30	3000	K≥5.6	QR or SR (OT)	30	3	1, 3, 4, 5	2
<b>NONRELIEVING-STYLE CONTAINERS — LIQUID CLASS IIIB</b>												
≤60	40	50	K≥8.0	SR (HT)	0.30	2000	K≥5.6	QR or SR (OT)	30	4	1, 5	3
<b>RELIEVING-STYLE CONTAINERS — LIQUID CLASSES IB, IC, II, IIIA</b>												
≤5	25	30	K≥8.0	SR or QR (HT)	0.30	2000	K≥5.6	QR or SR (OT)	30	4	1, 2, 4, 5	4
>5 and ≤60, portable tanks and IBCs	25	30	K≥8.0	SR (HT)	0.30	3000	K≥5.6		30	4	1, 3, 4, 5	5
<b>RELIEVING-STYLE CONTAINERS — LIQUID CLASS IIIB</b>												
≤60	40	50	K≥8.0	SR (HT)	0.30	2000	K≥5.6	QR or SR (OT)	30	4	1, 5	6

For SI units, 1 gal = 3.8 L, 1 ft = 0.3 m, 1 ft<sup>2</sup> = 0.09 m<sup>2</sup>, 1 gpm/ft<sup>2</sup> = 40.7 L/min/m<sup>2</sup> = 40.7 mm/min.

For definitions of abbreviations used in the Response column, see 16.5.1.9(4). See also 16.5.1.9(5).

Notes:

(1) In-rack sprinkler design based on the 6 most hydraulically remote sprinklers in each of the upper three levels.

(2) Design area can be reduced to 1500 ft<sup>2</sup> when using a preprimed foam-water system installed in accordance with NFPA 16, *Standard for the Installation of Foam-Water Sprinkler and Foam-Water Spray Systems*, and maintained according to NFPA 25, *Standard for the Inspection, Testing, and Maintenance of Water-Based Fire Protection Systems*.

(3) Design area can be reduced to 2000 ft<sup>2</sup> when using a preprimed foam-water system installed in accordance with NFPA 16 and maintained according to NFPA 25.

(4) In-rack sprinkler hydraulic design can be reduced to three sprinklers operating per level, with three levels operating simultaneously, when using a preprimed foam-water sprinkler system designed in accordance with NFPA 16 and maintained in accordance with NFPA 25.

The minimum in-rack sprinkler discharge pressure shall not be less than a gauge pressure of 10 psi.

**Table 16.5.2.4 Design Criteria for Foam-Water Sprinkler Protection of Palletized and Stacked Storage of Liquids in Metal Containers, Portable Tanks, and IBCs**

Container Style and Capacity (gal)	Maximum Storage Height (ft)	Maximum Ceiling Height (ft)	Ceiling Sprinkler Protection				Notes	Fire Test Ref. [See Table D.2(d)]
			Sprinkler		Design			
			Type	Response	Density (gpm/ft <sup>2</sup> )	Area (ft <sup>2</sup> )		
<b>NONRELIEVING-STYLE CONTAINERS — LIQUID CLASSES IB, IC, II, IIIA</b>								
≤5, cartoned	11	30	K≥11.2	SR or QR (HT)	0.40	3000	1	1
≤5, uncartoned	12	30	K≥8.0	SR or QR (HT)	0.30	3000	1	2
>5 and ≤60	5 (1-high)	30	K≥8.0	SR (HT)	0.30	3000	1	3
<b>RELIEVING-STYLE CONTAINERS — LIQUID CLASSES IB, IC, II, IIIA</b>								
>5 and ≤60	6.5 (2-high)	30	K≥8.0	SR (HT)	0.30	3000	2, 3	4
	10 (3-high)	33	K≥11.2	SR (HT)	0.45	3000	2, 3	6
	13.75 (4-high)	33	K≥11.2	SR (HT)	0.60	3000	2, 3	7
Portable tanks and IBCs	1- or 2-high	30	K≥8.0	SR (HT)	0.30	3000		5

For SI units, 1 gal = 3.8 L, 1 ft = 0.3 m, 1 ft<sup>2</sup> = 0.09 m<sup>2</sup>, 1 gpm/ft<sup>2</sup> = 40.7 L/min/m<sup>2</sup> = 40.7 mm/min.

For definitions of abbreviations used in the Response column, see 16.5.1.9(4). See also 16.5.1.9(5).

Notes:

(1) Design area can be reduced to 2000 ft<sup>2</sup> when using a preprimed foam-water system installed in accordance with NFPA 16, *Standard for the Installation of Foam-Water Sprinkler and Foam-Water Spray Systems*, and maintained according to NFPA 26, *Standard for the Inspection, Testing, and Maintenance of Water-Based Fire Protection Systems*.

(2) Both ¾ in. (20 mm) and 2 in. (50 mm) listed pressure-relieving mechanisms are required on containers greater than 6 gal (23 L) capacity.

(3) Drums placed on open slatted pallet, not nested, to allow pressure relief from drums on lower levels.

**Table 16.5.2.5 Design Criteria for Sprinkler Protection of Single-, Double-, and Multiple-Row Rack Storage of Class IIIB Liquids**

Closed-Cup Flash Point (°F)	Container or IBC Capacity (gal)	Packaging	Maximum Storage Height (ft)	Maximum Ceiling Height (ft)	Minimum Aisle Width (ft)	Rack Depth (ft)	Sprinkler Protection		Fire Test Ref. [See Table D.2(e)]
							Ceiling Sprinkler Type	Design	
≥200	≤5	Plastic containers, cartoned or uncartoned	Unlimited	Unlimited	4	Any	Any	See 16.6.1, Fire Protection System Design Scheme "A"	1
≥375	≤275	Flexible plastic liner within a composite continuously wound corrugated paperboard intermediate bulk container (See Note 1)	28	30	8	Any	Any	See 16.6.3, Fire Protection System Design Scheme "C"	2
≥375	≤6	Flexible plastic liner within a composite corrugated paperboard box	Unlimited	Unlimited	8	Any	Any	See 16.6.3, Fire Protection System Design Scheme "C"	2

For SI units, 1 gal = 3.8 L, 1 ft = 0.3 m, 200°F = 93°C, 375°F = 190°C.

Note: Construction of intermediate bulk container to be a minimum of 8 layers of paperboard, with a minimum nominal thickness of 1½ in. (38 mm) at the center of any side panel.



**Table 16.5.2.6 Design Criteria for Sprinkler Protection of Shelf Storage of Liquids in Metal Containers**

Container Style and Capacity (gal)	Maximum Storage Height (ft)	Maximum Ceiling Height (ft)	Ceiling Sprinkler Protection				Notes	Fire Test Ref. [See Table D.2(f)]
			Sprinkler		Design			
			Type	Response	Density (gpm/ft <sup>2</sup> )	Area (ft <sup>2</sup> )		
≤1 nonrelieving style	6	18	K≥ 5.6	SR or QR (HT)	0.19	1500	1, 2	1

For SI units, 1 gal = 3.8 L, 1 ft = 0.3 m, 1 ft<sup>2</sup> = 0.09 m<sup>2</sup>, 1 gpm/ft<sup>2</sup> = 40.7 L/min/m<sup>2</sup> = 40.7 mm/min.

For definitions of abbreviations used in the Response column, see 16.5.1.9(4). See also 16.5.1.9(5).

Notes:

- (1) Protection limited to mercantile shelving that is 2 ft (600 mm) or less in depth per side, with backing between each side.
- (2) Minimum hose stream demand can be reduced to 250 gpm for 2 hours.
- (3) The minimum aisle width shall not be less than 5 ft (1.5 m).

**16.5.2.7** Table 16.5.2.7 shall apply to the following:

- (1) Automatic sprinkler protection
- (2) Single- or double-row rack storage
- (3) Water-miscible liquids with concentration of flammable or combustible component greater than 50 percent by volume
- (4) Glass or plastic containers
- (5) Cartoned or uncartoned
- (6) Minimum 8 ft (2.4 m) aisle width

**16.5.2.8** Table 16.5.2.8 shall apply to the following:

- (1) Automatic sprinkler protection
- (2) Single- or double-row rack storage or palletized storage
- (3) Nonmiscible liquids and miscible liquids with concentration of flammable or combustible component greater than 50 percent by volume
- (4) Relieving-style metal containers

**16.5.2.9** Table 16.5.2.9 shall apply to the following:

- (1) Automatic sprinkler protection
- (2) Palletized storage
- (3) Class II and Class III nonmiscible and Class II and Class III miscible liquids
- (4) Listed and labeled rigid nonmetallic intermediate bulk containers

**16.5.2.10** Table 16.5.2.10 shall apply to the following:

- (1) Automatic sprinkler protection
- (2) Single- or double-row rack storage
- (3) Class II and Class III nonmiscible and Class II and Class III miscible liquids
- (4) Listed and labeled rigid nonmetallic intermediate bulk containers

**16.5.2.11** Table 16.5.2.11 shall apply to the following:

- (1) Automatic sprinkler protection
- (2) Palletized or stacked storage
- (3) Unsaturated polyester resins (UPRs) with not more than 50 percent by weight of Class IC, II, or IIIA liquid
- (4) Metal containers; nonrelieving style allowed only up to 6 gal (23 L)

**16.5.2.12** Table 16.5.2.12 shall apply to the following:

- (1) Automatic sprinkler protection
- (2) Palletized or stacked storage
- (3) Miscible liquids with concentration of flammable or combustible components no greater than 80 percent by volume
- (4) Glass or plastic containers

**Table 16.5.2.7 Design Criteria for Sprinkler Protection of Single- and Double-Row Rack Storage of Water-Miscible Liquids in Glass or Plastic Containers**

Container Style and Capacity	Maximum Storage Height (ft)	Maximum Ceiling Height (ft)	Ceiling Sprinkler Protection		Notes	Fire Test Ref. [See Table D.2(g)]
			Ceiling Sprinkler Protection	In-Rack Sprinklers		
16 oz, cartoned	Unlimited	Unlimited	See 16.6.1, Fire Protection System Design Scheme "A"	See 16.6.1, Fire Protection System Design Scheme "A"	1, 2	3
≤1 gal, cartoned	Unlimited	Unlimited	See 16.6.2, Fire Protection System Design Scheme "B"	See 16.6.2, Fire Protection System Design Scheme "B"	1, 2	1
≤60 gal, cartoned or uncartoned	25	30	See 16.6.2, Fire Protection System Design Scheme "B"	See 16.6.2, Fire Protection System Design Scheme "B"	1, 2	2

For SI units, 1 gal = 3.8 L, 1 ft = 0.3 m.

Notes:

- (1) Minimum aisle width in all cases is 8 ft (2.4 m).
- (2) Maximum rack depth in all cases is 9 ft (2.7 m).



**Table 16.5.2.8 Design Criteria for Single-Row Rack, Double-Row Rack, and Palletized Storage of Liquids in Relieving-Style Metal Containers**

Container Style and Capacity (gal)	Maximum Storage Height (ft)	Maximum Ceiling Height (ft)	Ceiling Sprinkler Protection		In-Rack Sprinkler Protection				Fire Test Ref. [See Table D.2(h)]	
			Sprinkler Type	Design (Number of Sprinklers @ Stated Pressure)	Sprinkler		Minimum Discharge Flow	Layout (See 16.5.1.10 & 16.6.4)		Notes
<b>LIQUID CLASSES IB, IC, II, IIIA, IIIB</b>										
<b>RACK STORAGE with MAXIMUM 6 ft RACK DEPTH and MINIMUM 7.5 ft AISLE WIDTH</b>										
≤5, cartoned or uncartoned	14	24	Pendent ESFR K≥14.0 (OT)	12 @ 50 psi	K = 11.2	QR (OT) QR (OT)	36 gpm	7	1, 2, 3, 4, 5, 6, 7	1
	14	24	Pendent ESFR K≥25.0 (OT)	12 @ 25 psi						
<b>LIQUID CLASSES IB, IC, II, IIIA, IIIB</b>										
<b>RACK STORAGE with MAXIMUM 9 ft RACK DEPTH and 8 ft MINIMUM AISLE WIDTH</b>										
≤1, cartoned only	20	30	Pendent ESFR K≥14.0 (OT)	12 @ 75 psi	No in-rack sprinklers required				—	3
≤1, cartoned only	25	30	Pendent ESFR K≥14.0 (OT)	12 @ 50 psi	K = 8.0	QR (OT)	31 gpm	8	1, 2, 5, 7	4
≤5, cartoned or uncartoned	25	30	Pendent ESFR K≥14.0 (OT)	12 @ 75 psi	K = 8.0	QR (OT)	44 gpm	9	1, 2, 5, 7	5
<b>LIQUID CLASSES IB, IC, II, IIIA, IIIB PALLETIZED STORAGE with MINIMUM 7.5 ft AISLE WIDTH</b>										
≤1, cartoned only	8	30	Pendent ESFR K≥14.0 (OT)	12 @ 50 psi	—	—	—	—	—	6
≤5, cartoned or uncartoned	12	30	Pendent ESFR K≥14.0 (OT)	12 @ 75 psi	—	—	—	—	—	7

For SI units, 1 gal = 3.8 L, 1 ft = 0.3 m, 1 psi = 6.9 kPa.

For definitions of abbreviations used in the Response column, see 16.5.1.9(4). See also 16.5.1.9(5).

Notes:

(1) The in-rack sprinkler water demand shall be based on the simultaneous operation of the most hydraulically remote sprinklers as follows:

(a) Seven sprinklers where only one level of in-rack sprinklers is installed.

(b) Fourteen sprinklers (seven on each of the two top levels) where more than one level of in-rack sprinklers is installed.

(2) The in-rack sprinkler water demand should be balanced with the ceiling sprinkler water demand at their point of connection.

(3) One-gallon and 1-quart containers are not required to be relieving style.

(4) Provide minimum 3 in. transverse flue at rack uprights.

(5) For Class IIIB liquids, see also Table 16.5.2.5.

(6) Racks can have open-mesh wire intermediate shelving on lower levels.

(7) The minimum in-rack sprinkler discharge pressure shall not be less than a gauge pressure of 10 psi.



**Table 16.5.2.9 Design Criteria for Sprinkler Protection of Palletized Storage of Class II and Class III Liquids in Listed and Labeled Rigid Nonmetallic IBCs**

Maximum Capacity (gal)	Maximum Storage Height	Maximum Ceiling Height (ft)	Ceiling Sprinkler Protection				Notes	Fire Test Ref. [See Table D.2(i)]
			Sprinkler		Design			
			Type	Response	Density (gpm/ft <sup>2</sup> )	Area (ft <sup>2</sup> )		
793	1-high	30	K≥11.2	SR (HT)	0.45	3000	1, 2, 4	1
793	2-high	30	K≥11.2	SR (HT)	0.60	3000	1, 2, 3, 4	2

For SI units, 1 gal = 3.8 L, 1 ft = 0.3 m, 1 gpm/ft<sup>2</sup> = 40.7 L/min/m<sup>2</sup> = 40.7 mm/min, 1 ft<sup>2</sup> = 0.9 m<sup>2</sup>.

For definitions of abbreviations used in the Response column, see 16.5.1.9(4). See also 16.5.1.9(5).

Notes:

(1) Foam-water sprinkler protection shall be permitted to be substituted for water sprinkler protection, provided the same design criteria are used.

(2) Rigid nonmetallic intermediate bulk containers shall be listed and labeled in accordance with UL 2368, *Standard for Fire Exposure Testing of Intermediate Bulk Containers for Flammable and Combustible Liquids*; FM Class 6020, *Approval Standard for Intermediate Bulk Containers*; or an equivalent test procedure.

(3) The sprinkler operating gauge pressure shall be a minimum 30 psi (207 kPa).

**Table 16.5.2.10 Design Criteria for Sprinkler Protection of Single- and Double-Row Rack Storage of Class II and Class III Liquids in Listed and Labeled Rigid Nonmetallic IBCs**

Maximum Capacity (gal)	Maximum Storage Height (ft)	Maximum Ceiling Height (ft)	Ceiling Sprinkler Protection		Notes	Fire Test Ref. [See Table D.2(j)]
			Sprinkler Type	Design		
793	25	30	Standard spray	See 16.6.2, Fire Protection System Design Scheme "B"	1, 2, 3, 4	1

For SI units, 1 gal = 3.8 L, 1 ft = 0.3 m.

Notes:

(1) Rigid nonmetallic intermediate bulk containers are listed and labeled in accordance with UL 2368, *Standard for Fire Exposure Testing of Intermediate Bulk Containers for Flammable and Combustible Liquids*, or an equivalent test procedure.

(2) Maximum rack depth is 9 ft (2.7 m).

(3) Minimum aisle width is 8 ft (2.4 m).

**Table 16.5.2.11 Design Criteria for Sprinkler Protection of Palletized or Stacked Storage of Unsaturated Polyester Resins in Metal Containers**

Capacity (gal)	Maximum Storage Height (ft)	Maximum Ceiling Height (ft)	Ceiling Sprinkler Protection				Notes	Fire Test Ref. [See Table D.2(k)]
			Sprinkler		Design			
			Type	Response	Density (gpm/ft <sup>2</sup> )	Area (ft <sup>2</sup> )		
>5 and <60	10	33	K≥11.2	SR (HT or OT)	0.45	3000	1, 2, 3	1

For SI units, 1 gal = 3.8 L, 1 ft = 0.3 m, 1 ft<sup>2</sup> = 0.09 m<sup>2</sup>, 1 gpm/ft<sup>2</sup> = 40.7 L/min/m<sup>2</sup> = 40.7 mm/min.

For definitions of abbreviations used in the Response column, see 16.5.1.9(4). See also 16.5.1.9(5).

Notes:

(1) Drums placed on open, slatted pallet, not nested, to allow pressure relief from drums on lower levels.

(2) Storage areas containing unsaturated polyester resin (UPR) should not be located in the same spill containment area or drainage path of other Class I or Class II liquids, unless protected as required for such other liquids.

(3) Both ¾ in. (20 mm) and 2 in. (50 mm) listed and labeled pressure-relieving devices are required on containers that exceed 6 gal (23 L) capacity.



**Table 16.5.2.12 Design Criteria for Sprinkler Protection of Palletized or Stacked Storage of Miscible Liquids in Glass or Plastic Containers**

Container Style and Capacity	Maximum Storage Height (ft)	Maximum Ceiling Height (ft)	Ceiling Sprinkler Protection				Notes	Fire Test Ref. [See Table D.2(l)]
			Sprinkler		Design			
			Type	Response	Density (gpm/ft <sup>2</sup> )	Area (ft <sup>2</sup> )		
≤8 oz	5	38	K≥11.2	QR (OT)	0.47	2000	—	P60 and P61

For SI units, 1 gal = 3.8 L, 1 ft = 0.3 m, 1 ft<sup>2</sup> = 0.09 m<sup>2</sup>, 1 gpm/ft<sup>2</sup> = 40.7 L/min/m<sup>2</sup> = 40.7 mm/min. For definitions of abbreviations used in the Response column, see 16.5.1.9(4). See also 16.5.1.9(5).

**16.6 Fire Protection System Design Schemes.**

**16.6.1 Fire Protection System Design Scheme “A.”**

**16.6.1.1** Horizontal barriers of plywood having a minimum thickness of 3/8 in. (10 mm) or of sheet metal of minimum 22 gauge thickness shall be installed in accordance with Figure 16.6.1.1(a), Figure 16.6.1.1(b), or Figure 16.6.1.1(c), whichever is applicable. All liquid storage shall be located beneath a barrier. [See also 16.6.1.9 for liquids with flash points equal to or greater than 450°F (230°C).]

**16.6.1.2** In-rack sprinklers shall be installed in accordance with Figure 16.6.1.1(a), Figure 16.6.1.1(b), or Figure 16.6.1.1(c), whichever is applicable.

**16.6.1.3** Vertical barriers shall not be provided between in-rack sprinklers.

**16.6.1.4** In-rack sprinklers shall meet the following requirements:

- (1) In-rack sprinklers shall be ordinary temperature-rated quick-response sprinklers and shall have a nominal

K-factor equal to or greater than 8.0. Intermediate-temperature sprinklers shall be used where ambient conditions require.

- (2) In-rack sprinklers shall be installed below each barrier level.
- (3) In-rack sprinklers shall provide a minimum operating flow of 57 gpm out of each of the hydraulically most remote six sprinklers (three on two lines) if one barrier level is provided, or out of each of the hydraulically most remote eight sprinklers (four on two lines) if two or more barrier levels are provided. The minimum in-rack sprinkler discharge pressure shall not be less than a gauge pressure of 10 psi.

**16.6.1.5\*** Where adjacent rack bays are not dedicated to storage of liquids, the barrier and in-rack sprinkler protection shall be extended at least 8 ft (2.4 m) beyond the area devoted to liquid storage. In addition, barrier and in-rack sprinkler protection shall be provided for any rack across the aisle within 8 ft (2.4 m) of the perimeter of the liquid storage in accordance with 16.6.1.

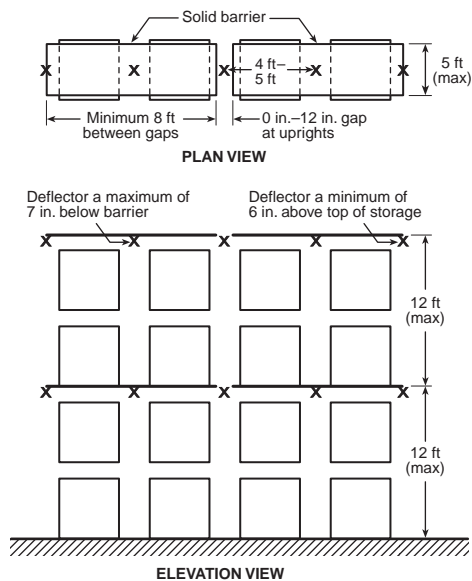

Notes: (1) For SI units, 1 in. = 25 mm; 1 ft = 0.3 m.  
 (2) X denotes K-8.0, ordinary, QR in-rack sprinkler.

**FIGURE 16.6.1.1(a) Single-Row Rack Sprinkler Layout for Design Scheme “A.”**

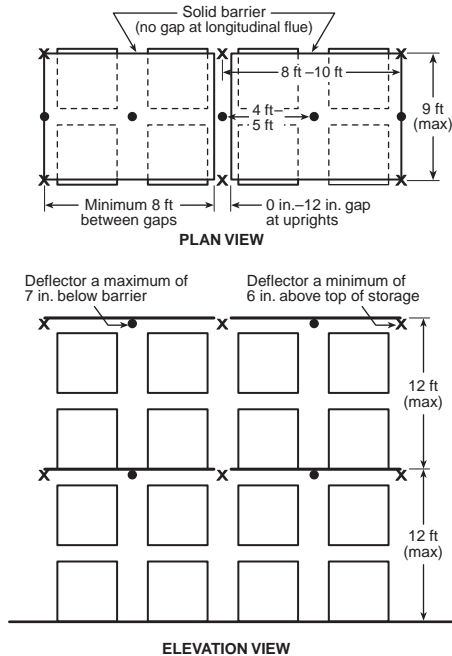

Notes: (1) For SI units, 1 in. = 25 mm; 1 ft = 0.3 m.  
 (2) ● denotes K-8.0, ordinary, QR longitudinal flue sprinkler.  
 (3) X denotes K-8.0, ordinary, QR face sprinkler.

**FIGURE 16.6.1.1(b) Double-Row Rack Sprinkler Layout for Design Scheme “A.”**

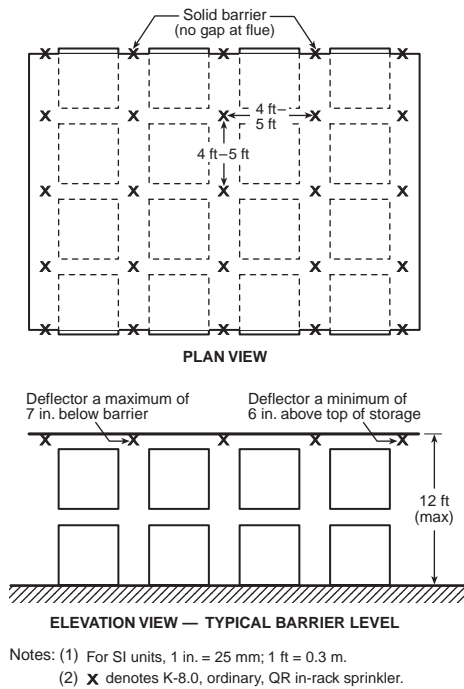

**FIGURE 16.6.1.1(c) Multiple-Row Rack Sprinkler Layout for Design Scheme “A.”**

**16.6.1.6** Ceiling sprinkler demand shall not be included in the hydraulic calculations for in-rack sprinklers.

**16.6.1.7** Water demand at point of supply shall be calculated separately for in-rack and ceiling sprinklers and shall be based on the greater demand.

**16.6.1.8** Ceiling sprinklers shall meet the following requirements:

- (1) Ceiling sprinkler protection shall be designed to protect the surrounding occupancy.
- (2) Any sprinkler type shall be acceptable.
- (3) If standard spray sprinklers are used, they shall be capable of providing not less than 0.20 gpm/ft<sup>2</sup> over 3000 ft<sup>2</sup> (8 mm/min over 270 m<sup>2</sup>).
- (4) If the liquid storage does not extend to the full height of the rack, protection for commodities stored above the top horizontal barrier shall meet the requirements of NFPA 13, *Standard for the Installation of Sprinkler Systems*, for the commodities stored, based on the full height of the rack.

**16.6.1.9** Barriers shall not be required for liquids with closed-cup flash points of 450°F (230°C) or greater. If barriers are omitted, the following shall apply:

- (1) Ceiling sprinkler protection shall provide a minimum density of 0.3 gpm/ft<sup>2</sup> over the most hydraulically remote 2000 ft<sup>2</sup> (12 mm/min over 180 m<sup>2</sup>) using ordinary-temperature, standard-response sprinklers. Sprinklers shall have a nominal K-factor equal to or greater than 8.0. Intermediate-temperature sprinklers shall be used where ambient conditions require.
- (2) The ceiling sprinkler water demand and the in-rack water demand shall be balanced at their point of connection.
- (3) The sprinklers located at the rack face shall be staggered vertically.

**16.6.1.10** A 500 gpm (1900 L/min) hose stream allowance shall be provided.

### 16.6.2 Fire Protection System Design Scheme “B.”

**16.6.2.1** Horizontal barriers of plywood having a minimum thickness of 3/8 in. (10 mm) or of sheet metal of minimum 22 gauge thickness shall be installed in accordance with Figure 16.6.2.1(a), Figure 16.6.2.1(b), or Figure 16.6.2.1(c), whichever is applicable. All liquid storage shall be located beneath a barrier.

**16.6.2.2** In-rack sprinklers shall be installed in accordance with Figure 16.6.2.1(a), Figure 16.6.2.1(b), or Figure 16.6.2.1(c), whichever is applicable.

**16.6.2.3** Vertical barriers shall not be provided between in-rack sprinklers.

**16.6.2.4** In-rack sprinklers shall meet the following requirements:

- (1) In-rack sprinklers shall be ordinary temperature-rated quick-response sprinklers and shall have a nominal K-factor equal to or greater than 8.0. Intermediate-temperature sprinklers shall be used where ambient conditions require.
- (2) In-rack sprinklers shall be installed below each barrier level.
- (3) For containers that do not exceed 60 gal (230 L) capacity and where there is only one horizontal barrier, in-rack sprinklers shall provide a minimum discharge flow of 57 gpm out of each of the hydraulically most remote six sprinklers (three on two lines) if one barrier level is provided, or out of each of the hydraulically most remote eight sprinklers (four on two lines) if two or more barrier levels are provided. The minimum in-rack sprinkler discharge pressure shall not be less than a gauge pressure of 10 psi.

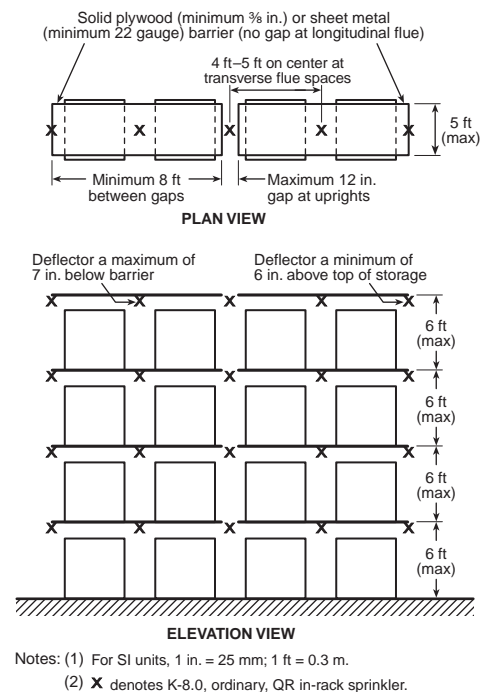

**FIGURE 16.6.2.1(a) Single-Row Rack Sprinkler Layout for Design Scheme “B” — Sprinklers in Center of Rack.**

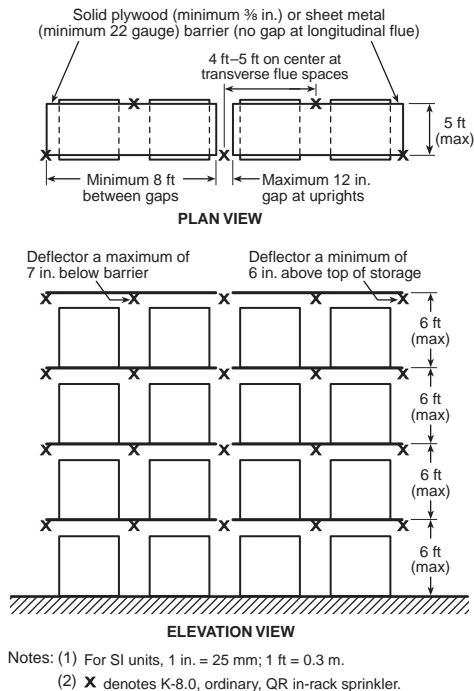

FIGURE 16.6.2.1(b) Single-Row Rack Sprinkler Layout for Design Scheme “B” — Sprinklers on Face of Rack.

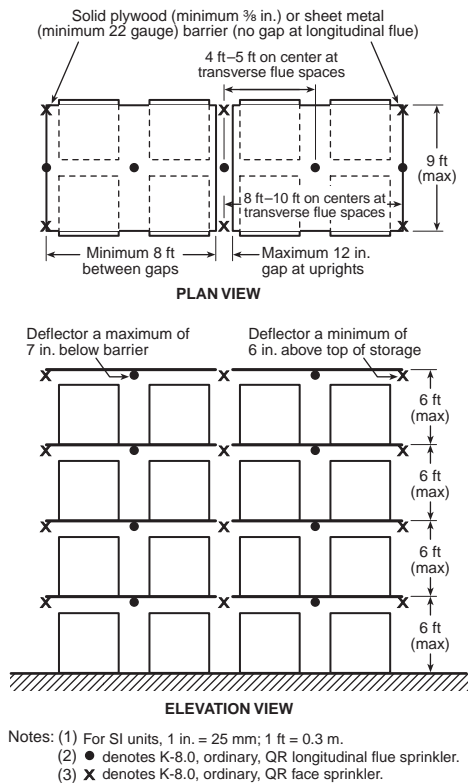

FIGURE 16.6.2.1(c) Double-Row Rack Sprinkler Layout for Design Scheme “B.”

(4) For containers that exceed 60 gal (230 L) capacity, but do not exceed 793 gal (3000 L), in-rack sprinklers shall provide a minimum discharge flow of 57 gpm out of each of the hydraulically most remote 12 sprinklers, six each on two lines. The minimum in-rack sprinkler discharge pressure shall not be less than a gauge pressure of 10 psi.

**16.6.2.5** If there are adjacent rack bays that are not dedicated to storage of liquids, the barrier and in-rack sprinkler protection shall be extended beyond the area devoted to liquid storage as follows:

- (1) For containers that do not exceed 1 gal (3.8 L) capacity, protection shall be extended at least 8 ft (2.4 m) beyond the area devoted to liquid storage. In addition, adjacent racks across the aisles on each side of the liquid storage shall be protected in accordance with NFPA 13, *Standard for the Installation of Sprinkler Systems*, for the commodity stored.
- (2) For containers that exceed 1 gal (3.8 L) capacity, but do not exceed 793 gal (3000 L), protection shall be extended at least 8 ft (2.4 m) beyond the area devoted to liquid storage. In addition, protection shall be provided for any rack across the aisle within 8 ft (2.4 m) of the perimeter of the liquid storage in accordance with 16.6.2.

**16.6.2.6** Ceiling sprinklers for containers that do not exceed 1 gal (3.8 L) capacity shall meet the following requirements:

- (1) Ceiling sprinklers shall be designed to protect the surrounding occupancy.
- (2) Ceiling sprinkler water demand shall not be included in the hydraulic calculations for the in-rack sprinkler protection.
- (3) Water demand at the point of supply shall be calculated separately for in-rack and ceiling sprinklers and shall be based on the greater of the two.
- (4) Any sprinkler type shall be acceptable for the ceiling sprinkler protection.
- (5) If standard spray sprinklers are used, they shall be capable of providing not less than 0.20 gpm/ft<sup>2</sup> over 3000 ft<sup>2</sup> (8 L/min over 270 m<sup>2</sup>).
- (6) If the liquid storage does not extend to the full height of the rack, protection for commodities stored above the top horizontal barrier shall meet the requirements of NFPA 13, *Standard for the Installation of Sprinkler Systems*, for the commodities stored, based on the full height of the rack.

**16.6.2.7** Ceiling sprinklers for containers that exceed 1 gal (3.8 L) capacity, but do not exceed 60 gal (230 L), shall meet the following requirements:

- (1) Ceiling sprinkler protection shall provide a minimum density of 0.45 gpm/ft<sup>2</sup> (18.3 mm/min) over the most hydraulically remote 3000 ft<sup>2</sup> (270 m<sup>2</sup>), using high-temperature, standard-response sprinklers of nominal K-factor of 11.2 or greater. Other types of sprinklers shall not be used.
- (2) Ceiling sprinkler water demand and the in-rack sprinkler demand shall be balanced at the point of connection.

**16.6.2.8** Ceiling sprinklers for containers that exceed 60 gal (230 L) capacity, but do not exceed 793 gal (3000 L), shall meet the following requirements:

- (1) Ceiling sprinklers shall be designed to provide a minimum density of 0.60 gpm/ft<sup>2</sup> over 3000 ft<sup>2</sup> (24 mm/min over the most remote 270 m<sup>2</sup>), using high-temperature-rated, standard-response sprinklers of nominal K-factor of 11.2 or greater. Other types of sprinklers shall not be used.
- (2) Ceiling sprinkler water demand and the in-rack sprinkler demand shall be balanced at the point of connection.

**16.6.2.9** A 500 gpm (1900 L/min) hose stream allowance shall be provided.

**16.6.3 Fire Protection System Design Scheme “C.”**

**16.6.3.1** Horizontal barriers of plywood having a minimum thickness of 3/8 in. (10 mm) or of sheet metal of minimum 22 gauge thickness shall be installed in accordance with Figure 16.6.3.1(a), Figure 16.6.3.1(b), or Figure 16.6.3.1(c), whichever is applicable. All liquid storage shall be located beneath a barrier.

**16.6.3.2** Vertical baffles shall not be installed between in-rack sprinklers.

**16.6.3.3** In-rack sprinklers shall meet the following requirements:

- (1) In-rack sprinklers shall be ordinary temperature-rated, quick-response sprinklers. Sprinklers shall have a nominal K-factor equal to or greater than 8.0. An intermediate-temperature sprinkler shall be used where ambient conditions require.
- (2) In-rack sprinklers shall be installed below each barrier level.
- (3) In-rack sprinklers shall provide a minimum discharge flow of 30 gpm out of each of the hydraulically most remote six sprinklers (three on two lines) if one barrier level is provided, or out of each of the hydraulically most remote eight sprinklers (four on two lines) if two or more barrier levels are provided. The minimum in-rack sprinkler discharge pressure shall not be less than a gauge pressure of 10 psi.

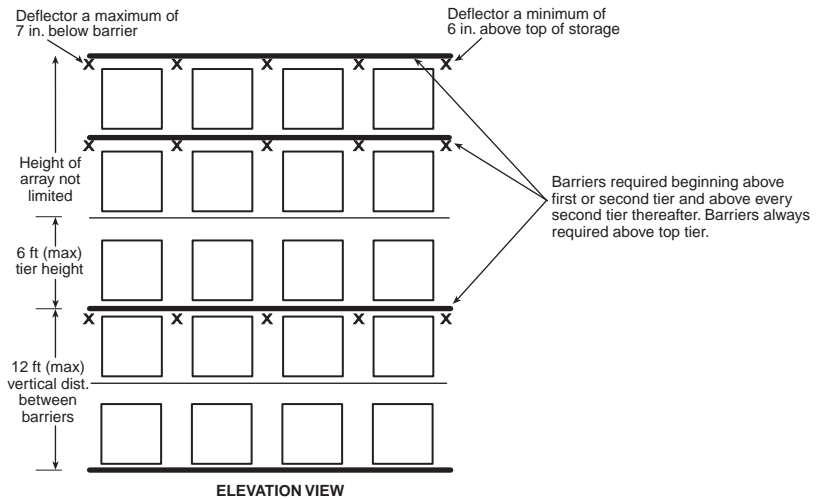
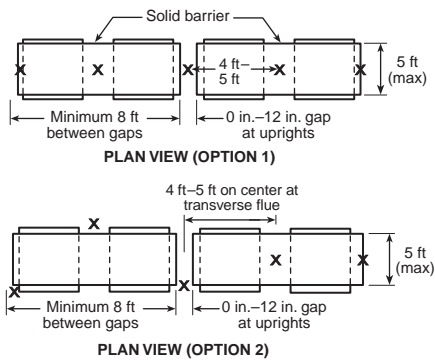

Notes: (1) For SI units, 1 in. = 25 mm; 1 ft = 0.3 m.  
 (2) X denotes K-8.0, ordinary, QR face sprinkler.

**FIGURE 16.6.3.1(a) Single-Row Rack Sprinkler Layout for Design Scheme “C.”**

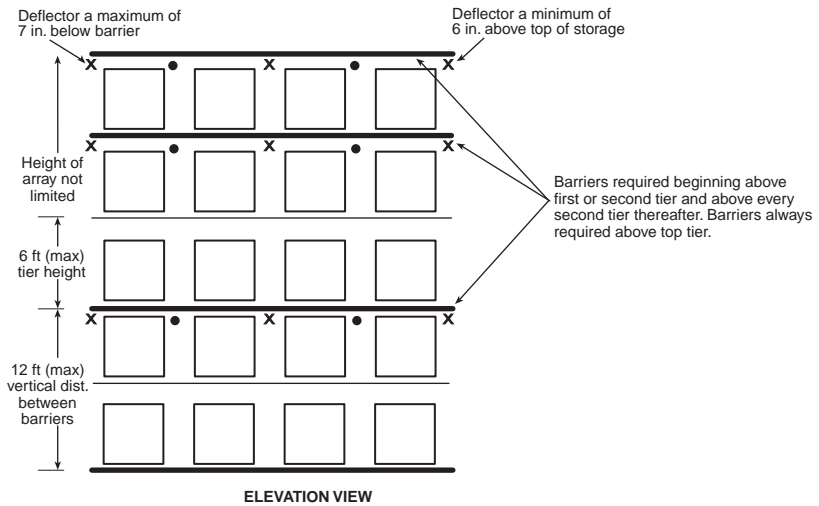
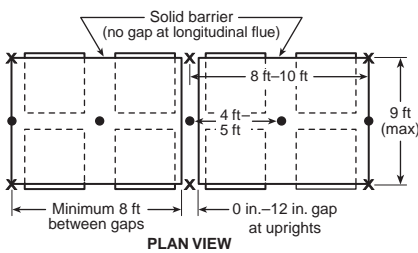

Notes: (1) For SI units, 1 in. = 25 mm; 1 ft = 0.3 m.  
 (2) X denotes K-8.0, ordinary, QR face sprinkler.  
 ● denotes K-8.0, ordinary, QR flue sprinkler.

**FIGURE 16.6.3.1(b) Double-Row Rack Sprinkler Layout for Design Scheme “C.”**

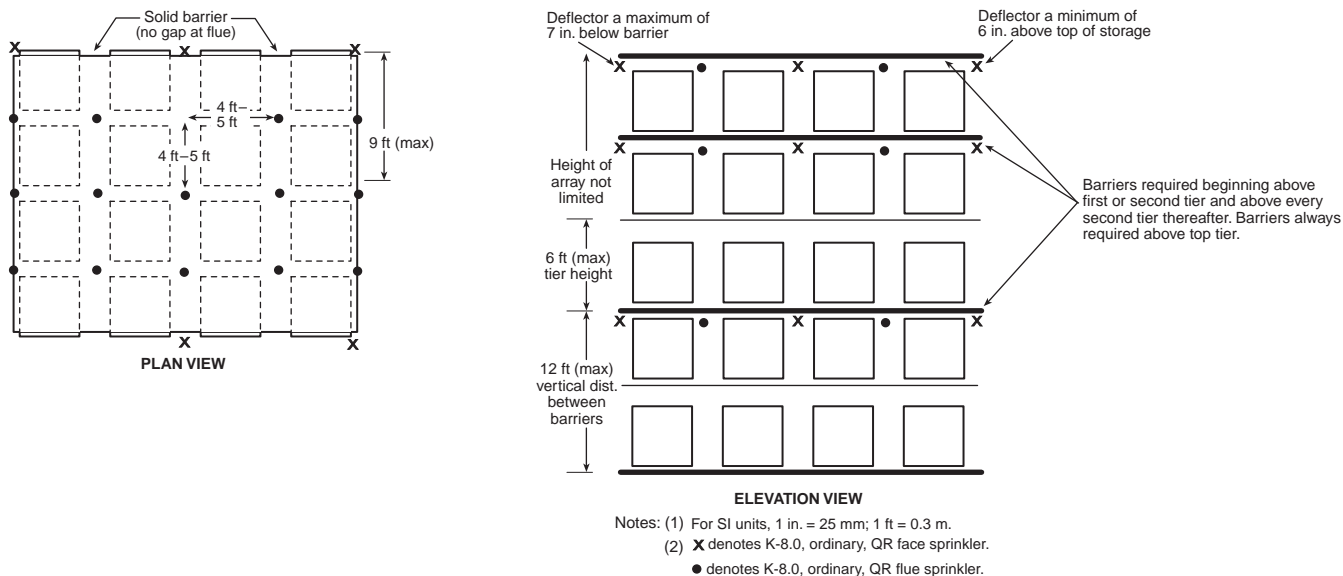

FIGURE 16.6.3.1(c) Multiple-Row Rack Sprinkler Layout for Design Scheme “C.”

**16.6.3.4** If there are adjacent bays of in-rack arrays that are not dedicated to storage of liquids, the barrier and in-rack sprinkler protection shall be extended at least 8 ft (2.4 m) beyond the area devoted to liquid storage.

**16.6.3.5** Ceiling sprinkler demand shall not be included in the hydraulic calculations for in-rack sprinklers.

**16.6.3.6** Water demand at point of supply shall be calculated separately for in-rack and ceiling sprinklers and shall be based on the greater demand.

**16.6.3.7** Ceiling sprinklers shall meet the following requirements:

- (1) Ceiling sprinkler protection shall be designed to protect the surrounding occupancy.
- (2) Any sprinkler type shall be acceptable.
- (3) If standard spray sprinklers are used, they shall be capable of providing not less than 0.20 gpm/ft<sup>2</sup> over 3000 ft<sup>2</sup> (8 mm/min over 270 m<sup>2</sup>).
- (4) If the liquid storage does not extend to the full height of the rack, protection for commodities stored above the top horizontal barrier shall meet the requirements of NFPA 13, *Standard for the Installation of Sprinkler Systems*, for the commodities stored, based on the full height of the rack.

**16.6.3.8** A 500 gpm (1900 L/min) hose stream allowance shall be provided.

**16.6.4 In-Rack Sprinkler Layouts for Table 16.5.2.8.** Where indicated in Table 16.5.2.8, in-rack sprinklers shall be as follows:

- (1) Where Layout 7 is required, in-rack sprinklers shall be installed in accordance with Figure 16.6.4(a).
- (2) Where Layout 8 is required, in-rack sprinklers shall be installed in accordance with Figure 16.6.4(b) or Figure 16.6.4(c).
- (3) Where Layout 9 is required, in-rack sprinklers shall be installed in accordance with Figure 16.6.4(d) or Figure 16.6.4(e), whichever is applicable.

**16.7 Water Supply.** Water supplies for automatic sprinklers, other water-based protection systems, hose streams, and hydrants shall be capable of supplying the anticipated water flow demand for a minimum of 2 hours.

**16.8 Containment, Drainage, and Spill Control.**

**16.8.1** Containment or containment and drainage shall be provided in accordance with Figure 16.8.1, when protection systems are installed in accordance with the provisions of this chapter.

**16.8.2\*** Where control of the spread of liquid is required, means to limit the spread of liquid to an area not greater than the design discharge area of the ceiling sprinkler system shall be provided.

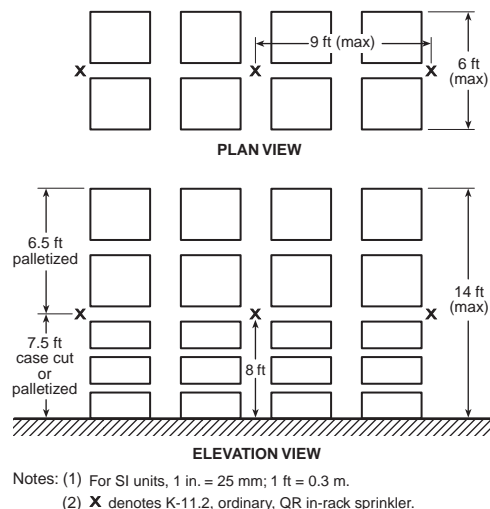
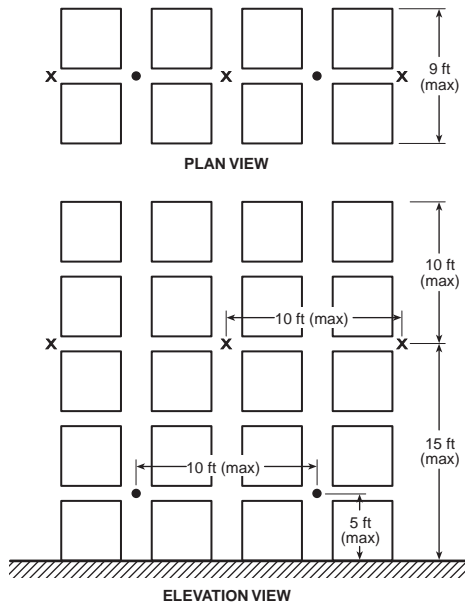
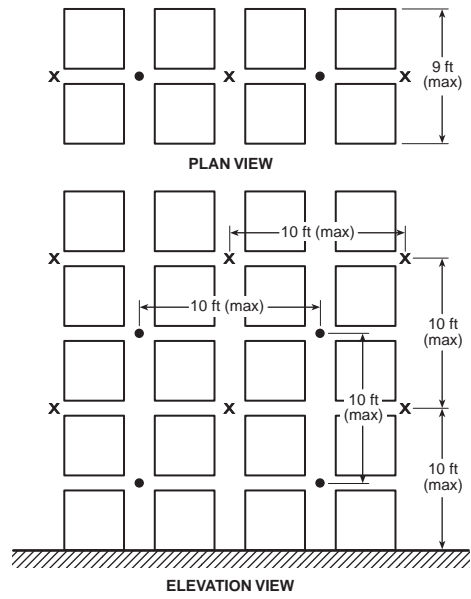

FIGURE 16.6.4(a) Double-Row Rack Sprinkler Layout 7.



Notes: (1) For SI units, 1 in. = 25 mm; 1 ft = 0.3 m.  
 (2) ● and X denote K-8.0, QR in-rack sprinklers.

FIGURE 16.6.4(b) Double-Row Rack Sprinkler Layout 8 — Option #1.



Notes: (1) For SI units, 1 in. = 25 mm; 1 ft = 0.3 m.  
 (2) ● and X denote K-8.0, QR in-rack sprinklers.

FIGURE 16.6.4(d) Double-Row Rack Sprinkler Layout 9 — Option #1.

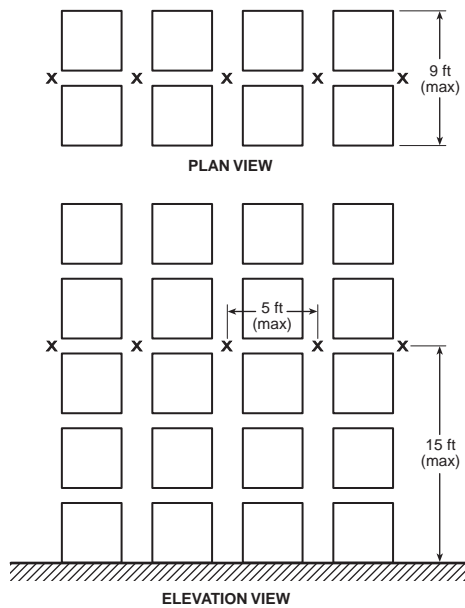

Notes: (1) For SI units, 1 in. = 25 mm; 1 ft = 0.3 m.  
 (2) X denotes K-8.0, QR in-rack sprinkler.

FIGURE 16.6.4(c) Double-Row Rack Sprinkler Layout 8 — Option #2.

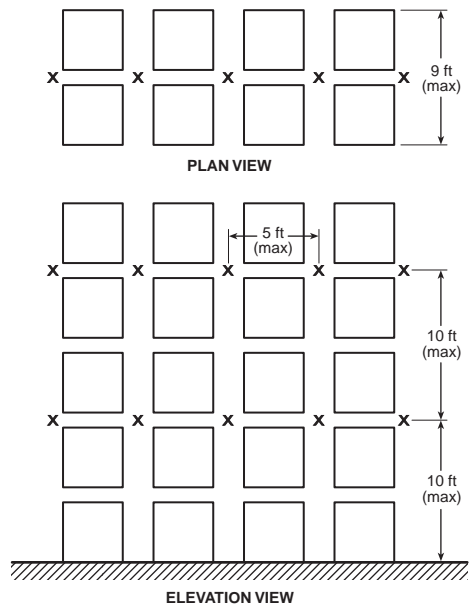

Notes: (1) For SI units, 1 in. = 25 mm; 1 ft = 0.3 m.  
 (2) X denotes K-8.0, QR in-rack sprinkler.

FIGURE 16.6.4(e) Double-Row Rack Sprinkler Layout 9 — Option #2.

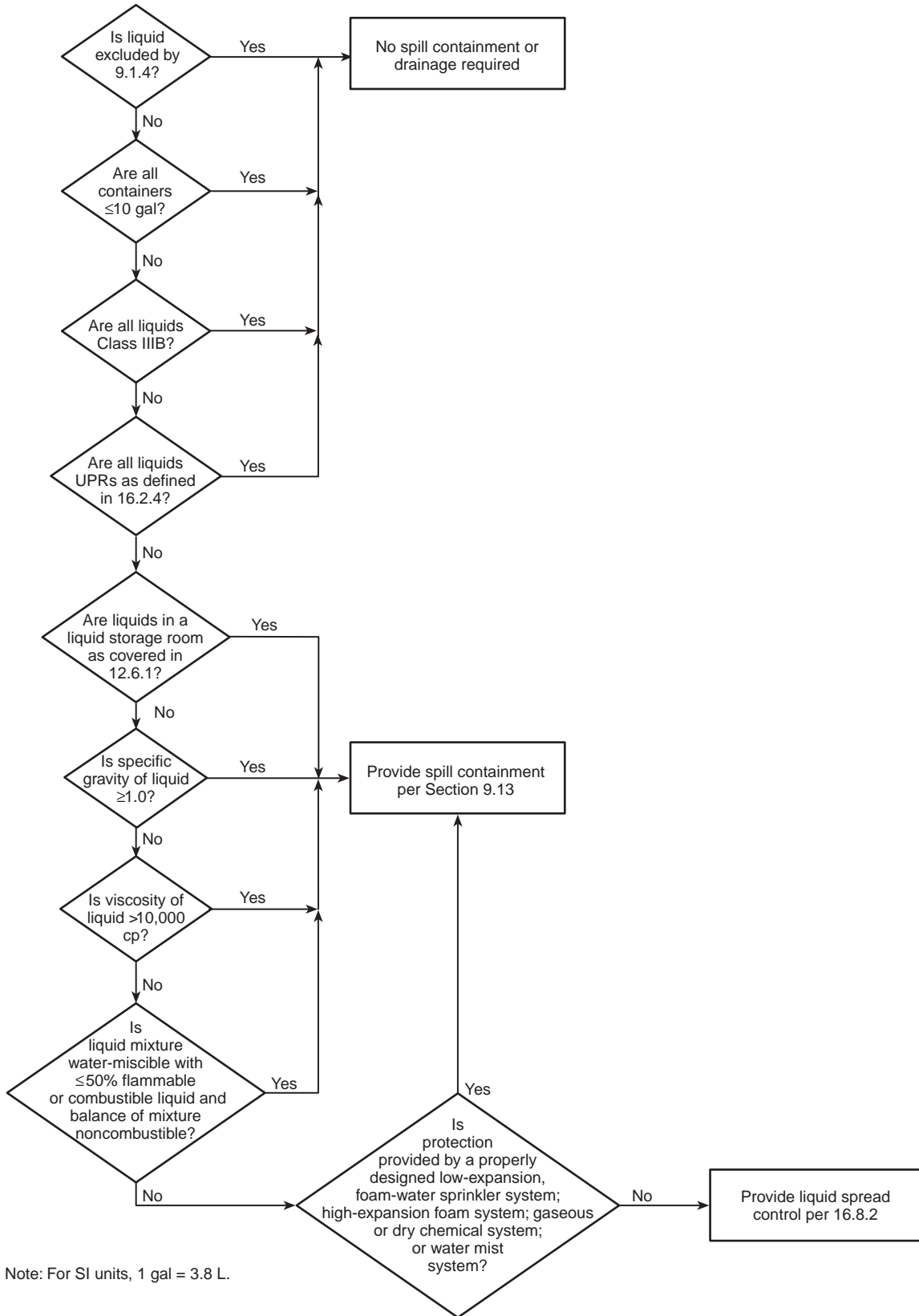

FIGURE 16.8.1 Spill Containment and Liquid Spread Control for Protected Storage.



**16.9 Other Automatic Fire Protection Systems.** Alternate fire protection systems, such as automatic water spray systems, automatic water mist systems, high-expansion foam systems, dry chemical extinguishing systems, alternate sprinkler system configurations, or combinations of systems shall be permitted if approved by the authority having jurisdiction. Such alternate systems shall be designed and installed in accordance with the appropriate NFPA standard and with manufacturer's recommendations for the system(s) selected.

## Chapter 17 Processing Facilities

### 17.1 Scope.

**17.1.1\*** This chapter shall apply where the processing of liquids is the principal activity, except as covered elsewhere in this code or in other NFPA standards. (See 1.5.3.)

**17.1.2** Provisions of this chapter shall not prohibit the use of movable tanks for the dispensing of flammable or combustible liquids into fuel tanks of motorized equipment outside on premises not accessible to the public, where such use has the approval of the authority having jurisdiction.

### 17.2 Definitions Specific to Chapter 17. (Reserved)

### 17.3 General Requirements.

**17.3.1\*** Liquid processing operations shall be located and operated so that they do not constitute a significant fire or explosion hazard to life, to property of others, or to important buildings or facilities within the same plant.

**17.3.2** Specific requirements shall depend on the inherent risk in the operations themselves, including the liquids being processed, operating temperatures and pressures, and the capability to control any liquid or vapor releases or fire incidents that could occur.

**17.3.3** The interrelationship of the many factors involved shall be based on good engineering and management practices to establish suitable physical and operating requirements.

**17.3.4** Process facilities shall comply with the applicable requirements for specific operations set forth in Chapters 18, 19, 28, or 29.

**17.3.5** Process facilities shall comply with the applicable requirements for procedures and practices for fire and explosion prevention, protection, and control set forth in Chapter 6.

**17.3.6** Processing and handling of Class II and Class III liquids heated at or above their flash point shall follow the requirements for Class I liquids, unless an engineering evaluation conducted in accordance with Chapter 6 justifies following the requirements for some other liquid class. (See 6.4.1.2 and A.6.4.1.2.)

**17.3.7** When a process heats a liquid to a temperature at or above its flashpoint, the following shall apply:

- (1) The process vessel shall be closed to the room in which it is located and vented to the outside of the building.
- (2) If the vessel needs to be opened to add ingredients, the room ventilation shall meet the requirements of Section 17.11 and the process heating controls will be interlocked

with the ventilation such that the process heat will shut down if the ventilation fails or is turned off.

- (3) The process vessel shall be equipped with an excess temperature control set to limit excessive heating of the liquid and the subsequent release of vapors.
- (4) If a heat transfer medium is used to heat the liquid and the heat transfer fluid can heat the liquid to its boiling point on failure of the process and excess temperature heat controls, a redundant excess temperature control shall be provided.

### 17.4 Location of Process Vessels and Equipment.

**17.4.1** Liquid-processing vessels and equipment shall be located in accordance with the requirements of this section.

**17.4.2** Processing vessels and buildings containing such processing vessels shall be located so that a fire involving the vessels does not constitute an exposure hazard to other occupancies.

**17.4.3** The minimum distance of a processing vessel to a property line that is or can be built upon, including the opposite side of a public way; to the nearest side of a public way; or to the nearest important building on the same property shall be determined by one of the following:

- (1) In accordance with Table 17.4.3
- (2) In accordance with an engineering evaluation of the process, followed by application of sound fire protection and process engineering principles

**17.4.3.1\*** Processing vessels used solely to process stable Class IIIB liquids shall be located in accordance with Table 22.4.1.6.

**17.4.4** Where process vessels are located in a building and the exterior wall facing the exposure (line of adjoining property that is or can be built upon or nearest important building on the same property) is greater than 25 ft (7.6 m) from the exposure and is a blank wall having a fire resistance rating of not less than 2 hours, any greater distances required by Table 17.4.3 shall be permitted to be waived. If the exterior wall is a blank wall having a fire resistance rating of not less than 4 hours, all distances required by Table 17.4.3 shall be permitted to be waived.

**17.4.5** All the distances given in Table 17.4.3 shall be doubled where protection for exposures is not provided.

**17.4.6\*** Liquid-processing equipment, such as pumps, heaters, filters, and exchangers, shall not be located closer than 25 ft (7.6 m) to property lines where the adjoining property is or can be built upon or to the nearest important building on the same property that is not an integral part of the process. This spacing requirement shall be permitted to be waived where exposures are protected in accordance with 17.4.3.

**17.4.7** Processing equipment in which unstable liquids are handled shall be separated from unrelated plant facilities by either of the following:

- (1) 25 ft (7.6 m) clear spacing
- (2) A wall having a fire resistance rating of not less than 2 hours and explosion resistance consistent with the expected hazard

**17.5 Accessibility.** Each process unit or building containing liquid-processing equipment shall be accessible from at least one side for fire fighting and fire control.



**Table 17.4.3 Location of Process Vessels with Respect to Property Lines, Public Ways, and the Nearest Important Building on the Same Property — Protection for Exposures Is Provided**

Vessel Maximum Operating Liquid Capacity (gal)	Minimum Distance (ft)							
	From Property Line that Is or Can Be Built upon, Including Opposite Side of Public Way				From Nearest Side of Any Public Way or from Nearest Important Building on Same Property that Is Not an Integral Part of the Process			
	Stable Liquid Emergency Relief*		Unstable Liquid Emergency Relief*		Stable Liquid Emergency Relief*		Unstable Liquid Emergency Relief*	
	Not Over 2.5 psi	Over 2.5 psi	Not Over 2.5 psi	Over 2.5 psi	Not Over 2.5 psi	Over 2.5 psi	Not Over 2.5 psi	Over 2.5 psi
275 or less	5	25	50	100	5	25	50	100
276 to 750	10	25	50	100	5	25	50	100
751 to 12,000	15	25	50	100	5	25	50	100
12,001 to 30,000	20	30	50	100	5	25	50	100
30,001 to 50,000	30	45	75	120	10	25	50	100
50,001 to 100,000	50	75	125	200	15	25	50	100
Over 100,000	80	120	200	300	25	40	65	100

For SI units, 1 gal = 3.8 L; 1 ft = 0.3 m; 1 psi = a gauge pressure of 6.9 kPa.  
 Note: Double all of above distances where protection for exposures is not provided.  
 \*Gauge pressure.

**17.6 Construction Requirements.**

**17.6.1** Process buildings or structures used for liquid operations shall be constructed consistent with the operations being conducted and with the classes of liquids handled. They shall be constructed to minimum Type II (000) construction, as defined in *NFPA 5000, Building Construction and Safety Code*, and shall be constructed in accordance with Table 17.6.1.

**17.6.2** Construction types shall be as defined in *NFPA 5000, Building Construction and Safety Code*.

**17.6.3** Where protection for exposures is not provided, the applicable distances given in Table 17.6.1 shall be doubled.

**17.6.4** For buildings or structures that are not provided with approved automatic sprinkler protection, the separation distances otherwise required by Table 17.6.1 shall be determined by an engineering evaluation of the process, but shall not be less than the separation distances required by Table 17.4.3.

**17.6.5** Buildings or structures used solely for blending, mixing, or dispensing of Class IIIB liquids at temperatures below their flash points shall be permitted to be constructed of combustible construction, subject to the approval of the authority having jurisdiction.

**17.6.6** Buildings or structures used for processing or handling of liquids where the quantities of liquids do not exceed 360 gal (1360 L) of Class I and Class II liquids and 720 gal (2725 L) of Class IIIA liquids shall be permitted to be constructed of combustible construction, subject to the approval of the authority having jurisdiction.

**17.6.7** Buildings or structures used for processing or handling of liquids protected with automatic sprinklers or equivalent fire protection systems shall be permitted to be constructed of combustible construction, subject to the approval of the authority having jurisdiction.

**Table 17.6.1 Minimum Separation Distances for Buildings or Structures Used for Liquid Handling and Operations**

Liquid Class	Minimum Type of Construction*	Minimum Separation Distance (ft)	
		To Street, Alley, or Public Way	To Adjacent Property Line that Is or Can Be Built Upon
Class I liquids; unstable liquids of any class; liquids of any class heated above their flash points†	II (222)	5	10
	II (111)	5	25
	II (000)	10	50
Class II	II (111)	5	10
	II (000)	5	25
Class III	II (000)	5	10

For SI units, 1 ft = 0.3 m.  
 Note: Distances apply to properties that have protection for exposures, as defined in this code. If there are exposures for which protection does not exist, the distances should be doubled, in accordance with 17.6.3.  
 \*Construction types are defined in *NFPA 220, Standard on Types of Building Construction*.  
 †For stable liquids of any class heated above their flash points, see 6.4.1.2 and A.6.4.1.2.

**17.6.8\*** Load-bearing building supports and load-bearing supports of vessels and equipment capable of releasing quantities of liquids that could result in a fire capable of causing substantial property damage shall be protected by one or more of the following:

- (1) Drainage to a safe location to prevent liquids from accumulating under vessels or equipment or around load-bearing supports
- (2) Fire-resistive construction
- (3) Fire-resistant protective coatings or systems
- (4) Water spray systems designed and installed in accordance with NFPA 15, *Standard for Water Spray Fixed Systems for Fire Protection*
- (5) Other alternate means acceptable to the authority having jurisdiction

**17.6.9** Class I liquids shall not be handled or used in basements.

**17.6.9.1** Where Class I liquids are handled or used above grade within buildings with basements or closed pits into which flammable vapors can travel, such belowgrade areas shall be provided with mechanical ventilation designed to prevent the accumulation of flammable vapors.

**17.6.9.2** Means shall be provided to prevent liquid spills from running into basements.

**17.6.10\*** Smoke and heat venting shall be permitted to be used where it assists access for fire fighting.

**17.6.11\*** Areas shall have exit facilities arranged to prevent occupants from being trapped in the event of fire.

**17.6.11.1** Exits shall not be exposed by the drainage facilities described in Section 17.10.

**17.6.12** Aisles shall be maintained for unobstructed movement of personnel and fire protection equipment.

**17.6.13** Indoor areas where Class IA or unstable liquids are in use shall be designed to direct flame, combustion gases, and pressures resulting from a deflagration away from important buildings or occupied areas through the use of damage-limiting construction in accordance with NFPA 68, *Standard on Explosion Protection by Deflagration Venting*.

**17.6.13.1** The damage-limiting construction design shall be in accordance with recognized standards and shall be acceptable to the authority having jurisdiction. (See A.9.16.1.)

**17.6.13.2** Where unstable liquids are in use, an approved engineered construction method that is designed to limit damage from an explosion (deflagration or detonation, depending on the characteristics of the liquid) shall be used.

**17.7 Fire Protection. (Reserved)**

**17.8 Emergency Control Systems. (Reserved)**

**17.9 Electrical Systems.** Electrical wiring and electrical utilization equipment shall comply with Chapter 7.

**17.10 Containment, Drainage, and Spill Control.**

**17.10.1\*** Emergency drainage systems shall be provided to direct liquid leakage and fire protection water to a safe location.

**17.10.2** Emergency drainage systems, if connected to public sewers or discharged into public waterways, shall be equipped with traps or separators.

**17.10.3** A facility shall be designed and operated to prevent the discharge of liquids to public waterways, public sewers, or adjoining property.

**17.11 Ventilation.**

**17.11.1** Enclosed processing areas handling or using Class I liquids, or Class II or Class III liquids heated to temperatures

at or above their flash points, shall be ventilated at a rate sufficient to maintain the concentration of vapors within the area at or below 25 percent of the lower flammable limit (LFL). Compliance with 17.11.2 through 17.11.10 shall be deemed as meeting the requirements of this section.

**17.11.2\*** Ventilation requirements shall be confirmed by one of the following:

- (1) Calculations based on the anticipated fugitive emissions (see Annex F for calculation method).
- (2) Sampling of the actual vapor concentration under normal operating conditions. Sampling shall be conducted at a 5 ft (1.5 m) radius from each potential vapor source extending to or toward the bottom and the top of the enclosed processing area. The vapor concentration used to determine the required ventilation rate shall be the highest measured concentration during the sampling procedure.

**17.11.3** A ventilation rate of not less than 1 ft<sup>3</sup>/min/ft<sup>2</sup> (0.3 m<sup>3</sup>/min/m<sup>2</sup>) of solid floor area shall be considered as meeting the requirements of 17.11.1.

**17.11.4** Ventilation shall be accomplished by mechanical or natural means.

**17.11.5** Exhaust ventilation discharge shall be to a safe location outside the building.

**17.11.6** Recirculation of the exhaust air shall be permitted only when it is monitored continuously using a fail-safe system that is designed to automatically sound an alarm, stop recirculation, and provide full exhaust to the outside in the event that vapor-air mixtures in concentrations over one-fourth of the lower flammable limit are detected.

**17.11.7\*** Provision shall be made for introduction of make-up air in such a manner as to avoid short-circuiting the ventilation.

**17.11.8** Ventilation shall be arranged to include all floor areas or pits where flammable vapors can collect.

**17.11.9** Local or spot ventilation to control special fire or health hazards, if provided, shall be permitted to be utilized for up to 75 percent of the required ventilation.

**17.11.10** Where equipment such as dispensing stations, open centrifuges, plate and frame filters, and open vacuum filters is used in a building, the equipment and ventilation of the building shall be designed to limit flammable vapor-air mixtures under normal operating conditions to the interior of equipment and to not more than 5 ft (1.5 m) from equipment that exposes Class I liquids to the air.

**17.12 Explosion Control. (Reserved)**

**17.13 Process Structures. (Reserved)**

**17.14\* Process Equipment and Vessels.** Equipment shall be designed and arranged to prevent the unintentional escape of liquids and vapors and to minimize the quantity escaping in the event of accidental release.

**17.15 Management of Operations Hazards.**

**17.15.1** This section shall apply to the management methodology used to identify, evaluate, and control the hazards involved in processing and handling of flammable and combustible liquids. These hazards include, but are not limited to,



preparation; separation; purification; and change of state, energy content, or composition.

**17.15.2** Operations involving flammable and combustible liquids shall be reviewed to ensure that fire and explosion hazards resulting from loss of containment of liquids are provided with corresponding fire prevention and emergency action plans.

*Exception No. 1: Operations where liquids are used solely for on-site consumption as fuels.*

*Exception No. 2: Operations where Class II or Class III liquids are stored in atmospheric tanks or transferred at temperatures below their flash points.*

*Exception No. 3: Mercantile occupancies, crude petroleum exploration, drillings, and well servicing operations, and normally unoccupied facilities in remote locations.*

**17.15.3** The extent of fire prevention and control that is provided shall be determined by means of an engineering evaluation of the operation and application of sound fire protection and process engineering principles. This evaluation shall include, but not be limited to, the following:

- (1) Analysis of the fire and explosion hazards of the operation
- (2) Analysis of emergency relief from process vessels, taking into consideration the properties of the materials used and the fire-protection and control measures taken
- (3) Analysis of applicable facility design requirements in Section 17.3 through Section 17.4
- (4) Analysis of applicable requirements in Chapters 18, 19, 28, and 29 for liquid handling, transfer, and use
- (5) Analysis of local conditions, such as exposure to and from adjacent properties and exposure to floods, earthquakes, and windstorms
- (6) Analysis of the emergency response capabilities of the local emergency services

**17.15.4** A written emergency action plan that is consistent with available equipment and personnel shall be established to respond to fires and related emergencies. This plan shall include the following:

- (1) Procedures to be followed in case of fire or release of liquids or vapors, such as sounding the alarm, notifying the fire department, evacuating personnel, and controlling and extinguishing the fire
- (2) Procedures and schedules for conducting drills of these procedures
- (3) Appointment and training of personnel to carry out assigned duties, which shall be reviewed at the time of initial assignment, as responsibilities or response actions change, and whenever anticipated duties change
- (4) Procedures for maintenance of the following:
  - (a) Fire protection equipment and systems
  - (b) Drainage and containment systems
  - (c) Ventilation equipment and systems
- (5) Procedures for shutting down or isolating equipment to reduce, control, or stop the release of liquid or vapors, including assigning personnel responsible for maintaining critical plant functions or shutdown of plant processes and safe startup following isolation or shutdown
- (6) Alternative measures for the safety of occupants

**17.15.5** The fire hazards management review conducted in accordance with 17.15.2 shall be repeated whenever the hazards leading to a fire or explosion change significantly. Condi-

tions that might require repeating a review shall include, but are not limited to, the following:

- (1) When changes occur in the materials in process
- (2) When changes occur in process equipment
- (3) When changes occur in process control
- (4) When changes occur in operating procedures or assignments

## Chapter 18 Dispensing, Handling, Transfer, and Use of Liquids

**18.1 Scope.** This chapter applies where liquids are handled, dispensed, transferred, or used, including in process areas.

### 18.2 Definitions Specific to Chapter 18. (Reserved)

**18.3 General Requirements.** Processing and handling of Class II and Class III liquids heated at or above their flash point shall follow the requirements for Class I liquids, unless an engineering evaluation conducted in accordance with Chapter 6 justifies following the requirements for some other liquid class. (*See 6.4.1.2 and A.6.4.1.2.*)

### 18.4 Dispensing, Handling, Transfer, and Use.

**18.4.1** Class I liquids shall be kept in closed tanks or containers when not actually in use. Class II and Class III liquids shall be kept in closed tanks or containers when not actually in use when the ambient or process temperature is at or above their flash points.

**18.4.2** Where liquids are used or handled, provisions shall be made to promptly and safely mitigate and dispose of leakage or spills.

**18.4.3** Class I liquids shall not be used outside closed systems where there are open flames or other ignition sources within the classified areas set forth in Chapter 7.

**18.4.4** Transfer of liquids among vessels, containers, tanks, and piping systems by means of air or inert gas pressure shall be permitted only under all of the following conditions:

- (1) The vessels, containers, tanks, and piping systems shall be designed for such pressurized transfer and shall be capable of withstanding the anticipated operating pressure.
- (2) Safety and operating controls, including pressure-relief devices, shall be provided to prevent overpressure of any part of the system.
- (3) Only inert gas shall be used to transfer Class I liquids. Only inert gas shall be used to transfer Class II and Class III liquids that are heated above their flash points.

**18.4.4.1** Dispensing of Class I liquids from a container by means of air shall be permitted under the following conditions:

- (1) The pressure shall be generated by means of a listed hand-operated device.
- (2) Pressure shall not exceed a gauge pressure of 6 psi (41 kPa) and pressure relief shall be provided.
- (3) The container shall not exceed 119 gal (450 L) and shall be capable of withstanding the maximum pressure generated by the device.
- (4) The device shall be bonded and grounded or shall be demonstrated as not being capable of generating a static charge under any operating condition
- (5) The device shall be constructed of material compatible with the liquid dispensed.

**18.4.5** Positive displacement pumps shall be provided with pressure relief that discharges back to the tank, pump suction, or other suitable location or shall be provided with interlocks to prevent overpressure.

**18.4.6** Piping, valves, and fittings shall meet the requirements of Chapter 27.

**18.4.7** Listed flexible connectors shall be permitted to be used where vibration exists. Approved hose shall be permitted to be used at transfer stations.

**18.4.8\*** The staging of liquids in containers, intermediate bulk containers, and portable tanks shall be limited to the following:

- (1) Containers, intermediate bulk containers, and portable tanks that are in use
- (2) Containers, intermediate bulk containers, and portable tanks that were filled during a single shift
- (3) Containers, intermediate bulk containers, and portable tanks needed to supply the process for one continuous 24-hour period
- (4) Containers, intermediate bulk containers, and portable tanks that are stored in accordance with Chapter 9

**18.4.9** Class I, Class II, or Class IIIA liquids used in a process and staged in the process area shall not be filled in the process area.

*Exception No. 1: Intermediate bulk containers and portable tanks that meet the requirements of Chapter 9.*

*Exception No. 2: Intermediate products that are manufactured in the process area.*

## 18.5 Incidental Operations.

**18.5.1\*** This section shall apply to areas where the use, handling, and storage of liquids is only a limited activity to the established occupancy classification.

**18.5.2** Class I liquids or Class II and Class III liquids that are heated up to or above their flash points shall be drawn from or transferred into vessels, containers, or portable tanks as follows:

- (1) From original shipping containers with a capacity of 5.3 gal (20 L) or less
- (2) From safety cans
- (3) Through a closed piping system
- (4) From portable tanks or containers by means of a device that has antisiphoning protection and that draws through an opening in the top of the tank or container
- (5) By gravity through a listed self-closing valve or self-closing faucet

**18.5.2.1** If hose is used in the transfer operation, it shall be equipped with a self-closing valve without a hold-open latch in addition to the outlet valve. Only listed or approved hose shall be used.

**18.5.2.2** Means shall be provided to minimize generation of static electricity. Such means shall meet the requirements of 6.5.4.

**18.5.2.3** Where pumps are used for liquid transfer, means shall be provided to deactivate liquid transfer in the event of a liquid spill or fire.

**18.5.3** Storage of liquids other than those governed by 18.5.4 and 18.5.5 shall comply with Chapter 9.

**18.5.4** The quantity of liquid located outside of identified storage areas, such as storage cabinets, other inside liquid storage areas, general-purpose warehouses, or other specific processing

areas that are cut off from the general plant area by at least a 2-hour fire separation, shall meet the requirements of 18.5.4.1.

**18.5.4.1** The maximum quantity of liquids permitted for incidental operations in a single fire area shall not exceed the greater of the following:

- (1)\*The amount required to supply incidental operations for one continuous 24-hour period
- (2) The aggregate sum of the following:
  - (a) 25 gal (95 L) of Class IA liquids in containers
  - (b) 120 gal (454 L) of Class IB, Class IC, Class II, or Class III liquids in containers
  - (c) 1585 gal (6000 L) of any combination of the following:
    - i. Class IB, IC, II, or IIIA liquids in metal portable tanks or metal intermediate bulk containers, each not exceeding 793 gal (3000 L)
    - ii. Class II or Class IIIA liquids in nonmetallic intermediate bulk containers, each not exceeding 793 gal (3000 L)
  - (d) 20 portable tanks or intermediate bulk containers each not exceeding 793 gal (3000 L) of Class IIIB liquids

**18.5.5** Where quantities of liquids in excess of the limits in 18.5.4.1 are necessary, storage shall be in tanks that meet all applicable requirements of Chapter 17, Chapters 21 through 25, and Chapter 27.

**18.5.6** Areas in which liquids are transferred from one tank or container to another container shall be provided with the following:

- (1) Separation from other operations where potential ignition sources are present by distance or by fire-resistant construction
- (2) Drainage or other means to control spills
- (3)\*Natural or mechanical ventilation that meets the requirements of Section 17.11

**18.6 Ventilation for Dispensing Areas.** Liquid storage areas where dispensing is conducted shall be provided with either a gravity system or a continuous mechanical exhaust ventilation system. Mechanical ventilation shall be used if Class I liquids are dispensed within the room.

**18.6.1** Exhaust air shall be taken from a point near a wall on one side of the room and within 12 in. (300 mm) of the floor, with one or more make-up inlets located on the opposite side of the room within 12 in. (300 mm) of the floor.

**18.6.2** The location of both the exhaust and inlet air openings shall be arranged to provide air movement across all portions of the floor to prevent accumulation of flammable vapors.

**18.6.3\*** Exhaust ventilation discharge shall be to a safe location outside the building.

**18.6.3.1** Recirculation of the exhaust air shall be permitted only when it is monitored continuously using a fail-safe system that is designed to automatically sound an alarm, stop recirculation, and provide full exhaust to the outside in the event that vapor-air mixtures in concentrations over one-fourth of the lower flammable limit are detected.

**18.6.4** If ducts are used, they shall not be used for any other purpose and shall comply with NFPA 91, *Standard for Exhaust Systems for Air Conveying of Vapors, Gases, Mists, and Noncombustible Particulate Solids*.



**18.6.4.1** If make-up air to a mechanical system is taken from within the building, the opening shall be equipped with a fire door or damper, as required in NFPA 91, *Standard for Exhaust Systems for Air Conveying of Vapors, Gases, Mists, and Noncombustible Particulate Solids*.

**18.6.4.2** For gravity systems, the make-up air shall be supplied from outside the building.

**18.6.5** Mechanical ventilation systems shall provide at least 1 cfm of exhaust air for each square foot of floor area ( $0.3 \text{ m}^3/\text{min}/\text{m}^2$ ), but not less than 150 cfm ( $4 \text{ m}^3/\text{min}$ ).

**18.6.5.1** The mechanical ventilation system for dispensing areas shall be equipped with an airflow switch or other equally reliable method that is interlocked to sound an audible alarm upon failure of the ventilation system.

## Chapter 19 Specific Operations

**19.1 Scope.** This chapter shall apply to the handling and use of flammable and combustible liquids in specific operations as herein described.

### 19.2 Definitions Specific to Chapter 19.

**19.2.1\* Cooking Oil.** Where used in this chapter, cooking oil shall be classified as a Class IIIB combustible liquid. This definition shall apply to both fresh, or new, cooking oil and waste, or used, cooking oil.

### 19.3 General Requirements. (Reserved)

### 19.4 Recirculating Heat Transfer Systems.

#### 19.4.1 Scope.

**19.4.1.1** This section shall apply only to recirculating heat transfer systems that use a heat transfer fluid that is heated up to or above its flash point under normal operation.

**19.4.1.2** This section shall not apply to process streams used as a means of heat transfer or to any heat transfer system of 60 gal (230 L) capacity or less.

**19.4.2\* General Requirements.** A heater or vaporizer for heat transfer fluid that is located inside a building shall meet all applicable requirements of Chapter 17.

#### 19.4.3\* System Design.

**19.4.3.1\*** Drainage shall be provided at strategic low points in the heat transfer system. Drains shall be piped to a safe location that is capable of accommodating the total capacity of the system or the capacity of that part of the system that is isolated.

**19.4.3.2\*** Where the heat transfer system expansion tank is located above floor level and has a capacity of more than 250 gal (950 L), it shall be provided with a low-point drain line that can allow the expansion tank to drain to a drain tank on a lower level. The drain line valve shall be operable from a safe location.

**19.4.3.3** A heat transfer fluid system shall not be used to provide direct building heat.

**19.4.3.4** All pressure-relief device outlets shall be piped to a safe location.

**19.4.4\* Fuel Burner Controls and Interlocks.** Oil- or gas-fired heaters or vaporizers shall be designed and installed in accordance with the applicable requirements of NFPA 31, *Standard for the Installation of Oil-Burning Equipment*, or NFPA 85, *Boiler and*

*Combustion Systems Hazards Code*, whichever is applicable. Wood dust suspension-fired heaters or vaporizers shall be designed and installed in accordance with the applicable requirements of NFPA 85.

### 19.4.5 Piping.

**19.4.5.1\*** Piping shall meet all applicable requirements of Chapter 27.

**19.4.5.2** All pipe connections shall be welded.

**19.4.5.2.1** Welded, threaded connections shall be permitted to be used for piping 2 in. (50 mm) and smaller.

**19.4.5.2.2** Mechanical joints shall be permitted to be used at pump, valve, and equipment connections.

**19.4.5.3** New piping that is to be insulated with permanent insulation and existing piping that has been disturbed and is to be reinsulated with permanent insulation shall be covered with a closed-cell, nonabsorbent insulation material.

**19.4.5.3.1** Where all pipe joints are welded and where there are no other points in the system subject to leakage, such as at valves or pumps, other types of insulation shall be permitted.

**19.4.5.3.2** Where dams are formed around possible leak-producing areas, using metal “donut” flanges that are welded to the pipe or using a “donut” segment of nonabsorbent insulation sealed to the pipe to prevent migration of leakage into adjacent insulation, the piping from dam to dam shall be considered to be a closed system and other types of insulation shall be permitted. The area subject to leakage where the dam has been constructed shall be insulated with nonabsorbent insulation or a nonabsorbent insulation system.

**19.4.5.3.3** Where removable, reusable insulated covers are required for access, the covers shall be fabricated of flexible or rigid insulation that is encapsulated in a manner to provide a nonabsorbent insulation system to prevent absorption of leakage into the insulation.

### 19.4.6 Fire Protection.

**19.4.6.1\*** Automatic sprinkler protection meeting the requirements of NFPA 13, *Standard for the Installation of Sprinkler Systems*, for Extra Hazard (Group I) Occupancies shall be provided for building areas containing a heat transfer system heater or vaporizer.

**19.4.6.2** An alternate fire protection system shall be permitted to be used, if approved by the authority having jurisdiction. Such alternate system shall be designed and installed in accordance with the appropriate NFPA standard and with manufacturer’s recommendations for the system selected.

### 19.4.7 Operation.

**19.4.7.1\*** Operations involving heat transfer fluid systems and equipment shall be reviewed to ensure that the fire and explosion hazards resulting from loss of containment of the fluid or failure of the system are provided with corresponding fire prevention and emergency action plans.

**19.4.7.2** Operators of heat transfer systems shall be trained in the hazards of improper operation of the system and leakage and shall be trained to recognize upset conditions that can lead to dangerous situations.

**19.4.7.3** Safety interlocks shall be inspected, calibrated, and tested annually or at other intervals established in accordance with other applicable standards to determine that they are in proper operating condition.

## 19.5 Vapor Recovery and Vapor Processing Systems.

### 19.5.1 Scope.

**19.5.1.1** This section shall apply to vapor recovery and vapor processing systems where the vapor source operates at pressures from vacuum up to and including a gauge pressure of 1.0 psi (6.9 kPa), or where there is a potential for vapor mixtures in the flammable range.

**19.5.1.2** This section shall not apply to the following:

- (1) Marine systems that comply with U.S. Department of Transportation Regulations in Title 33, Code of Federal Regulations, Parts 154, 155, and 156, and U.S. Coast Guard Regulations in Title 46, Code of Federal Regulations, Parts 30, 32, 35, and 39
- (2) Marine and automotive service station systems that comply with NFPA 30A, *Code for Motor Fuel Dispensing Facilities and Repair Garages*

**19.5.2 Overpressure Protection and Vacuum Protection.** Tanks and equipment shall have independent venting for overpressure or vacuum conditions that could occur from malfunction of the vapor recovery or vapor processing system.

*Exception: For tanks, venting shall comply with 21.4.3.*

### 19.5.3 Vent Location.

**19.5.3.1** Vents on vapor processing systems shall be not less than 12 ft (3.7 m) from adjacent ground level, with outlets located and directed so that ignitable vapors will disperse to a concentration below the lower flammable limit before reaching any location that contains an ignition source.

**19.5.3.2** Vent outlets shall be located so that vapors will not be trapped by eaves or other obstructions and shall be at least 5 ft (1.5 m) from building openings and at least 15 ft (4.5 m) from powered ventilation air intake devices.

**19.5.3.3** Vapor processing equipment and their vents shall be located in accordance with Section 17.3.

### 19.5.4 Vapor Collection Systems.

**19.5.4.1** Vapor collection piping shall be designed to prevent trapping liquid.

**19.5.4.2** Vapor recovery and vapor processing systems that are not designed to handle liquid shall be provided with a means to eliminate any liquid that carries over to or condenses in the vapor collection system.

### 19.5.5 Liquid Level Monitoring.

**19.5.5.1\*** A liquid knock-out vessel used in the vapor collection system shall have means to verify the liquid level and a high liquid level sensor that activates an alarm.

**19.5.5.2** For unattended facilities, the high liquid level sensor shall initiate shutdown of liquid transfer into the vessel and shutdown of vapor recovery or vapor processing systems.

### 19.5.6 Overfill Protection.

**19.5.6.1** Storage tanks served by vapor processing or vapor recovery systems shall be equipped with overfill protection in accordance with 21.7.1.

**19.5.6.2** Overfill protection of tank vehicles shall be in accordance with applicable provisions of 28.11.1.

### 19.5.7 Sources of Ignition.

**19.5.7.1 Vapor Release.** Tank or equipment openings provided for purposes of vapor recovery shall be protected against possible vapor release in accordance with 23.13.7 and 28.11.1.8.1.

**19.5.7.2\* Electrical Area Classification.** Electrical area classification shall be in accordance with Chapter 7.

**19.5.7.3\* Static Electricity.** Vapor collection and vapor processing equipment shall be protected against static electricity in accordance with 6.5.4.

**19.5.7.4\* Spontaneous Ignition.** Equipment shall be designed or written procedures established and implemented to prevent ignition where the potential exists for spontaneous ignition.

**19.5.7.5\* Friction Heat or Sparks from Mechanical Equipment.** Mechanical equipment used to move vapors that are in the flammable range shall be designed to prevent sparks or other ignition sources under both normal and equipment malfunction conditions.

**19.5.7.6\* Flame Propagation.** Where there is reasonable potential for ignition of a vapor mixture in the flammable range, means shall be provided to stop the propagation of flame through the vapor collection system. The means chosen shall prevent flame propagation under the conditions with which they will be used.

**19.5.7.7 Explosion Protection.** Where used, explosion protection systems shall comply with NFPA 69, *Standard on Explosion Prevention Systems*.

**19.5.8 Emergency Shutdown Systems.** Emergency shutdown systems shall be designed to fail to a safe position in the event of loss of normal system power (i.e., air or electric) or equipment malfunction.

## 19.6 Solvent Distillation Units.

### 19.6.1 Scope.

**19.6.1.1** This section shall apply to solvent distillation units having distillation chambers or still pots that do not exceed 60 gal (227 L) nominal capacity and are used to recycle Class I, Class II, or Class IIIA liquids.

**19.6.1.2** This section shall not apply to research, testing, or experimental processes; to distillation processes carried out in petroleum refineries, chemical plants, or distilleries; or to distillation equipment used in dry cleaning operations.

**19.6.2 Equipment.** Solvent distillation units shall be approved or shall be listed in accordance with ANSI/UL 2208, *Standard for Solvent Distillation Units*.

**19.6.3 Solvents.** Solvent distillation units shall only be used to distill liquids for which they have been investigated and that are listed on the unit's marking or contained within the manufacturer's literature.

**19.6.3.1** Unstable or reactive liquids or materials shall not be processed unless they have been specifically listed on the system's markings or contained within the manufacturer's literature.

### 19.6.4 Location.

**19.6.4.1** Solvent distillation units shall be located and operated in locations in accordance with their approval or listing.

**19.6.4.2** Solvent distillation units shall not be used in basements.



**19.6.4.3** Solvent distillation units shall be located away from potential sources of ignition, as indicated on the unit's marking.

**19.6.5 Liquid Storage.** Distilled liquids and liquids awaiting distillation shall be stored in accordance with this code.

### **19.7 Cooking Oil Storage Tank Systems in Commercial Kitchens.**

#### **19.7.1 Scope.**

**19.7.1.1** This section shall apply to storage tank systems for cooking oil, as defined in 19.2.1, located in commercial kitchens where tank capacities are greater than 60 gal (227 L).

**19.7.1.2** This section shall apply to both fresh and waste cooking oil storage tank systems.

**19.7.1.3\*** Where there are conflicts between the requirements of this section and requirements of other sections of this code, the requirements of this section shall take precedence.

#### **19.7.2 Design and Construction of Cooking Oil Storage Tanks.**

**19.7.2.1 Materials of Construction.** Tanks shall be of metallic or nonmetallic construction.

**19.7.2.1.1** Tanks and their appurtenances shall be constructed of materials compatible with cooking oil.

**19.7.2.1.2\*** For tanks storing waste cooking oil, the tanks and their appurtenances shall be constructed of materials compatible with cooking oil at a minimum temperature of 140°F (60°C) continuous and 235°F (113°C) intermittent.

#### **19.7.2.2 Design Standards.**

**19.7.2.2.1\*** Metallic cooking oil storage tanks shall be listed in accordance with ANSI/UL 142, *Standard for Steel Aboveground Tanks for Flammable and Combustible Liquids*, or ANSI/UL 80, *Standard for Steel Tanks for Oil-Burner Fuels and Other Combustible Liquids*.

**19.7.2.2.2** Nonmetallic cooking oil storage tanks shall meet the following requirements:

- (1) Tanks shall be listed for use with cooking oil, unless otherwise approved.
- (2) Tanks shall not exceed 200 gal (757 L) per tank.

#### **19.7.2.3 Normal Venting.**

**19.7.2.3.1** The normal vent(s) shall be located above the maximum normal liquid level.

**19.7.2.3.2** The normal vent shall be at least as large as the largest filling or withdrawal connection.

**19.7.2.3.3** Where used, normal vents, including vent piping, that are smaller than 1.25 in. (32 mm) nominal inside diameter shall be tested to verify that internal tank pressures will remain below a gauge pressure of 0.5 psi (3.5 kPa) under maximum expected flow rates for tank filling and withdrawal. These tests shall be permitted to be conducted by a qualified outside agency or by the manufacturer, if certified by a qualified observer.

**19.7.2.3.4\*** Normal vents shall be permitted to discharge inside the building.

#### **19.7.2.4 Emergency Venting.**

**19.7.2.4.1** Cooking oil storage tanks shall be provided with emergency relief venting in accordance with Chapter 22.

**19.7.2.4.2\*** For nonmetallic cooking oil storage tanks, emergency relief venting by form of construction shall be permitted. This shall include the low melting point of the material of construction of the tank.

**19.7.2.4.3** For metallic cooking oil storage tanks, emergency relief venting by form of construction shall be prohibited.

**19.7.2.4.4** Emergency vents shall be permitted to discharge inside the building.

**19.7.2.5\* Prevention of Overfilling of Cooking Oil Storage Tanks.** Every cooking oil storage tank shall be provided with means to prevent an accidental overfill. Such means shall be automatic and fail-safe in nature.

#### **19.7.2.6 Tank Heating.**

**19.7.2.6.1\*** Electrical equipment used for heating cooking oil shall be listed to ANSI/UL 499, *Standard for Electrical Heating Appliances*, and shall comply with *NFPA 70, National Electrical Code*.

**19.7.2.6.2\*** Electrical equipment used for heating cooking oil shall comply with *NFPA 70, National Electrical Code*, and shall be equipped with automatic means to limit the temperature of the oil to less than 140°F (60°C).

**19.7.2.6.3** Use of electrical immersion heaters in nonmetallic tanks shall be prohibited.

#### **19.7.3 Tank Installation and Testing.**

**19.7.3.1 Location of Cooking Oil Storage Tanks.** Tanks shall be installed in locations appropriate for storage of foodstuffs or inventory and shall not be installed in areas designated as cooking areas.

**19.7.3.1.1\*** Tanks shall be spaced at least 3 ft (0.9 m) away from any cooking appliance or any surface heated to a temperature above 140°F (60°C) continuous and at least 6 ft (1.8 m) away from any open flame.

**19.7.3.1.2\*** Tanks shall not be installed under commercial kitchen ventilation hoods.

**19.7.3.1.3** Tanks shall not be required to be separated from one another.

#### **19.7.3.2 Foundations for and Anchoring of Cooking Oil Storage Tanks.**

**19.7.3.2.1** Tank supports shall be secured to the tank and to the floor to prevent the tank from tipping over. For a flat-bottom tank resting directly on the floor, the tank shall be secured to the floor to prevent the tank from tipping over.

**19.7.3.2.2** In areas subject to earthquakes, tank supports, the foundation, and anchoring shall meet the requirements of the applicable building code for the specific seismic zone. Engineering evaluation by a qualified, impartial outside agency shall be an acceptable method of meeting this requirement.

**19.7.3.2.3** Where a tank is located in areas subject to flooding, the method for anchoring the tank to the floor shall be capable of preventing the tank, either full or empty, from floating during a rise in water level up to the established maximum flood stage. Engineering evaluation by a qualified, impartial outside agency shall be an acceptable method of meeting this requirement.

#### **19.7.3.3 Tank Openings Other than Vents.**

**19.7.3.3.1** Each connection to the tank below the normal liquid level through which liquid can normally flow shall be provided



with an internal or external valve located as close as possible to the shell of the tank, in accordance with Chapter 22.

**19.7.3.3.2\*** Connections to the tank above the normal liquid level through which liquid can normally flow shall not be required to have a valve, provided there exists a liquidtight closure at the opposite end of the line. The liquidtight closure shall be in the form of a valve, a plug, or a coupling or fitting with positive shutoff.

#### 19.7.3.4 Field Testing.

**19.7.3.4.1\*** As an alternate method to the testing requirements in Chapter 21, cooking oil storage tanks shall be tested for leaks at the time of installation by filling the tank with cooking oil to a liquid level above the highest tank seam or connection within the normal liquid level. Before the tank is placed in service, all leaks shall be corrected in an approved manner or the tank shall be replaced.

**19.7.3.4.2** An approved listing mark on a cooking oil storage tank shall be considered to be evidence of compliance with tank testing requirements.

#### 19.7.4 Fire Protection for Cooking Oil Storage Tanks.

**19.7.4.1 Identification for Emergency Responders.** A sign or marking that meets the requirements of NFPA 704, *Standard System for the Identification of the Hazards of Materials for Emergency Response*, or another approved system, shall be applied to each cooking oil storage tank in accordance with Chapter 21. Additional signage shall be applied to each tank identifying the contents of the tank as cooking oil, either fresh or waste.

**19.7.4.2\*** In areas where tanks are located, no additional ventilation shall be required beyond that necessary for comfort ventilation, provided that all cooking equipment is equipped with exhaust systems in accordance with NFPA 96, *Standard for Ventilation Control and Fire Protection of Commercial Cooking Operations*.

**19.7.4.3** If ventilation is not provided as specified in 19.7.4.2, then the tank shall be vented to another room inside the building that meets these requirements, or the tank shall be vented to the outside of the building.

#### 19.7.5 Transfer Lines.

**19.7.5.1\* Design and Construction of Fresh Cooking Oil Transfer Lines.** Transfer lines for fresh cooking oil shall be permitted to be constructed of metallic or nonmetallic materials that are compatible with cooking oil and food products. Nonmetallic transfer lines shall also meet the following requirements:

- (1) Transfer lines in pressure applications shall be rated for a working gauge pressure of 100 psi (689 kPa) at 70°F (21°C) or the maximum output pressure of the transfer pump, whichever is higher.
- (2) Transfer lines in suction applications shall be rated for full vacuum at 70°F (21°C).
- (3) Transfer lines shall be rated for temperatures up to 120°F (49°C) continuous.
- (4) The maximum nominal inside diameter shall be no larger than 1.25 in. (32 mm).
- (5) Leakage shall be controlled through the use of check valves or antisiphon valves at points where the lines connect to the fresh oil tank.

**19.7.5.2\* Design and Construction of Waste Cooking Oil Transfer Lines.** Waste cooking oil transfer lines shall be permitted to be constructed of metallic or nonmetallic materials that are compatible with cooking oil.

**19.7.5.2.1** Transfer lines shall be rated for use with cooking oil at elevated temperatures of 275°F (135°C) continuous and 350°F (177°C) intermittent.

**19.7.5.2.2** Nonmetallic transfer lines shall be rated for working pressures up to 250 psi (1724 kPa) at 275°F (135°C).

**19.7.5.3 Flow Control.** Cooking oil transfer lines shall be equipped with means to prevent unintended transfer or dispensing of cooking oil. These means shall be permitted to be in the form of momentary control switches, valves, check valves, antisiphon valves, plugs, couplings, fittings, or any combination thereof that are fail-safe in nature.

**19.7.5.4 Pressure Control.** Pumping systems used to transfer cooking oil shall have means to prevent overpressurization of transfer lines. These means shall be in the form of relief valves, bypass valves, pressure sensor devices, or the pressure limitation of the pump itself.

**19.7.5.5 Installation of Cooking Oil Transfer Lines in Plenum-Rated Spaces.** Cooking oil transfer lines installed in plenum-rated spaces shall be enclosed in noncombustible raceways or enclosures, or shall be covered with a material listed and labeled for installation within a plenum.

**19.7.5.6 Testing of Cooking Oil Transfer Lines.** Cooking oil transfer lines shall be tested after installation and prior to use. Testing shall be with cooking oil at the normal operating pressures. Any leaks discovered in transfer lines as a result of testing shall be repaired or the transfer lines replaced prior to placing the transfer lines into service.

## Chapter 20 Reserved

## Chapter 21 Storage of Liquids in Tanks — Requirements for All Storage Tanks

**21.1 Scope.** This chapter shall apply to the following:

- (1) The storage of flammable and combustible liquids, as defined in 3.3.33 and Chapter 4, in fixed tanks that exceed 60 gal (230 L) capacity
- (2) The storage of flammable and combustible liquids in portable tanks that exceed 660 gal (2500 L) capacity
- (3) The storage of flammable and combustible liquids in intermediate bulk containers that exceed 793 gal (3000 L) capacity
- (4) The design, installation, testing, operation, and maintenance of such tanks, portable tanks, and bulk containers

**21.2 Definitions Specific to Chapter 21.** For the purpose of this chapter, the term in this section shall have the definitions given.

**21.2.1 Compartmented Tank.** A tank that is divided into two or more compartments intended to contain the same or different liquids.

#### 21.3 General Requirements.

**21.3.1** Storage of Class II and Class III liquids heated at or above their flash point shall follow the requirements for Class I liquids, unless an engineering evaluation conducted in accordance with Chapter 6 and Section 21.6 justifies following the requirements for some other liquid class.



**21.3.2** Tanks shall be permitted to be of any shape, size, or type consistent with recognized engineering standards. Metal tanks shall be welded, riveted and caulked, or bolted or constructed using a combination of these methods.

**21.3.3** Tanks designed and intended for aboveground use shall not be used as underground tanks.

**21.3.4** Tanks designed and intended for underground use shall not be used as aboveground tanks.

**21.3.5** Tanks shall be designed and built in accordance with recognized engineering standards for the material of construction being used.

## 21.4 Design and Construction of Storage Tanks.

**21.4.1 Materials of Construction.** Tanks shall be of steel or other approved noncombustible material and shall meet the applicable requirements of 21.4.1.1 through 21.4.1.5.

**21.4.1.1** The materials of construction for tanks and their appurtenances shall be compatible with the liquid to be stored. In case of doubt about the properties of the liquid to be stored, the supplier, producer of the liquid, or other competent authority shall be consulted.

**21.4.1.2** Tanks shall be permitted to be constructed of combustible materials when approved. Tanks constructed of combustible materials shall be limited to any of the following:

- (1) Underground installation
- (2) Use where required by the properties of the liquid stored
- (3) Aboveground storage of Class IIIB liquids in areas not exposed to a spill or leak of Class I or Class II liquid
- (4) Storage of Class IIIB liquids inside a building protected by an approved automatic fire-extinguishing system

**21.4.1.3** Unlined concrete tanks shall be permitted to be used for storing liquids that have a gravity of 40° API or heavier. Concrete tanks with special linings shall be permitted to be used for other liquids, provided they are designed and constructed in accordance with recognized engineering standards.

**21.4.1.4** Tanks shall be permitted to have combustible or noncombustible linings. The selection, specification, and type of lining material and its required thickness shall be based on the properties of the liquid to be stored. When there is a change in the characteristics of the liquid to be stored, the compatibility of the lining and the liquid shall be verified.

**21.4.1.5** An engineering evaluation shall be made if the specific gravity of the liquid to be stored exceeds that of water or if the tank is designed to contain liquids at a liquid temperature below 0°F (−18°C).

## 21.4.2 Design Standards for Storage Tanks.

### 21.4.2.1 Design Standards for Atmospheric Tanks.

**21.4.2.1.1\*** Atmospheric tanks shall be designed and constructed in accordance with recognized engineering standards. Atmospheric tanks that meet any of the following standards shall be deemed as meeting the requirements of 21.4.2.1:

- (1) API Specification 12B, *Bolted Tanks for Storage of Production Liquids*
- (2) API Specification 12D, *Field Welded Tanks for Storage of Production Liquids*
- (3) API Specification 12F, *Shop Welded Tanks for Storage of Production Liquids*
- (4) API Standard 650, *Welded Steel Tanks for Oil Storage*

- (5) UL 58, *Standard for Steel Underground Tanks for Flammable and Combustible Liquids*
- (6) ANSI/UL 80, *Standard for Steel Tanks for Oil-Burner Fuels and Other Combustible Liquids*
- (7) ANSI/UL 142, *Standard for Steel Aboveground Tanks for Flammable and Combustible Liquids*
- (8) UL 1316, *Standard for Glass-Fiber Reinforced Plastic Underground Storage Tanks for Petroleum Products, Alcohols, and Alcohol-Gasoline Mixtures*
- (9) ANSI/UL 1746, *Standard for External Corrosion Protection Systems for Steel Underground Storage Tanks*
- (10) UL 2080, *Standard for Fire Resistant Tanks for Flammable and Combustible Liquids*
- (11) ANSI/UL 2085, *Standard for Protected Aboveground Tanks for Flammable and Combustible Liquids*

**21.4.2.1.2** Except as provided for in 21.4.2.1.3 and 21.4.2.1.4, atmospheric tanks designed and constructed in accordance with Appendix F of API Standard 650, *Welded Steel Tanks for Oil Storage*, shall be permitted to operate at pressures from atmospheric to a gauge pressure of 1.0 psi (6.9 kPa). All other tanks shall be limited to operation from atmospheric to a gauge pressure of 0.5 psi (3.5 kPa).

**21.4.2.1.3** Atmospheric tanks that are not designed and constructed in accordance with Appendix F of API Standard 650, *Welded Steel Tanks for Oil Storage*, shall be permitted to operate at pressures from atmospheric to a gauge pressure of 1.0 psi (6.9 kPa) only if an engineering analysis is performed to determine that the tank can withstand the elevated pressure.

**21.4.2.1.4** Horizontal cylindrical and rectangular tanks built according to any of the standards specified in 21.4.2.1.1 shall be permitted to operate at pressures from atmospheric to a gauge pressure of 1.0 psi (6.9 kPa) and shall be limited to a gauge pressure of 2.5 psi (17 kPa) under emergency venting conditions.

**21.4.2.1.5** Low-pressure tanks and pressure vessels shall be permitted to be used as atmospheric tanks.

**21.4.2.1.6** Atmospheric tanks shall not be used to store a liquid at a temperature at or above its boiling point.

### 21.4.2.2 Design Standards for Low-Pressure Tanks.

**21.4.2.2.1** Low-pressure tanks shall be designed and constructed in accordance with recognized engineering standards. Low-pressure tanks that meet either of the following standards shall be deemed as meeting the requirements of 21.4.2.2:

- (1) API 620, *Recommended Rules for the Design and Construction of Large, Welded, Low-Pressure Storage Tanks*
- (2) ASME Code for Unfired Pressure Vessels, Section VIII, Division 1

**21.4.2.2.2** Low-pressure tanks shall not be operated above their design pressures.

**21.4.2.2.3** Pressure vessels shall be permitted to be used as low-pressure tanks.

### 21.4.2.3 Design Standards for Pressure Vessels.

**21.4.2.3.1** Tanks with storage pressures above a gauge pressure of 15 psi (100 kPa) shall be designed and constructed in accordance with recognized engineering standards. Pressure vessels that meet any of the following standards shall be deemed as meeting the requirements of 21.4.2.3:

- (1) Fired pressure vessels shall be designed and constructed in accordance with Section I (Power Boilers), or Section VIII,

Division 1 or Division 2 (Pressure Vessels), as applicable, of the ASME *Boiler and Pressure Vessel Code*.

- (2) Unfired pressure vessels shall be designed and constructed in accordance with Section VIII, Division 1 or Division 2, of the ASME *Boiler and Pressure Vessel Code*.

**21.4.2.3.2\*** Pressure vessels that do not meet the requirements of 21.4.2.3.1(1) or 21.4.2.3.1(2) shall be permitted to be used, provided they are approved by the authority having jurisdiction.

**21.4.2.3.3** Pressure vessels shall not be operated above their design pressures. The normal operating pressure of the vessel shall not exceed the design pressure of the vessel.

#### **21.4.3 Normal Venting for Storage Tanks.**

**21.4.3.1** Storage tanks shall be vented to prevent the development of vacuum or pressure that can distort the tank or exceed the rated design pressure of the tank when the tank is filled or emptied or because of atmospheric temperature changes. Normal vents shall be located above the maximum normal liquid level.

**21.4.3.2\*** Normal venting shall be provided for primary tanks and each primary compartment of a compartmented tank.

**21.4.3.3** Normal vents shall be sized in accordance with either API Standard 2000, *Venting Atmospheric and Low-Pressure Storage Tanks*, or another approved standard. Alternatively, the normal vent shall be at least as large as the largest filling or withdrawal connection, but in no case shall it be less than 1.25 in. (32 mm) nominal inside diameter.

**21.4.3.4** Atmospheric storage tanks shall be vented to prevent the development of vacuum or pressure above the 1.0 psi (6.9 kPa) maximum operating pressure.

**21.4.3.5** Low-pressure tanks and pressure vessels shall be vented to prevent the development of pressure or vacuum that exceeds the rated design pressure of the tank or vessel. Means shall also be provided to prevent overpressure from any pump discharging into the tank or vessel when the pump discharge pressure can exceed the design pressure of the tank or vessel.

**21.4.3.6** If any tank or pressure vessel has more than one fill or withdrawal connection and simultaneous filling or withdrawal can be made, the vent size shall be based on the maximum anticipated simultaneous flow.

**21.4.3.7** For tanks equipped with vents that permit pressures to exceed a gauge pressure of 2.5 psi (17 kPa) and for low-pressure tanks and pressure vessels, the outlet of all vents and vent drains shall be arranged to discharge in a manner that prevents localized overheating of or flame impingement on any part of the tank, if vapors from the vents are ignited.

**21.4.3.8** Tanks and pressure vessels that store Class IA liquids shall be equipped with venting devices that are closed, except when venting under pressure or vacuum conditions.

**21.4.3.9** Tanks and pressure vessels that store Class IB and Class IC liquids shall be equipped with venting devices or with listed flame arresters. When used, vent devices shall be closed, except when venting under pressure or vacuum conditions.

**21.4.3.10** Tanks of 3000 barrels (bbl) [126,000 gal (475 m<sup>3</sup>)] capacity or less that store crude petroleum in crude-producing areas and outside aboveground atmospheric tanks of less than 1000 gal (3785 L) capacity that contain other than Class IA liquids shall be permitted to have open vents.

**21.4.3.11\*** Flame arresters or venting devices required in 21.4.3.8 and 21.4.3.9 shall be permitted to be omitted on tanks that store Class IB or Class IC liquids where conditions are such that their use can, in case of obstruction, result in damage to the tank.

**21.4.3.12** Piping for normal vents shall be designed in accordance with Chapter 27.

**21.4.4\* Tank Fill Pipes.** Fill pipes that enter the top of a tank shall terminate within 6 in. (150 mm) of the bottom of the tank. Fill pipes shall be installed or arranged so that vibration is minimized.

*Exception No. 1: Fill pipes in tanks whose vapor space under the expected range of operating conditions is not in the flammable range or is inerted need not meet this requirement.*

*Exception No. 2: Fill pipes in tanks handling liquids with minimal potential for accumulation of static charge need not meet this requirement, provided that the fill line is designed and the system is operated to avoid mist generation and to provide residence time downstream of filters or screens to allow dissipation of the generated static charge.*

#### **21.4.5\* Corrosion Protection.**

**21.4.5.1** Corrosion protection shall meet the requirements of 21.4.5.2 or 21.4.5.3, whichever is applicable.

**21.4.5.2 Internal Corrosion Protection for Metal Storage Tanks.** Where tanks are not designed in accordance with standards of the American Petroleum Institute, the American Society of Mechanical Engineers, or Underwriters Laboratories Inc., or if corrosion is anticipated beyond that provided for in the design formulas or standards used, additional metal thickness or approved protective coatings or linings shall be provided to compensate for the corrosion loss expected during the design life of the tank.

**21.4.5.3 Internal Corrosion Protection for Nonmetallic Tanks.** Where tanks are not designed in accordance with standards of the American Petroleum Institute, the American Society of Mechanical Engineers, ASTM International, or Underwriters Laboratories Inc., or if degradation is anticipated beyond that provided for in the design formulas or standards used, degradation shall be compensated for by providing additional tank material thickness or by application of protective coatings or linings, as determined by an engineering analysis.

#### **21.5 Testing Requirements for Tanks.**

**21.5.1 General.** All tanks, whether shop-built or field-erected, shall be tested before they are placed in service in accordance with the requirements of the code under which they were built.

**21.5.1.1** An approved listing mark on a tank shall be considered to be evidence of compliance with 21.5.1. Tanks not so marked shall be tested before they are placed in service in accordance with the applicable requirements for testing in the standards listed in 21.4.2.1.1, 21.4.2.2.1, or 21.4.2.3.1, or in accordance with recognized engineering standards. Upon satisfactory completion of testing, a permanent record of the test results shall be maintained by the owner.

**21.5.1.2** Where the vertical length of the fill and vent pipes is such that, when filled with liquid, the static head imposed on the bottom of the tank exceeds a gauge pressure of 10 psi (70 kPa), the tank and its related piping shall be tested hydrostatically to a pressure equal to the static head thus imposed by using recognized engineering standards.



**21.5.1.3** Before the tank is initially placed in service, all leaks or deformations shall be corrected in an approved manner. Mechanical caulking shall not be permitted for correcting leaks in welded tanks except for pinhole leaks in the roof.

**21.5.1.4** Tanks to be operated at pressures below their design pressure shall be tested by the applicable provisions of 21.5.1.1 or 21.5.1.2 based upon the pressure developed under full emergency venting of the tank.

**21.5.2\* Tightness Testing.** In addition to the tests called for in 21.5.1, all tanks and connections shall be tested for tightness after installation and before being placed in service in accordance with 21.5.2.2 through 21.5.2.8, as applicable. Except for underground tanks, this test shall be made at operating pressure with air, inert gas, or water.

**21.5.2.1** Testing required by 21.5.2 shall not be required for a primary tank or an interstitial space that continues to maintain a factory-applied vacuum in accordance with the manufacturer's instructions. Such components shall be considered to be tight until such time that the vacuum is broken. Final tightness testing of an interstitial space shall not be required if the factory-applied vacuum is maintained until one of the following conditions is met:

- (1) For aboveground tanks, the tank is set on the site at the location where it is intended to be installed.
- (2) For underground tanks, backfill has been completed to the top of the tank.

**21.5.2.2** Air pressure shall not be used to test tanks that contain flammable or combustible liquids or vapors. (See Section 27.7 for testing pressure piping.)

**21.5.2.3** For field-erected tanks, the tests required by 21.5.1.1 or 21.5.1.2 shall be permitted to be considered the test for tank tightness.

**21.5.2.4** Horizontal shop-fabricated aboveground tanks shall be tested for tightness either hydrostatically or with air pressure at not less than a gauge pressure of 3 psi (20 kPa) and not more than a gauge pressure of 5 psi (35 kPa).

**21.5.2.5** Vertical shop-fabricated aboveground tanks shall be tested for tightness either hydrostatically or with air pressure at not less than a gauge pressure of 1.5 psi (10 kPa) and not more than a gauge pressure of 2.5 psi (17 kPa).

**21.5.2.6** Single-wall underground tanks and piping, before being covered, enclosed, or placed in use, shall be tested for tightness either hydrostatically or with air pressure at not less than a gauge pressure of 3 psi (20 kPa) and not more than a gauge pressure of 5 psi (35 kPa).

**21.5.2.7\*** Underground secondary containment tanks and horizontal aboveground secondary containment tanks shall have the primary (inner) tank tested for tightness either hydrostatically or with air pressure at not less than a gauge pressure of 3 psi (20 kPa) and not more than a gauge pressure of 5 psi (35 kPa).

**21.5.2.7.1** The interstitial space of such tanks shall be tested either hydrostatically or with air pressure at a gauge pressure of 3 to 5 psi (20 to 35 kPa), by vacuum at 5.3 in. Hg (18 kPa), or in accordance with the tank's listing or the manufacturer's instructions. These limits shall not be exceeded.

**21.5.2.7.2** The pressure or vacuum shall be held for not less than 1 hour or for the duration specified in the listing procedures for the tank.

**21.5.2.8** Vertical aboveground secondary containment-type tanks shall have their primary (inner) tank tested for tightness either hydrostatically or with air pressure at not less than a gauge pressure of 1.5 psi (10 kPa) and not more than a gauge pressure of 2.5 psi (17 kPa).

**21.5.2.8.1** The interstitial space of such tanks shall be tested either hydrostatically or with air pressure at a gauge pressure of 1.5 to 2.5 psi (10 to 17 kPa), by vacuum at 5.3 in. Hg (18 kPa), or in accordance with the tank's listing or manufacturer's instructions. These limits shall not be exceeded.

**21.5.2.8.2** The pressure or vacuum shall be held for not less than 1 hour or for the duration specified in the listing procedures for the tank.

**21.5.3\* Periodic Testing.** Each tank shall be tested when required by the manufacturer's instructions and applicable standards to ensure the integrity of the tank.

## 21.6 Fire Prevention and Control.

### 21.6.1 General Requirements.

**21.6.1.1** This section shall apply to the commonly recognized management techniques and fire control methods used to prevent or minimize the loss from fire or explosion in tank storage facilities. The wide range in size, design, and location of tank storage facilities shall preclude the inclusion of detailed fire prevention and control methods applicable to all such facilities.

**21.6.1.2** Tank storage facilities shall establish and implement fire prevention and control methods for life safety, for minimizing property loss, and for reducing fire exposure to adjoining facilities resulting from fire and explosion. Compliance with 21.6.2 through 21.6.6 shall be deemed as meeting the requirements of 21.6.1.

**21.6.2 Control of Ignition Sources.** In order to prevent the ignition of flammable vapors in tank storage facilities, ignition sources shall be controlled in accordance with Chapter 6.

**21.6.3 Management of Fire and Explosion Hazards.** The extent of fire and explosion prevention and control procedures and measures provided for tank storage facilities shall be determined by an engineering evaluation of the installation and operation, followed by the application of recognized fire and explosion prevention and process engineering principles. The evaluation shall include, but not be limited to, the following:

- (1) Analysis of fire and explosion hazards of the facility
- (2) Analysis of local conditions, such as exposure to and from adjacent properties, flood potential, or earthquake potential
- (3) Fire department or mutual aid response

**21.6.4 Fire Control.** Tank storage facilities for flammable and combustible liquids shall be reviewed to ensure that fire and explosion hazards resulting from loss of containment of liquids are provided with corresponding fire prevention and emergency action plans. (See also Section 6.3.)

### 21.6.5 Emergency Planning and Training.

**21.6.5.1\*** An emergency plan, consistent with the available equipment, resources, and personnel, shall be established and implemented to respond to fires and explosions, and other emergencies. This plan shall address the following:

- (1) Procedures to be used in case of fire, explosion, or accidental release of liquid or vapor including, but not limited to, sounding the alarm, notifying the fire department,

evacuating personnel, controlling and mitigating the explosion, and controlling and extinguishing the fire

- (2) Appointing and training of personnel to carry out emergency response duties
- (3) Maintenance of fire protection, spill control and containment, and other emergency response equipment
- (4) Conducting emergency response drills
- (5) Shutdown or isolation of equipment to control unintentional releases
- (6) Alternative measures for the safety of personnel while any fire protection or other emergency response equipment is shut down or inoperative

**21.6.5.2** Personnel responsible for the use and operation of fire protection equipment shall be trained in the use of and be able to demonstrate knowledge of the use or operation of that equipment. Refresher training shall be conducted at least annually.

**21.6.5.3** Planning of effective fire control measures shall be coordinated with local emergency response agencies and shall include, but not be limited to, the identification of all tanks by location, contents, size, and hazard identification as required in 21.7.2.1.

**21.6.5.4** Procedures shall be established to provide for safe shutdown of tank storage facilities under emergency conditions and for safe return to service. These procedures shall provide requirements for periodic training of personnel and scheduled inspection and testing of associated alarms, interlocks, and controls.

**21.6.5.5** Emergency procedures shall be kept available in an operating area. The procedures shall be reviewed and updated whenever conditions change. (See 6.4.2.)

**21.6.5.6** Where tank storage facilities are unattended, a summary of the emergency plan shall be posted or located in a strategic location that is accessible to emergency responders.

#### **21.6.6 Inspection and Maintenance of Fire Protection and Emergency Response Equipment.**

**21.6.6.1\*** All fire protection and emergency response equipment shall be maintained, inspected, and tested in accordance with regulatory requirements, standard practices, and equipment manufacturers' recommendations.

**21.6.6.2** Maintenance and operating procedures and practices at tank storage facilities shall be established and implemented to control leakage and prevent spillage and release of liquids.

**21.6.6.3** Ground areas around tank storage facilities shall be kept free of weeds, trash, and other unnecessary combustible materials.

**21.6.6.4** Accessways established for movement of personnel shall be maintained clear of obstructions to permit evacuation and access for manual fire fighting and emergency response in accordance with regulatory requirements and the emergency plan.

**21.6.6.5** Combustible waste material and residues in operating areas shall be kept to a minimum, stored in covered metal containers, and disposed of daily.

**21.6.6.6** Personnel responsible for the inspection and maintenance of fire protection and emergency response equipment shall be trained and shall be able to demonstrate knowledge of the inspection and maintenance of that equipment. Refresher training shall be conducted as needed to maintain proficiency.

#### **21.7 Operation of Storage Tanks.**

**21.7.1\* Prevention of Overfilling of Storage Tanks.** Facilities with aboveground tanks larger than 1320 gal (5000 L) storing Class I or Class II liquids shall establish procedures or shall provide equipment, or both, to prevent overfilling of tanks.

**21.7.1.1** Facilities with aboveground tanks that receive and transfer Class I liquids from mainline pipelines or marine vessels shall establish and follow formal written procedures to prevent overfilling of tanks utilizing one of the following methods of protection:

- (1) Tanks shall be gauged at intervals in accordance with established procedures by personnel continuously on the premises during product receipt. Acknowledged communication shall be maintained with the supplier so flow can be shut down or diverted in accordance with established procedures.
- (2) Tanks shall be equipped with a high-level detection device that is either independent of any gauging equipment or incorporates a gauging and alarm system that provides electronic self-checking to indicate when the gauging and alarm system has failed. Alarms shall be located where personnel who are on duty throughout product transfer can arrange for flow stoppage or diversion in accordance with established procedures.
- (3) Tanks shall be equipped with an independent high-level detection system that will automatically shut down or divert flow in accordance with established procedures.

**21.7.1.2** Alternatives to instrumentation described in 21.7.1.1(2) and 21.7.1.1(3) shall be allowed where approved as affording equivalent protection.

**21.7.1.3** Instrumentation systems covered in 21.7.1.1(2) and 21.7.1.1(3) shall be wired fail-safe, such that valid alarm conditions or system failures create an alarm condition that will notify personnel or automatically shut down or divert flow.

**21.7.1.3.1** Written instrumentation performance procedures shall be established to define valid alarm conditions and system failures in accordance with API 2350, *Overfill Protection for Storage Tanks in Petroleum Facilities*.

**21.7.1.3.2** System failure shall include but not be limited to the following:

- (1) Loss of main electrical power
- (2) Electrical break, short circuit, or ground fault in the level detection system circuit or the alarm and signal circuit
- (3) Failure or malfunction of the level detection system control equipment or signaling devices

**21.7.1.4** Formal written procedures required by 21.7.1.1 shall include the following:

- (1) Instructions covering methods to check for lineup and receipt of initial delivery to tank designated to receive shipment.
- (2) Provision for training and monitoring the performance of operating personnel by supervisors.
- (3) Schedules and procedures for inspection and testing of gauging equipment and high-level instrumentation and related systems. Inspection and testing intervals shall be approved but shall not exceed 1 year.

**21.7.1.5** An underground tank shall be equipped with overfill prevention equipment that will either alert the transfer operator when the tank is no more than 90 percent full by triggering



an audible and visual high-level alarm or automatically shut off the flow of liquid into the tank when the tank is no more than 95 percent full.

**21.7.1.5.1** Other methods of overflow protection shall be permitted as approved by the authority having jurisdiction.

**21.7.1.6** Shop-fabricated aboveground atmospheric storage tanks, constructed to the recognized standards of 21.4.2.1.1, shall meet the requirements of 21.7.1.6.1 through 21.7.1.6.4 whenever the vertical length from the tank bottom to the top of the fill, normal vent, or emergency vent exceeds 12 ft (3.7 m).

**21.7.1.6.1** An approved means shall be provided to notify the tank filling operator of the pending completion of the tank fill operation at the fill connection.

**21.7.1.6.2** An approved means shall be provided to stop delivery of liquid to the tank prior to the complete filling of the tank.

**21.7.1.6.3** In no case shall these provisions restrict or interfere with the functioning of the normal vent or emergency vent.

**21.7.1.6.4** The manufacturer of the tank shall be consulted to determine if reinforcement of the tank is required. If reinforcement is deemed necessary, it shall be done.

## **21.7.2 Identification and Security.**

**21.7.2.1 Identification for Emergency Responders.** A sign or marking that meets the requirements of NFPA 704, *Standard System for the Identification of the Hazards of Materials for Emergency Response*, or another approved system, shall be applied to storage tanks containing liquids. The marking shall be located where it can be seen, such as on the side of the tank, the shoulder of an accessway or walkway to the tank or tanks, or on the piping outside of the diked area. If more than one tank is involved, the markings shall be so located that each tank can be identified.

**21.7.2.2\* Security for Unsupervised Storage Tanks.** Unsupervised, isolated aboveground storage tanks shall be secured and shall be marked to identify the fire hazards of the tank and the tank's contents to the general public. Where necessary to protect the tank from tampering or trespassing, the area where the tank is located shall be secured.

## **21.7.3 Storage Tanks in Areas Subject to Flooding.**

### **21.7.3.1 Water Loading.**

**21.7.3.1.1** The filling of a tank to be protected by water loading shall be started as soon as floodwaters are predicted to reach a dangerous flood stage.

**21.7.3.1.2** Where independently fueled water pumps are relied on, sufficient fuel shall be available at all times to permit continuing operations until all tanks are filled.

**21.7.3.1.3** Tank valves shall be locked in a closed position when water loading has been completed.

**21.7.3.2 Operating Instructions.** Operating instructions or procedures to be followed in a flood emergency shall be established and implemented by personnel identified in 21.7.3.3.

**21.7.3.3 Personnel Training.** Personnel responsible for activating and performing flood emergency procedures shall be trained in their implementation and shall be informed of the location and operation of valves and other controls and equipment necessary to effect the intent of these procedures. Personnel shall

also be trained in the procedures required to place the facility back into service following a flood emergency.

### **21.7.4 Removal from Service of Storage Tanks.**

**21.7.4.1\* Closure of Aboveground Storage Tanks.** Aboveground tanks taken out of service or abandoned shall be emptied of liquid, rendered vapor-free, and safeguarded against trespassing in accordance with NFPA 326, *Standard for the Safeguarding of Tanks and Containers for Entry, Cleaning, or Repair*, or in accordance with the requirements of the authority having jurisdiction.

**21.7.4.2 Reuse of Aboveground Storage Tanks.** Aboveground tanks shall be permitted to be reused for flammable or combustible liquids service provided they comply with applicable sections of this code and are approved.

### **21.7.4.3 Removal from Service of Underground Storage Tanks.**

**21.7.4.3.1 General.** Underground tanks taken out of service or abandoned shall be emptied of liquid, rendered vapor-free, and safeguarded against trespassing in accordance with this section and in accordance with NFPA 326, *Standard for the Safeguarding of Tanks and Containers for Entry, Cleaning, or Repair*, or in accordance with the requirements of the authority having jurisdiction. The procedures outlined in this section shall be followed when taking underground tanks temporarily out of service, closing them in place permanently, or removing them. (See Annex C for additional information.)

**21.7.4.3.2 Temporary Closure.** Underground tanks shall be rendered temporarily out of service only when it is planned that they will be returned to active service, closed in place permanently, or removed within an approved period not exceeding 1 year. The following requirements shall be met:

- (1) Corrosion protection and release detection systems shall be maintained in operation.
- (2) The vent line shall be left open and functioning.
- (3) The tank shall be secured against tampering.
- (4) All other lines shall be capped or plugged.

**21.7.4.3.2.1** Tanks remaining temporarily out of service for more than 1 year shall be permanently closed in place or removed in accordance with 21.7.4.3.3 or 21.7.4.3.4, as applicable.

**21.7.4.3.3 Permanent Closure in Place.** Underground tanks shall be permitted to be permanently closed in place if approved by the authority having jurisdiction. All of the following requirements shall be met:

- (1) All applicable authorities having jurisdiction shall be notified.
- (2)\*A safe workplace shall be maintained throughout the prescribed activities.
- (3) All flammable and combustible liquids and residues shall be removed from the tank, appurtenances, and piping and shall be disposed of in accordance with regulatory requirements and industry practices, using a written procedure.
- (4) The tank, appurtenances, and piping shall be made safe by either purging them of flammable vapors or inerting the potential explosive atmosphere. Confirmation that the atmosphere in the tank is safe shall be by testing of the atmosphere using a combustible gas indicator if purging, or an oxygen meter if inerting, at intervals in accordance with written procedures.
- (5) Access to the tank shall be made by careful excavation to the top of the tank.

- (6) All exposed piping, gauging and tank fixtures, and other appurtenances, except the vent, shall be disconnected and removed.
- (7) The tank shall be completely filled with an inert solid material.
- (8) The tank vent and remaining underground piping shall be capped or removed.
- (9) The tank excavation shall be backfilled.

**21.7.4.3.4 Removal and Disposal.** Underground tanks and piping shall be removed in accordance with the following requirements:

- (1) The steps described in 21.7.4.3.3(1) through 21.7.4.3.3(5) shall be followed.
- (2) All exposed piping, gauging and tank fixtures, and other appurtenances, including the vent, shall be disconnected and removed.
- (3) All openings shall be plugged, leaving a ¼ in. (6 mm) opening to avoid buildup of pressure in the tank.
- (4) The tank shall be removed from the excavated site and shall be secured against movement.
- (5) Any corrosion holes shall be plugged.
- (6) The tank shall be labeled with its former contents, present vapor state, vapor-freeing method, and a warning against reuse.
- (7) The tank shall be removed from the site as authorized by the authority having jurisdiction, preferably the same day.

**21.7.4.3.5 Temporary Storage of Removed Tanks.** If it is necessary to temporarily store an underground tank that has been removed, it shall be placed in a secure area where public access is restricted. A ¼ in. (6 mm) opening shall be maintained to avoid buildup of pressure in the tank.

**21.7.4.3.6 Disposal of Tanks.** Disposal of underground tanks shall meet the following requirements:

- (1) Before a tank is cut up for scrap or landfill, the atmosphere in the tank shall be tested in accordance with 21.7.4.3.3(4) to ensure that it is safe.
- (2) The tank shall be made unfit for further use by cutting holes in the tank heads and shell.

**21.7.4.3.7 Documentation.** All necessary documentation shall be prepared and maintained in accordance with all federal, state, and local rules and regulations.

**21.7.4.3.8 Reuse of Underground Storage Tanks.** Underground tanks shall be permitted to be reused for underground storage of flammable or combustible liquids provided they comply with applicable sections of this code and are approved.

**21.7.5\* Leak Detection and Inventory Records for Underground Storage Tanks.** Accurate inventory records or a leak detection program shall be maintained on all Class I liquid storage tanks for indication of leakage from the tanks or associated piping.

**21.8 Inspection and Maintenance of Storage Tanks and Storage Tank Appurtenances.**

**21.8.1\*** Each storage tank constructed of steel shall be inspected and maintained in accordance with API Standard 653, *Tank Inspection, Repair, Alteration, and Reconstruction*, or STI SP001, *Standard for the Inspection of Aboveground Storage Tanks*, whichever is applicable.

**21.8.2** Each storage tank constructed of other materials shall be inspected and maintained in accordance with the manufac-

turer's instructions and applicable standards to ensure compliance with the requirements of this code.

**21.8.3** Testing of storage tanks shall meet the requirements of Section 21.5.

**21.8.4** Each storage tank shall be maintained liquidtight. Each storage tank that is leaking shall be emptied of liquid or repaired in a manner acceptable to the authority having jurisdiction.

**21.8.5** Each storage tank that has been structurally damaged, repaired, reconstructed, relocated, jacked, or damaged by impact, flood, or other trauma, or is suspected of leaking shall be inspected and tested in accordance with Section 21.5 or in a manner acceptable to the authority having jurisdiction.

**21.8.6\*** Storage tanks and their appurtenances, including normal vents, emergency vents, overflow prevention devices, and related devices, shall be inspected and maintained to ensure that they function as intended in accordance with written procedures.

**21.8.7** Openings for gauging on storage tanks storing Class I liquids shall be provided with a vaportight cap or cover. Such covers shall be closed when not gauging.

**21.8.8\*** Facilities with aboveground storage tanks shall establish and implement a procedure to check for and remove water from the bottom of storage tanks that contain nonmiscible liquids.

**21.9 Change of Stored Liquid.** Storage tanks that undergo any change of stored liquid shall be re-evaluated for compliance with Chapters 21 through 25, as applicable.

## Chapter 22 Storage of Liquids in Tanks — Aboveground Storage Tanks

**22.1 Scope.** This chapter shall apply to the following:

- (1) The storage of flammable and combustible liquids, as defined in 3.3.33 and Chapter 4, in fixed tanks that exceed 60 gal (230 L) capacity
- (2) The storage of flammable and combustible liquids in portable tanks that exceed 660 gal (2500 L) capacity
- (3) The storage of flammable and combustible liquids in intermediate bulk containers that exceed 793 gal (3000 L)
- (4) The design, installation, testing, operation, and maintenance of such tanks, portable tanks, and bulk containers

**22.2 Definitions Specific to Chapter 22.** For the purpose of this chapter, the terms in this section shall have the definitions given.

**22.2.1 Fire-Resistant Tank.** An atmospheric aboveground storage tank with thermal insulation that has been evaluated for resistance to physical damage and for limiting the heat transferred to the primary tank when exposed to a hydrocarbon fuel fire and is listed in accordance with UL 2080, *Standard for Fire Resistant Tanks for Flammable and Combustible Liquids*, or an equivalent test procedure.

**22.2.2 Floating Roof Tank.** An aboveground storage tank that incorporates one of the following designs:

- (1) A closed-top pontoon or double-deck metal floating roof in an open-top tank constructed in accordance with API Standard 650, *Welded Steel Tanks for Oil Storage*
- (2) A fixed metal roof with ventilation at the top and roof eaves constructed in accordance with API Standard 650 and containing a closed-top pontoon or double-deck



metal floating roof meeting the requirements of API Standard 650

- (3) A fixed metal roof with ventilation at the top and roof eaves constructed in accordance with API Standard 650 and containing a metal floating cover supported by liquidtight metal floating devices that provide buoyancy to prevent the liquid surface from being exposed when half of the flotation is lost

**22.2.2.1** For the purposes of this chapter, an aboveground storage tank with an internal metal floating pan, roof, or cover that does not meet 22.2.2 or one that uses plastic foam (except for seals) for flotation, even if encapsulated in metal or fiberglass, shall meet the requirements for a fixed roof tank.

**22.2.3 Protected Aboveground Tank.** An atmospheric aboveground storage tank with integral secondary containment and thermal insulation that has been evaluated for resistance to physical damage and for limiting the heat transferred to the primary tank when exposed to a hydrocarbon pool fire and is listed in accordance with ANSI/UL 2085, *Standard for Protected Aboveground Tanks for Flammable and Combustible Liquids*, or an equivalent test procedure.

**22.3 General Requirements.** Storage of Class II and Class III liquids heated at or above their flash point shall follow the requirements for Class I liquids, unless an engineering evaluation conducted in accordance with Chapter 6 justifies following the requirements for some other liquid class.

## 22.4\* Location of Aboveground Storage Tanks.

### 22.4.1 Location with Respect to Property Lines, Public Ways, and Important Buildings.

**22.4.1.1** Tanks storing Class I, Class II, or Class IIIA stable liquids whose internal pressure is not permitted to exceed a gauge pressure of 2.5 psi (17 kPa) shall be located in accordance with Table 22.4.1.1(a) and Table 22.4.1.1(b). Where tank spacing is based on a weak roof-to-shell seam design, the user shall present evidence certifying such construction to the authority having jurisdiction upon request.

**22.4.1.2** Vertical tanks with weak roof-to-shell seams (*see* 22.7.2) that store Class IIIA liquids shall be permitted to be located at one-half the distances specified in Table 22.4.1.1(a), provided the tanks are not within the same diked area as, or within the drainage path of, a tank storing a Class I or Class II liquid.

**22.4.1.3** Tanks storing Class I, Class II, or Class IIIA stable liquids and operating at pressures that exceed a gauge pressure of 2.5 psi (17 kPa), or are equipped with emergency venting that will permit pressures to exceed a gauge pressure of 2.5 psi (17 kPa), shall be located in accordance with Table 22.4.1.3 and Table 22.4.1.1(b).

**22.4.1.4** Tanks storing liquids with boil-over characteristics shall be located in accordance with Table 22.4.1.4. Liquids with boil-over characteristics shall not be stored in fixed roof tanks larger than 150 ft (45 m) in diameter, unless an approved inerting system is provided on the tank.

**Table 22.4.1.1(a) Location of Aboveground Storage Tanks Storing Stable Liquids — Internal Pressure Not to Exceed a Gauge Pressure of 2.5 psi (17 kPa)**

Type of Tank	Protection	Minimum Distance (ft)	
		From Property Line That Is or Can Be Built Upon, Including the Opposite Side of a Public Way <sup>a</sup>	From Nearest Side of Any Public Way or from Nearest Important Building on the Same Property <sup>a</sup>
Floating roof	Protection for exposures <sup>b</sup>	$\frac{1}{2} \times$ diameter of tank	$\frac{1}{6} \times$ diameter of tank
	None	Diameter of tank but need not exceed 175 ft	$\frac{1}{6} \times$ diameter of tank
Vertical with weak roof-to-shell seam	Approved foam or inerting system <sup>c</sup> on tanks not exceeding 150 ft in diameter <sup>d</sup>	$\frac{1}{2} \times$ diameter of tank	$\frac{1}{6} \times$ diameter of tank
	Protection for exposures <sup>b</sup>	Diameter of tank	$\frac{1}{3} \times$ diameter of tank
	None	$2 \times$ diameter of tank but need not exceed 350 ft	$\frac{1}{3} \times$ diameter of tank
Horizontal and vertical tanks with emergency relief venting to limit pressures to 2.5 psi (gauge pressure of 17 kPa)	Approved inerting system <sup>b</sup> on the tank or approved foam system on vertical tanks	$\frac{1}{2} \times$ value in Table 22.4.1.1(b)	$\frac{1}{2} \times$ value in Table 22.4.1.1(b)
	Protection for exposures <sup>b</sup>	Value in Table 22.4.1.1(b)	Value in Table 22.4.1.1(b)
	None	$2 \times$ value in Table 22.4.1.1(b)	Value in Table 22.4.1.1(b)
Protected aboveground tank	None	$\frac{1}{2} \times$ value in Table 22.4.1.1(b)	$\frac{1}{2} \times$ value in Table 22.4.1.1(b)

For SI units, 1 ft = 0.3 m.

<sup>a</sup>The minimum distance cannot be less than 5 ft (1.5 m).

<sup>b</sup>See definition 3.3.46, Protection for Exposures.

<sup>c</sup>See NFPA 69, *Standard on Explosion Prevention Systems*.

<sup>d</sup>For tanks over 150 ft (45 m) in diameter, use "Protection for Exposures" or "None," as applicable.



**Table 22.4.1.1(b) Reference Table for Use with Tables 22.4.1.1(a), 22.4.1.3, and 22.4.1.5**

Tank Capacity (gal)	Minimum Distance (ft)	
	From Property Line that Is or Can Be Built Upon, Including the Opposite Side of a Public Way	From Nearest Side of Any Public Way or from Nearest Important Building on the Same Property
275 or less	5	5
276 to 750	10	5
751 to 12,000	15	5
12,001 to 30,000	20	5
30,001 to 50,000	30	10
50,001 to 100,000	50	15
100,001 to 500,000	80	25
500,001 to 1,000,000	100	35
1,000,001 to 2,000,000	135	45
2,000,001 to 3,000,000	165	55
3,000,001 or more	175	60

For SI units, 1 ft = 0.3 m; 1 gal = 3.8 L.

**Table 22.4.1.3 Location of Aboveground Storage Tanks Storing Stable Liquids — Internal Pressure Permitted to Exceed a Gauge Pressure of 2.5 psi (17 kPa)**

Type of Tank	Protection	Minimum Distance (ft)	
		From Property Line that Is or Can Be Built Upon, Including the Opposite Side of a Public Way	From Nearest Side of Any Public Way or from Nearest Important Building on the Same Property
Any type	Protection for exposures*	$1\frac{1}{2} \times$ value in Table 22.4.1.1(b) but not less than 25 ft	$1\frac{1}{2} \times$ value in Table 22.4.1.1(b) but not less than 25 ft
	None	$3 \times$ value in Table 22.4.1.1(b) but not less than 50 ft	$1\frac{1}{2} \times$ value in Table 22.4.1.1(b) but not less than 25 ft

For SI units, 1 ft = 0.3 m.

\*See definition 3.3.46, Protection for Exposures.

**22.4.1.5** Tanks storing unstable liquids shall be located in accordance with Table 22.4.1.5 and Table 22.4.1.1(b).

**22.4.1.6** Tanks storing Class IIIB stable liquids shall be located in accordance with Table 22.4.1.6.

*Exception: If located within the same diked area as, or within the drainage path of, a tank storing a Class I or Class II liquid, the tank storing Class IIIB liquid shall be located in accordance with 22.4.1.1.*

**22.4.1.7** Where two tank properties of diverse ownership have a common boundary, the authority having jurisdiction shall be permitted, with the written consent of the owners of the two properties, to substitute the distances provided in 22.4.2 for the minimum distances set forth in 22.4.1.1.

**22.4.1.8** Where end failure of a horizontal pressure tank or vessel can expose property, the tank or vessel shall be placed with its longitudinal axis parallel to the nearest important exposure.

**22.4.2 Shell-to-Shell Spacing of Adjacent Aboveground Storage Tanks.**

**22.4.2.1\*** Tanks storing Class I, Class II, or Class IIIA stable liquids shall be separated by the distances given in Table 22.4.2.1.

**22.4.2.1.1** Tanks that store crude petroleum, have individual capacities not exceeding 3000 bbl [126,000 gal (480 m<sup>3</sup>)], and are located at production facilities in isolated locations shall not be required to be separated by more than 3 ft (0.9 m).

**22.4.2.1.2** Tanks used only for storing Class IIIB liquids shall not be required to be separated by more than 3 ft (0.9 m) provided they are not within the same diked area as, or within the drainage path of, a tank storing a Class I or Class II liquid. If located within the same diked area as, or within the drainage path of, a tank storing a Class I or Class II liquid, the tank storing Class IIIB liquid shall be spaced in accordance with the requirements for Class IIIA liquids in Table 22.4.2.1.

**22.4.2.2** A tank storing unstable liquid shall be separated from any other tank containing either an unstable liquid or a Class I, II, or III liquid by a distance not less than one-half the sum of their diameters.

**22.4.2.3** Where tanks are in a diked area containing Class I or Class II liquids or in the drainage path of Class I or Class II liquids and are compacted in three or more rows or in an irregular pattern, greater spacing or other means shall be



**Table 22.4.1.4 Location of Aboveground Storage Tanks Storing Boil-Over Liquids**

Type of Tank	Protection	Minimum Distance (ft)	
		From Property Line that Is or Can Be Built Upon, Including the Opposite Side of a Public Way <sup>a</sup>	From Nearest Side of Any Public Way or from Nearest Important Building on the Same Property <sup>a</sup>
Floating roof	Protection for exposures <sup>b</sup>	$\frac{1}{2} \times$ diameter of tank	$\frac{1}{6} \times$ diameter of tank
	None	Diameter of tank	$\frac{1}{6} \times$ diameter of tank
Fixed roof	Approved foam or inerting system <sup>c</sup>	Diameter of tank	$\frac{1}{3} \times$ diameter of tank
	Protection for exposures <sup>b</sup>	$2 \times$ diameter of tank	$\frac{2}{3} \times$ diameter of tank
	None	$4 \times$ diameter of tank but need not exceed 350 ft	$\frac{2}{3} \times$ diameter of tank

For SI units, 1 ft = 0.3 m.

<sup>a</sup>The minimum distance cannot be less than 5 ft.

<sup>b</sup>See definition 3.3.46, Protection for Exposures.

<sup>c</sup>See NFPA 69, *Standard on Explosion Prevention Systems*.

**Table 22.4.1.5 Location of Aboveground Storage Tanks Storing Unstable Liquids**

Type of Tank	Protection	Minimum Distance (ft)	
		From Property Line that Is or Can Be Built Upon, Including the Opposite Side of a Public Way	From Nearest Side of Any Public Way or from Nearest Important Building on the Same Property <sup>a</sup>
Horizontal and vertical tanks with emergency relief venting to permit pressure not in excess of a gauge pressure of 2.5 psi (17 kPa)	Tank protected with any one of the following: approved water spray, approved inerting, <sup>a</sup> approved insulation and refrigeration, approved barricade	Value in Table 22.4.1.1 (b) but not less than 25 ft	Not less than 25 ft
	Protection for exposures <sup>b</sup>	$2\frac{1}{2} \times$ value in Table 22.4.1.1 (b) but not less than 50 ft	Not less than 50 ft
	None	$5 \times$ value in Table 22.4.1.1 (b) but not less than 100 ft	Not less than 100 ft
Horizontal and vertical tanks with emergency relief venting to permit pressure over a gauge pressure of 2.5 psi (17 kPa)	Tank protected with any one of the following: approved water spray, approved inerting, <sup>a</sup> approved insulation and refrigeration, approved barricade	$2 \times$ value in Table 22.4.1.1 (b) but not less than 50 ft	Not less than 50 ft
	Protection for exposures <sup>b</sup>	$4 \times$ value in Table 22.4.1.1 (b) but not less than 100 ft	Not less than 100 ft
	None	$8 \times$ value in Table 22.4.1.1 (b) but not less than 150 ft	Not less than 150 ft

For SI units, 1 ft = 0.3 m.

<sup>a</sup>See NFPA 69, *Standard on Explosion Prevention Systems*.

<sup>b</sup>See definition 3.3.46, Protection for Exposures.

**Table 22.4.1.6 Location of Aboveground Storage Tanks Storing Class IIIB Liquids**

Tank Capacity (gal)	Minimum Distance (ft)	
	From Property Line that Is or Can Be Built Upon, Including the Opposite Side of a Public Way	From Nearest Side of Any Public Way or from Nearest Important Building on the Same Property
12,000 or less	5	5
12,001 to 30,000	10	5
30,001 to 50,000	10	10
50,001 to 100,000	15	10
100,001 or more	15	15

For SI units, 1 ft = 0.3 m; 1 gal = 3.8 L.

**Table 22.4.2.1 Minimum Shell-to-Shell Spacing of Aboveground Storage Tanks**

Tank Diameter	Floating Roof Tanks	Fixed or Horizontal Tanks	
		Class I or II Liquids	Class IIIA Liquids
All tanks not over 150 ft (45 m) in diameter	$\frac{1}{6} \times$ sum of adjacent tank diameters but not less than 3 ft (0.9 m)	$\frac{1}{6} \times$ sum of adjacent tank diameters but not less than 3 ft (0.9 m)	$\frac{1}{6} \times$ sum of adjacent tank diameters but not less than 3 ft (0.9 m)
Tanks larger than 150 ft (45 m) in diameter:			
If remote impounding is provided in accordance with 22.11.1	$\frac{1}{6} \times$ sum of adjacent tank diameters	$\frac{1}{4} \times$ sum of adjacent tank diameters	$\frac{1}{6} \times$ sum of adjacent tank diameters
If open diking is provided in accordance with 22.11.2	$\frac{1}{4} \times$ sum of adjacent tank diameters	$\frac{1}{3} \times$ sum of adjacent tank diameters	$\frac{1}{4} \times$ sum of adjacent tank diameters

Note: The “sum of adjacent tank diameters” means the sum of the diameters of each pair of tanks that are adjacent to each other. See also A.22.4.2.1.

permitted to be required by the authority having jurisdiction to make tanks in the interior of the pattern accessible for fire-fighting purposes.

**22.4.2.4** The minimum horizontal separation between an LP-Gas container and a Class I, Class II, or Class IIIA liquid storage tank shall be 20 ft (6 m).

**22.4.2.4.1** Means shall be provided to prevent Class I, Class II, or Class IIIA liquids from accumulating under adjacent LP-Gas containers by means of dikes, diversion curbs, or grading.

**22.4.2.4.2** Where flammable or combustible liquid storage tanks are within a diked area, the LP-Gas containers shall be outside the diked area and at least 3 ft (0.9 m) away from the centerline of the wall of the diked area.

**22.4.2.5** If a tank storing a Class I, Class II, or Class IIIA liquid operates at pressures exceeding a gauge pressure of 2.5 psi (17 kPa) or is equipped with emergency relief venting that will permit pressures to exceed a gauge pressure of 2.5 psi (17 kPa), it shall be separated from an LP-Gas container by the appropriate distance given in Table 22.4.2.1.

**22.4.2.6** The requirements of 22.4.2.4 shall not apply where LP-Gas containers of 125 gal (475 L) or less capacity are installed adjacent to fuel oil supply tanks of 660 gal (2500 L) or less capacity.

## 22.5 Installation of Aboveground Storage Tanks.

### 22.5.1 Tank Supports.

**22.5.1.1** Tank supports shall be designed and constructed in accordance with recognized engineering standards.

**22.5.1.2** Tanks shall be supported in a manner that prevents excessive concentration of loads on the supported portion of the shell.

**22.5.1.3** In areas subject to earthquakes, tank supports and connections shall be designed to resist damage as a result of such shocks.

### 22.5.2 Foundations for and Anchoring of Aboveground Storage Tanks.

**22.5.2.1\*** Tanks shall rest on the ground or on foundations made of concrete, masonry, piling, or steel.

**22.5.2.2** Tank foundations shall be designed to minimize the possibility of uneven settling of the tank and to minimize corrosion in any part of the tank resting on the foundation.

**22.5.2.3** Where tanks storing Class I, Class II, or Class IIIA liquids are supported above their foundations, tank supports shall be of concrete, masonry, or protected steel.



*Exception:* Single wood timber supports (not cribbing), laid horizontally, shall be permitted to be used for outside aboveground tanks if not more than 12 in. (300 mm) high at their lowest point.

**22.5.2.4\*** Steel support structures or exposed piling for tanks storing Class I, Class II, or Class IIIA liquids shall be protected by materials having a fire resistance rating of not less than 2 hours.

*Exception No. 1:* Steel saddles do not need to be protected if less than 12 in. (300 mm) high at their lowest point.

*Exception No. 2:* At the discretion of the authority having jurisdiction, water spray protection in accordance with NFPA 15, *Standard for Water Spray Fixed Systems for Fire Protection*, or NFPA 13, *Standard for the Installation of Sprinkler Systems*, is permitted to be used.

**22.5.2.5** Where a tank is located in an area subject to flooding, provisions shall be taken to prevent tanks, either full or empty, from floating during a rise in water level up to the established maximum flood stage. (See 21.7.3.)

**22.6 Vent Piping for Aboveground Tanks.** Piping for normal and emergency relief venting shall be constructed in accordance with Chapter 27.

**22.7 Emergency Relief Venting for Fire Exposure for Aboveground Storage Tanks.**

**22.7.1 General.**

**22.7.1.1** Every aboveground storage tank shall have emergency relief venting in the form of construction or a device or devices that will relieve excessive internal pressure caused by an exposure fire.

**22.7.1.1.1** This requirement shall apply to each compartment of a compartmented tank, the interstitial space (annulus) of a secondary containment-type tank, and the enclosed space of tanks of closed-top dike construction.

**22.7.1.1.2** This requirement shall also apply to spaces or enclosed volumes, such as those intended for insulation, membranes, or weather shields, that are capable of containing liquid because of a leak from the primary vessel. The insulation, membrane, or weather shield shall not interfere with emergency venting.

**22.7.1.1.3** Tanks storing Class IIIB liquids that are larger than 12,000 gal (45,400 L) capacity and are not within the diked area or the drainage path of tanks storing Class I or Class II liquids shall not be required to meet the requirements of 22.7.1.1.

**22.7.1.2** For vertical tanks, the emergency relief venting construction referred to in 22.7.1.1 shall be permitted to be a floating roof, a lifter roof, a weak roof-to-shell seam, or another approved pressure-relieving construction.

**22.7.1.3** If unstable liquids are stored, the effects of heat or gas resulting from polymerization, decomposition, condensation, or self-reactivity shall be taken into account.

**22.7.1.4** If two-phase flow is anticipated during emergency venting, an engineering evaluation shall be conducted in order to size the pressure-relieving devices.

**22.7.2 Weak Roof-to-Shell Seam Construction.** If used, a weak roof-to-shell seam shall be constructed to fail preferential to any other seam and shall be designed in accordance with API Standard 650, *Welded Steel Tanks for Oil Storage*.

**22.7.3 Pressure-Relieving Devices.**

**22.7.3.1\*** Where entire dependence for emergency relief venting is placed upon pressure-relieving devices, the total venting capacity of both normal and emergency vents shall be sufficient to prevent rupture of the shell or bottom of a vertical tank or of the shell or heads of a horizontal tank.

**22.7.3.2** Except as provided for in 22.7.3.5, 22.7.3.6 and 22.7.3.7, the total emergency relief venting capacity of both normal and emergency venting devices shall be not less than that determined in Table 22.7.3.2. (See Annex B for the square footage of typical tank sizes.)

**22.7.3.2.1** Emergency relief vent devices shall be vaportight and shall be permitted to be any one of the following:

- (1) Self-closing manway cover
- (2) Manway cover provided with long bolts that permit the cover to lift under internal pressure
- (3) Additional or larger relief valve or valves

**Table 22.7.3.2 Required Emergency Relief Venting — Cubic Feet of Free Air per Hour (CFH) versus Wetted Area of Tank Shell (ft<sup>2</sup>)**

ft <sup>2</sup>	CFH	ft <sup>2</sup>	CFH	ft <sup>2</sup>	CFH
20	21,100	160	168,000	900	493,000
30	31,600	180	190,000	1000	524,000
40	42,100	200	211,000	1200	557,000
50	52,700	250	239,000	1400	587,000
60	63,200	300	265,000	1600	614,000
70	73,700	350	288,000	1800	639,000
80	84,200	400	312,000	2000	662,000
90	94,800	500	354,000	2400	704,000
100	105,000	600	392,000	2800	742,000
120	126,000	700	428,000	and over	
140	147,000	800	462,000		

For SI units, 10 ft<sup>2</sup> = 0.93 m<sup>2</sup>; 36 ft<sup>3</sup> = 1.0 m<sup>3</sup>.

Notes:

(1) Interpolate for intermediate values not specified in the table.

(2) CFH is flow capacity at absolute pressure of 14.7 psi (101 kPa) and 60°F (15.6°C). See 22.7.3.10.2.

**22.7.3.2.2** The wetted area of the tank shall be calculated as follows:

- (1) Fifty-five percent of the total exposed area of a sphere or spheroid
- (2) Seventy-five percent of the total exposed area of a horizontal tank
- (3) One hundred percent of the exposed shell and floor area of a rectangular tank, but excluding the top surface of the tank
- (4) The first 30 ft (9 m) above grade of the exposed shell area of a vertical tank

**22.7.3.3\*** The total emergency relief venting capacity for tanks and storage vessels designed to operate at pressures above a gauge pressure of 1.0 psi (6.9 kPa) shall be as follows:

- (1) For tanks whose wetted area does not exceed 2800 ft<sup>2</sup> (260 m<sup>2</sup>), not less than that determined in Table 22.7.3.2
- (2) For tanks whose wetted area exceeds 2800 ft<sup>2</sup> (260 m<sup>2</sup>), not less than that determined in Table 22.7.3.3 or not less than that calculated by the following formula:

$$CFH = 1107(A)^{0.82} \quad [22.7.3.3]$$

where:

CFH = venting capacity requirement (ft<sup>3</sup> of free air per hour)

A = wetted area (ft<sup>2</sup>)

**Table 22.7.3.3 Required Emergency Relief Venting for Tanks with Wetted Area over 2800 ft<sup>2</sup> (260 m<sup>2</sup>) and Operating at Gauge Pressure over 1 psi (6.9 kPa) — Cubic Feet of Free Air per Hour (CFH) versus Wetted Area of Tank Shell (ft<sup>2</sup>)**

ft <sup>2</sup>	CFH	ft <sup>2</sup>	CFH
2,800	742,000	9,000	1,930,000
3,000	786,000	10,000	2,110,000
3,500	892,000	15,000	2,940,000
4,000	995,000	20,000	3,720,000
4,500	1,100,000	25,000	4,470,000
5,000	1,250,000	30,000	5,190,000
6,000	1,390,000	35,000	5,900,000
7,000	1,570,000	40,000	6,570,000
8,000	1,760,000		

For SI units, 10 ft<sup>2</sup> = 0.93 m<sup>2</sup>; 36 ft<sup>3</sup> = 1.0 m<sup>3</sup>.

Notes:

- (1) Interpolate for intermediate values not specified in the table.
- (2) CFH is flow capacity at absolute pressure of 14.7 psi (101 kPa) and 60°F (15.6°C). See 22.7.3.10.2.

**22.7.3.4** The total emergency relief venting capacity for any specific stable liquid shall be permitted to be determined by the following formula:

$$CFH = V \frac{1337}{L\sqrt{M}} \quad [22.7.3.4]$$

where:

CFH = venting capacity requirement (ft<sup>3</sup> of free air per hour)

V = ft<sup>3</sup> of free air per hour (CFH) value from Table 22.7.3.2

L = latent heat of vaporization of specific liquid (Btu/lb)

M = molecular weight of specific liquids

**22.7.3.5** Except as provided for in 22.7.3.6 and 22.7.3.7, for tanks containing stable liquids, the required emergency relief venting capacity determined by 22.7.3.2, 22.7.3.3, or 22.7.3.4 shall be permitted to be multiplied by one of the following reduction factors when protection is provided as indicated. Only one of the following factors shall be used for any one tank:

- (1) A reduction factor of 0.5 shall be allowed for tanks with wetted area greater than 200 ft<sup>2</sup> (19 m<sup>2</sup>) that are provided with drainage that meets the requirements of 22.11.1.
- (2) A reduction factor of 0.3 shall be allowed for tanks that are protected with a water spray system that meets the requirements of NFPA 15, *Standard for Water Spray Fixed Systems for Fire Protection*, and that are provided with drainage that meets the requirements of 22.11.1.
- (3) A reduction factor of 0.3 shall be allowed for tanks that are protected with an automatically actuated water spray system that meets the requirements of NFPA 15, *Standard for Water Spray Fixed Systems for Fire Protection*.
- (4) A reduction factor of 0.3 shall be allowed for tanks protected with insulation that meets the requirements of 22.7.3.8.
- (5) A reduction factor of 0.15 shall be allowed for tanks that are protected with a water spray system that meets the requirements of NFPA 15, *Standard for Water Spray Fixed Systems for Fire Protection*, and that have insulation that meets the requirements of 22.7.3.8.

**22.7.3.6\*** Where water-miscible liquids whose heats of combustion and rates of burning are equal to or less than those of ethyl alcohol (ethanol) are stored, processed, or handled and where there is no potential fire exposure from liquids other than these liquids, the emergency relief venting capacity shall be permitted to be reduced by an additional 50 percent. Drainage shall not be required to obtain this reduction. In no case shall the factors in 22.7.3.5(1) through 22.7.3.5(5) be reduced to less than 0.15.

**22.7.3.7\*** Where liquids that are not water-miscible and whose heats of combustion and rates of burning are equal to or less than those of ethyl alcohol (ethanol) are stored, processed, or handled and where there is no potential fire exposure from liquids other than these liquids, the emergency relief venting capacity determined by 22.7.3.5(1) or 22.7.3.5(3) shall be permitted to be reduced by an additional 50 percent. No further reduction shall be allowed for protection by means of water spray. Drainage shall not be required to obtain this reduction. In no case shall the factors in 22.7.3.5(1) through 22.7.3.5(5) be reduced to less than 0.15.

**22.7.3.8** Insulation for which credit is taken in 22.7.3.5(4) and 22.7.3.5(5) shall meet the following performance criteria:

- (1) The insulation shall remain in place under fire exposure conditions.
- (2) The insulation shall withstand dislodgment when subjected to hose stream impingement during fire exposure.
- (3) The insulation shall maintain a maximum conductance value of 4.0 Btu/hr/ft<sup>2</sup>/°F (2.3 W/m<sup>2</sup>/°C) when the outer insulation jacket or cover is at a temperature of 1660°F (904°C) and when the mean temperature of the insulation is 1000°F (538°C).



*Exception: The requirement of 22.7.3.8(2) need not apply where use of solid hose streams is not contemplated or would not be practical.*

**22.7.3.9** The outlets of all vents and vent drains on tanks equipped with emergency relief venting that permits pressures to exceed a gauge pressure of 2.5 psi (17.2 kPa) shall be arranged to discharge so that localized overheating or flame impingement on any part of the tank will not occur if vapors from the vents are ignited.

**22.7.3.10** Each commercial tank venting device shall have the following information either stamped or cast into the metal body of the device or included on a metal nameplate permanently affixed to it.

- (1) Start-to-open pressure
- (2) Pressure at which the valve reaches the full open position
- (3) Flow capacity at the pressure indicated by 22.7.3.10(2)

**22.7.3.10.1** If the start-to-open pressure is less than a gauge pressure of 2.5 psi (17.2 kPa) and the pressure at the full open position is greater than a gauge pressure of 2.5 psi (17.2 kPa), the flow capacity at a gauge pressure of 2.5 psi (17.2 kPa) shall also be stamped on the venting device.

**22.7.3.10.2** The flow capacity shall be expressed in cubic feet per hour of air at 60°F (15.6°C) and an absolute pressure of 14.7 psi (101 kPa).

**22.7.3.10.3** The flow capacity of tank venting devices less than 8 in. (200 mm) in nominal pipe size shall be determined by actual test. These tests shall be permitted to be conducted by a qualified, impartial outside agency or by the manufacturer if certified by a qualified, impartial observer.

**22.7.3.10.4\*** The flow capacity of tank venting devices equal to or greater than 8 in. (200 mm) nominal pipe size, including manway covers with long bolts, shall be determined by test or by calculation. If determined by calculation, the opening pressure shall be measured by test, the calculation shall be based on a flow coefficient of 0.5 applied to the rated orifice, the rating pressure and corresponding free orifice area shall be stated, and the word *calculated* shall appear on the nameplate.

**22.7.4\* Extension of Emergency Vent Piping.** Piping to or from approved emergency vent devices for atmospheric and low-pressure tanks shall be sized to provide emergency vent flows that limit the back pressure to less than the maximum pressure permitted by the design of the tank. Piping to or from approved emergency vent devices for pressure vessels shall be sized in accordance with the ASME *Boiler and Pressure Vessel Code*.

## 22.8 Fire Protection for Aboveground Storage Tanks.

**22.8.1\*** A fire-extinguishing system in accordance with an applicable NFPA standard shall be provided or shall be available for vertical atmospheric fixed-roof storage tanks larger than 50,000 gal (190 m<sup>3</sup>) capacity, storing Class I liquids, if located in a congested area where there is an unusual exposure hazard to the tank from adjacent property or to adjacent property from the tank.

**22.8.2** Fixed-roof tanks storing Class II or Class III liquids at temperatures below their flash points and floating-roof tanks storing any liquid shall not require protection when installed in accordance with this chapter.

## 22.9 Additional Requirements for Fire-Resistant Aboveground Storage Tanks.

**22.9.1** Fire-resistant tanks shall be tested and listed in accordance with UL 2080, *Standard for Fire Resistant Tanks for Flammable and Combustible Liquids*.

**22.9.2** Fire-resistant tanks shall also meet both of the following requirements:

- (1) The construction that provides the required fire-resistive protection shall reduce the heat transferred to the primary tank in order to limit the temperature of the primary tank to an average maximum rise of 800°F (430°C) and a single point maximum rise of 1000°F (540°C) and to prevent release of liquid, failure of the primary tank, failure of the supporting structure, and impairment of venting for a period of not less than 2 hours when tested using the fire exposure specified in UL 2080.
- (2) Reduction in sizing of the emergency vents in accordance with 22.7.3.5 shall not be permitted.

## 22.10 Additional Requirements for Protected Aboveground Storage Tanks.

**22.10.1** Protected aboveground tanks shall be tested and listed in accordance with ANSI/UL 2085, *Standard for Protected Aboveground Tanks for Flammable and Combustible Liquids*.

**22.10.2** Protected aboveground tanks shall also meet both of the following requirements:

- (1) The construction that provides the required fire-resistive protection shall reduce the heat transferred to the primary tank in order to limit the temperature of the primary tank to an average maximum rise of 260°F (144°C) and a single point maximum rise of 400°F (204°C) and to prevent release of liquid, failure of the primary tank, failure of the supporting structure, and impairment of venting for a period of not less than 2 hours when tested using the fire exposure specified in ANSI/UL 2085, *Standard for Protected Aboveground Tanks for Flammable and Combustible Liquids*.
- (2) Reduction in sizing of the emergency vents in accordance with 22.7.3.5 shall not be permitted.

**22.11\* Control of Spills from Aboveground Storage Tanks.** Every tank that contains a Class I, Class II, or Class IIIA liquid shall be provided with means to prevent an accidental release of liquid from endangering important facilities and adjoining property or from reaching waterways. Such means shall meet the requirements of 22.11.1, 22.11.2, 22.11.3, or 22.11.4, whichever is applicable.

**22.11.1 Remote Impounding.** Where control of spills is provided by drainage to a remote impounding area so that spilled liquid does not collect around tanks, the requirements of 22.11.1.1 through 22.11.1.4 shall apply.

**22.11.1.1** The drainage route shall have a slope of not less than 1 percent away from the tank for at least 50 ft (15 m) toward the impounding area.

**22.11.1.2** The impounding area shall have a capacity not less than that of the largest tank that drains into it.

*Exception: Where compliance with 22.11.1.2 is not possible because there is not enough open area around the tanks, "partial" remote impounding for a percentage of the required capacity is permitted. The remainder of the volume required for spill control can be provided by open diking meeting the requirements of 22.11.2.*

**22.11.1.3** The drainage route shall be located so that, if the liquid in the drainage system is ignited, the fire will not seriously expose tanks or adjoining property.

**22.11.1.4** The impounding area shall be located so that, when filled to capacity, the liquid will not be closer than 50 ft (15 m) from any property line that is or can be built upon or from any tank.

*Exception: Where partial remote impounding as provided for in 22.11.1.2 is used, the liquid in the partial remote impounding area shall meet the requirements of 22.11.1.4. Tank spacing shall be determined based on the diked tank provisions of Table 22.4.2.1.*

**22.11.2 Impounding Around Tanks by Open Diking.** Where control of spills is provided by means of impounding by open diking around the tanks, such systems shall meet the requirements of 22.11.2.1 through 22.11.2.8.

**22.11.2.1** A slope of not less than 1 percent away from the tank shall be provided for at least 50 ft (15 m) or to the dike base, whichever is less.

**22.11.2.2\*** The volumetric capacity of the diked area shall not be less than the greatest amount of liquid that can be released from the largest tank within the diked area, assuming a full tank.

**22.11.2.2.1** To allow for volume occupied by tanks, the capacity of the diked area enclosing more than one tank shall be calculated after deducting the volume of the tanks, other than the largest tank, below the height of the dike.

**22.11.2.3** To permit access, the outside base of the dike at ground level shall be no closer than 10 ft (3 m) to any property line that is or can be built upon.

**22.11.2.4** Walls of the diked area shall be of earth, steel, concrete, or solid masonry designed to be liquidtight and to withstand a full hydrostatic head.

**22.11.2.4.1\*** Earthen walls 3 ft (0.9 m) or more in height shall have a flat section at the top not less than 2 ft (0.6 m) wide and shall have a slope that is consistent with the angle of repose of the material of which the wall is constructed.

**22.11.2.5** Where the average interior height of the walls of the diked area exceeds 6 ft (1.8 m), provisions shall be made for normal access; necessary emergency access to tanks, valves, and other equipment; and egress from the diked enclosure. The following requirements shall apply:

- (1) Where the average height of a dike containing Class I liquids is over 12 ft (3.6 m) high, measured from interior grade, or where the distance between any tank and the top inside edge of the dike wall is less than the height of the dike wall, provisions shall be made for operation of valves and for access to tank roof(s) without entering below the top of the dike. These provisions shall be permitted to be met through the use of remote-operated valves, elevated walkways, or other arrangements.
- (2) Piping passing through dike walls shall be designed to withstand imposed stresses as a result of settlement or fire exposure.
- (3) The distance between the shell of any tank and the toe of the interior of the dike wall shall be not less than 5 ft (1.5 m).

**22.11.2.6** Each diked area containing two or more tanks shall be subdivided, preferably by drainage channels or at least by

intermediate dikes, in order to prevent minor spills from a tank from endangering adjacent tanks within the diked area.

**22.11.2.6.1** The drainage channels or intermediate dikes shall be located between tanks so as to take full advantage of the space with due regard for the individual tank capacities.

**22.11.2.6.2** Intermediate dikes shall be not less than 18 in. (450 mm) in height.

**22.11.2.6.3** Subdivision shall be provided according to the requirements of 22.11.2.6.3.1, 22.11.2.6.3.2, 22.11.2.6.3.3, 22.11.2.6.3.4, or 22.11.2.6.3.5, whichever is applicable.

**22.11.2.6.3.1** Where stable liquids are stored in vertical cone roof tanks of weak roof-to-shell seam design or in floating roof tanks, one subdivision shall be provided for each tank greater than 10,000 bbl (420,000 gal or 1590 m<sup>3</sup>) capacity. In addition, one subdivision shall be provided for each group of tanks [with no individual tank exceeding 10,000 bbl (420,000 gal or 1590 m<sup>3</sup>) capacity] having an aggregate capacity not greater than 15,000 bbl (630,000 gal or 2385 m<sup>3</sup>).

**22.11.2.6.3.2** Where crude petroleum is stored in producing areas in any type of tank, one subdivision shall be provided for each tank greater than 10,000 bbl (420,000 gal or 1590 m<sup>3</sup>) capacity. In addition, one subdivision shall be provided for each group of tanks [with no individual tank exceeding 10,000 bbl (420,000 gal or 1590 m<sup>3</sup>) capacity] having an aggregate capacity not greater than 15,000 bbl (630,000 gal or 2385 m<sup>3</sup>).

**22.11.2.6.3.3** Where stable liquids are stored in tanks not covered in 22.11.2.6.3.1, one subdivision shall be provided for each tank greater than 2380 bbl (100,000 gal or 380 m<sup>3</sup>) capacity. In addition, one subdivision shall be provided for each group of tanks [with no individual tank exceeding 2380 bbl (100,000 gal or 380 m<sup>3</sup>) capacity] having an aggregate capacity not greater than 3750 bbl (150,000 gal or 570 m<sup>3</sup>).

**22.11.2.6.3.4\*** Where unstable liquids are stored in any type of tank, one subdivision shall be provided for each tank.

*Exception: Tanks that store unstable liquids and that are installed with drainage meeting the requirements of NFPA 15, Standard for Water Spray Fixed Systems for Fire Protection, need not meet this requirement.*

**22.11.2.6.3.5** Whenever two or more tanks storing Class I liquids, any one of which is over 150 ft (45 m) in diameter, are located in a common diked area, intermediate dikes shall be provided between adjacent tanks to hold at least 10 percent of the capacity of the tank so enclosed, not including the volume displaced by the tank.

**22.11.2.7** Where provision is made for draining water from diked areas, such drains shall be controlled to prevent liquids from entering natural water courses, public sewers, or public drains.

**22.11.2.7.1** Control of drainage shall be accessible under fire conditions from outside the dike.

**22.11.2.8** Storage of combustible materials, empty drums, full drums, or barrels shall not be permitted within the diked area.

**22.11.3 Impounding Around Tanks by Closed-Top Diking.** Where control of spills is provided by means of impounding by closed-top diking around the tanks, such systems shall meet all of the requirements of 22.11.4 or shall meet the requirements of 22.11.3.1 through 22.11.3.4.



**22.11.3.1\*** The volumetric capacity of the diked area shall not be less than the greatest amount of liquid that can be released from the largest tank within the diked area, assuming a full tank.

**22.11.3.2** To allow for volume occupied by tanks, the capacity of the diked area enclosing more than one tank shall be calculated after deducting the volume of the tanks, other than the largest tank, below the height of the dike.

**22.11.3.3** To permit access, the outside base of the dike at ground level shall be no closer than 10 ft (3 m) to any property line that is or can be built upon.

**22.11.3.4** Walls of the diked area shall be of steel, concrete, or solid masonry designed to be liquidtight and to withstand a full hydrostatic head.

**22.11.3.5** Where provision is made for draining water from diked areas, such drains shall be controlled to prevent liquids from entering natural water courses, public sewers, or public drains.

**22.11.3.5.1** Control of drainage shall be accessible under fire conditions from outside the dike.

**22.11.3.6** Storage of combustible materials, empty drums, full drums, or barrels shall not be permitted within the diked area.

**22.11.3.7** The capacity of the primary tank shall not exceed that given in 22.11.4.1.

**22.11.3.8** All piping connections to the tank shall be made above the normal maximum liquid level.

**22.11.3.9** The tank shall be capable of resisting the damage from the impact of a motor vehicle, or collision barriers shall be provided.

**22.11.3.10** Where the means of secondary containment is enclosed, it shall be provided with emergency venting in accordance with Section 22.7.

**22.11.3.11** Means shall be provided to establish the integrity of the secondary containment, in accordance with Chapter 21.

**22.11.3.12** Where the normal vent or the emergency vent device or both discharge outside the enclosure created by the closed-top diking, the tank within the enclosure shall comply with 22.11.4.4 and 22.11.4.5.

**22.11.3.13** Where the fill connection for the tank within the enclosure created by the closed-top diking is not located within the enclosure, the tank shall meet the requirements of 22.11.4.4 and 22.11.4.5.

**22.11.4 Secondary Containment-Type Aboveground Storage Tanks.** Where a secondary containment-type tank is used to provide spill control, the tank shall meet all of the requirements of 22.11.4.1 through 22.11.4.10.

**22.11.4.1** The capacity of the listed primary tank for Classes I, II, and IIIA liquids shall not exceed 50,000 gal (189,000 L).

**22.11.4.2** All piping connections to the tank shall be made above the maximum liquid level.

**22.11.4.3** Means shall be provided to prevent the release of liquid from the tank by siphon flow.

**22.11.4.4** Means shall be provided for determining the level of liquid in the tank. This means shall be accessible to the delivery operator.

**22.11.4.5** Means shall be provided to prevent overfilling by sounding an alarm when the liquid level in the tank reaches 90 percent of capacity and by automatically stopping delivery of liquid to the tank when the liquid level in the tank reaches 95 percent of capacity.

**22.11.4.5.1** In no case shall these provisions restrict or interfere with the functioning of the normal vent or the emergency vent.

**22.11.4.6** Spacing between adjacent tanks shall comply with Table 22.4.2.1.

**22.11.4.7** The tank shall be capable of resisting the damage from the impact of a motor vehicle, or collision barriers shall be provided.

**22.11.4.8** Where the means of secondary containment is enclosed, it shall be provided with emergency venting in accordance with Section 22.7.

**22.11.4.9** Means shall be provided to establish the integrity of the secondary containment, in accordance with Chapter 21.

**22.11.4.10** The secondary containment shall be designed to withstand the hydrostatic head resulting from a leak from the primary tank of the maximum amount of liquid that can be stored in the primary tank.

## **22.12 Equipment, Piping, and Fire Protection Systems in Remote Impoundment Areas and Diked Areas.**

**22.12.1\* Location of Piping.** Only piping for product, utility, or fire protection purposes directly connected to a tank or tanks within a single diked area shall be routed through a diked area, a remote impoundment area, a spillway draining to a remote impoundment area, or above a storage tank drainage area where the piping can be exposed to a fire.

*Exception: Piping for other product lines and from adjacent tanks is permitted to be routed through such areas if engineering designs are provided to incorporate features to prevent the piping from creating an exposure hazard.*

### **22.12.2 Drainage.**

**22.12.2.1** Drainage shall be provided to prevent accumulation of any liquid under the piping by providing a slope of not less than 1 percent away from the piping for at least 50 ft (15 m).

**22.12.2.2** Corrosion-resistant piping and piping that is protected against corrosion shall be permitted to be buried where such drainage is not provided.

**22.12.3\* Location of Equipment.** If located in a remote impoundment area, a diked area, or a spillway draining to a remote impoundment area, process equipment, pumps, instrumentation, and electrical utilization equipment shall be located or protected so that a fire involving such equipment does not constitute an exposure hazard to the tank or tanks in the same area for a period of time consistent with emergency response capabilities.

**22.12.4 Fire Protection Systems.** Hose connections, controls, and control valves for application of fire protection foam or water to tanks shall be located outside remote impoundment areas, diked areas, or spillways draining to a remote impoundment area.

**22.12.5 Combustible Materials.** Structures such as stairways, walkways, instrumentation shelters, and supports for piping



and equipment that are located in a remote impoundment area, diked area, or spillway draining to a remote impoundment area shall be constructed of noncombustible materials.

### 22.13 Tank Openings Other Than Vents.

**22.13.1** Each connection to an aboveground tank through which liquid can normally flow shall be provided with an internal or an external valve located as close as practical to the shell of the tank.

**22.13.2** Each connection below the liquid level through which liquid does not normally flow shall be provided with a liquidtight closure such as a valve, plug, or blind, or a combination of these.

**22.13.3** Openings for gauging on tanks storing Class I liquids shall be provided with a vaportight cap or cover.

**22.13.4** Filling and emptying connections for Class I, Class II, and Class IIIA liquids that are connected and disconnected shall be located outside of buildings at a location free from any source of ignition.

**22.13.4.1** Such connections shall be located not less than 5 ft (1.5 m) away from any building opening.

**22.13.4.2** Such connections for any liquid shall be closed and liquidtight when not in use and shall be properly identified.

### 22.14 Aboveground Storage Tanks Located in Areas Subject to Flooding.

**22.14.1** Vertical tanks shall be located so that the tops of the tanks extend above the maximum flood stage by at least 30 percent of their allowable storage capacity.

**22.14.2** Horizontal tanks that are located where more than 70 percent of the tank's storage capacity will be submerged at the established flood stage shall be secured by one of the following methods:

- (1) Anchored to resist movement
- (2) Attached to a foundation of steel and concrete or of concrete having sufficient weight to provide load for the tank when filled with liquid and submerged by flood water to the established flood stage
- (3) Secured from floating by other means

**22.14.3** Tank vents or other openings that are not liquidtight shall extend above the maximum flood stage water level.

**22.14.4** A dependable water supply shall be used for filling an empty or partially filled tank.

*Exception: Where filling the tank with water is impractical or hazardous because of the contents of the tank, the tank should be protected by other means against movement or collapse.*

**22.14.5** Spherical or spheroid tanks shall be protected by any of the methods specified in Section 22.14.

**22.15 Collision Protection for Aboveground Storage Tanks.** Where a tank is exposed to vehicular impact, protection shall be provided to prevent damage to the tank.

**22.16 Installation Instructions for Aboveground Storage Tanks.** Factory-built aboveground tanks shall be provided with instructions for testing the tanks and for installation of the normal and emergency vents.

### 22.17 Inspection and Maintenance of Aboveground Storage Tanks.

**22.17.1** Inspection and maintenance of aboveground tanks shall meet the requirements of Section 21.8.

**22.17.2** Each aboveground steel tank shall be inspected and maintained in accordance with API 653, *Tank Inspection, Repair, Alteration, and Reconstruction*, or STI SP001, *Standard for Inspection of Aboveground Storage Tanks*, whichever is applicable.

**22.17.3** Each tank constructed of materials other than steel shall be inspected and maintained in accordance with manufacturers' instructions and applicable standards.

**22.17.4\*** Pontoons in external floating roof tanks shall be inspected, at intervals not exceeding 5 years, by visual and atmospheric testing methods to ensure that the pontoon covers are mechanically secured to the floating roof deck and to ensure the pontoons do not contain liquids or vapors resulting from leaks or corrosion holes in the pontoons. If liquids, or flammable vapor concentrations at or above 25 percent of the LFL are found, the liquids or vapors shall be safely removed and the source of the leak shall be repaired. The finding of vapors at levels below 25 percent of the LFL shall result either in the implementation of monitoring of the tank pontoons at least annually to assure that vapors in the flammable range are not achieved before corrective action is taken or removal of the tank from service. Rim vents, if any, shall also be inspected to ensure that they are not frozen open.

## Chapter 23 Storage of Liquids in Tanks — Underground Tanks

**23.1 Scope.** This chapter shall apply to the following:

- (1) The storage of flammable and combustible liquids, as defined in 3.3.33 and Chapter 4, in fixed underground tanks
- (2) The installation and operation of underground tanks

### 23.2 Definitions Specific to Chapter 23. (Reserved)

### 23.3 General Requirements.

**23.3.1 Class II and Class III Liquids at Elevated Temperatures.** Storage of Class II and Class III liquids heated at or above their flash point shall follow the requirements for Class I liquids, unless an engineering evaluation conducted in accordance with Chapter 6 justifies following the requirements for some other liquid class.

**23.3.2 Installation.** All underground tanks shall be installed in accordance with the manufacturer's instructions.

**23.3.3 Excavation.** Excavation for underground tanks shall not undermine foundations of existing structures.

**23.3.4\* Care in Handling of Tank.** The tank shall not be damaged during delivery, unloading, and placement into the tank excavation.

**23.3.5\* External Corrosion Protection for Underground Storage Tank.** Underground tanks and their piping shall be protected by either of the following:

- (1) A properly engineered, installed, and maintained cathodic protection system in accordance with recognized engineering standards of design
- (2) Approved or listed corrosion-resistant materials or systems

**23.3.5.1\*** Selection of the type of protection to be employed shall be based upon the corrosion history of the area and the judgment of a qualified engineer.



**23.3.5.2\*** The authority having jurisdiction shall be permitted to waive the requirements for corrosion protection where an engineering evaluation demonstrates that such protection is not necessary.

#### 23.4 Location of Underground Storage Tanks.

**23.4.1** Underground tanks or tanks under buildings shall be located with respect to existing building foundations and supports so that the loads carried by the foundation are not transmitted to the tank.

**23.4.2** The distance from any part of a tank storing Class I liquid to the nearest wall of any basement or pit shall be not less than 1 ft (0.3 m) and to any property line that is or can be built upon shall not be less than 3 ft (0.9 m).

**23.4.3** The distance from any part of a tank storing Class II or Class III liquids to the nearest wall of any basement, pit, or property line that is or can be built upon shall be not less than 1 ft (0.3 m).

#### 23.5 Installation of Underground Storage Tanks.

##### 23.5.1 Bedding and Backfill.

**23.5.1.1** Bedding and backfill shall be noncorrosive inert material of a type recommended by the tank manufacturer, such as compacted clean sand or compacted gravel.

**23.5.1.2** Underground tanks shall be set on firm foundations and shall be set on the minimum depth of bedding recommended by the tank manufacturer. The bedding shall extend at least 12 in. (300 mm) in all directions beyond the perimeter of the tank.

**23.5.1.3** Underground tanks shall be surrounded with backfill to a depth of at least 12 in. (300 mm) or greater where specified by the tank manufacturer. The backfill shall be spread evenly in 12 in. (300 mm) to 18 in. (450 mm) vertical lifts (layers) and shall be compacted as recommended by the manufacturer.

##### 23.5.2 Cover for Underground Storage Tanks.

**23.5.2.1** Underground tanks shall be covered with one of the following:

- (1) At least 12 in. (300 mm) of backfill, covered with 12 in. (300 mm) of clean earth
- (2) At least 12 in. (300 mm) of compacted backfill, on top of which a slab of reinforced concrete at least 4 in. (100 mm) thick is placed

**23.5.2.2** Where the tanks are, or are likely to be, subjected to traffic, they shall be protected against damage from vehicles passing over them by one of the following:

- (1) At least 36 in. (900 mm) of backfill
- (2) At least 18 in. (450 mm) of compacted backfill of a type recommended by the tank manufacturer and at least 6 in. (150 mm) of reinforced concrete
- (3) At least 18 in. (450 mm) of compacted backfill of a type recommended by the tank manufacturer and at least 8 in. (200 mm) of asphaltic concrete

**23.5.2.3** When asphaltic or reinforced concrete paving is used as part of the protection, it shall extend at least 12 in. (300 mm) horizontally beyond the outline of the tank in all directions.

#### 23.5.3 Maximum Burial Depth and Cover.

**23.5.3.1\*** Maximum burial depth shall be specified by the tank manufacturer and shall be marked on the tank.

**23.5.3.2** When the depth of cover is greater than the diameter of the tank or if the pressure at the bottom of the tank can exceed a gauge pressure of 10 psi (69 kPa), the manufacturer of the tank shall be consulted to determine if reinforcement of the tank is required. The specific gravity of the liquid to be stored shall be a design factor.

#### 23.6 Normal Venting for Underground Storage Tanks.

**23.6.1\*** Tank venting systems shall be provided with sufficient capacity to prevent blowback of vapor or liquid at the fill opening while the tank is being filled.

**23.6.2** Vent piping shall be sized in accordance with Table 23.6.2, but shall not be less than 1.25 in. (32 mm) nominal inside diameter.

Table 23.6.2 Nominal Vent Line Diameter in Inches

Maximum Flow (gpm)	Pipe Length*		
	50 ft	100 ft	200 ft
100	1.25	1.25	1.25
200	1.25	1.25	1.25
300	1.25	1.25	1.5
400	1.25	1.5	2
500	1.5	1.5	2
600	1.5	2	2
700	2	2	2
800	2	2	3
900	2	2	3
1000	2	2	3

For SI units, 1 in. = 25 mm; 1 ft = 0.3 m; 1 gal = 3.8 L.

\*Assumes stated length of piping, plus 7 ell.

**23.6.3** Where tank venting devices are installed in vent lines, their flow capacities shall be determined in accordance with 22.7.3.10.

**23.6.4** Piping for normal venting shall be designed in accordance with Chapter 27.

**23.7 Reserved.**

**23.8 Reserved.**

**23.9 Reserved.**

**23.10 Reserved.**

**23.11 Control of Spills from Underground Storage Tanks. (Reserved)**

**23.12 Reserved.**

**23.13 Tank Openings Other than Vents.**

**23.13.1** Connections for all tank openings shall be liquidtight and vaportight.

**23.13.2** Openings for manual gauging, if independent of the fill pipe, shall be provided with a liquidtight and vaportight cap or cover. Covers shall be kept closed when not gauging.

**23.13.2.1** If inside a building, each such opening shall be protected against liquid overflow and possible vapor release by means of a spring-loaded check valve or other approved device.

**23.13.3** Fill and discharge lines shall enter tanks only through the top.

**23.13.4** Fill lines shall be sloped toward the tank.

**23.13.5** Underground tanks for Class I liquids having a capacity of more than 1000 gal (3800 L) shall be equipped with a tight fill device for connecting the fill hose to the tank.

**23.13.6** Filling, emptying, and vapor recovery connections for Class I, Class II, or Class IIIA liquids that are connected and disconnected shall be located outside of buildings at a location free from any source of ignition and not less than 5 ft (1.5 m) from any building opening or air intake.

**23.13.6.1** Such connections shall be closed and liquidtight and vaportight when not in use.

**23.13.6.2** Such connections shall be identified.

**23.13.7** Tank openings provided for purposes of vapor recovery shall be protected against possible vapor release by means of a spring-loaded check valve or dry-break connection, or other approved device, unless the opening is pipe-connected to a vapor processing system.

**23.13.7.1** Openings designed for combined fill and vapor recovery shall also be protected against vapor release unless connection of the liquid delivery line to the fill pipe simultaneously connects the vapor recovery line.

**23.13.7.2** All connections shall be vaportight.

#### **23.14 Underground Storage Tanks Located in Areas Subject to Flooding.**

**23.14.1\*** Tanks shall be anchored or shall be secured by approved means to resist movement when subjected to hydrostatic forces associated with high groundwater or floodwater.

**23.14.1.1** The design of the anchoring or securing method shall be based on the buoyancy of an empty tank that is fully submerged.

**23.14.1.2** Tank vents and other openings that are not liquidtight shall be extended above maximum flood stage water level.

**23.14.1.3** Each tank shall be so constructed and installed that it will safely resist external pressures if submerged.

**23.15 Reserved.**

**23.16 Installation Instructions for Underground Storage Tanks.** Factory-built underground tanks shall be provided with instructions for testing and for installation of the normal vents.

#### **23.17 Inspection and Maintenance of Underground Storage Tanks.**

**23.17.1** Inspection and maintenance for underground tanks shall meet the requirements of Section 21.8.

**23.17.2** Overfill protection devices or systems shall be inspected and tested annually to ensure proper operation.

## **Chapter 24 Storage Tank Buildings**

### **24.1\* Scope.**

**24.1.1** This chapter shall apply to installations of tanks storing Class I, Class II, and Class IIIA liquids in storage tank buildings.

**24.1.2** This chapter shall also apply to installations of above-ground storage tanks storing Class II, Class IIIA, or Class IIIB liquids in storage tank buildings where the liquids are heated at or above their flash points. In such cases, the liquids shall be regulated as Class I liquids unless an engineering evaluation conducted in accordance with Chapter 6 justifies following the requirements for some other liquid class.

**24.1.3** This chapter shall not apply to the following:

- (1) Tanks covered by Chapters 17, 18, and 19.
- (2) A tank that has a canopy or roof that does not limit the dissipation of heat or dispersion of flammable vapors and does not restrict fire-fighting access and control. Such tanks shall comply with the provisions of Chapter 22.

### **24.2 Definitions Specific to Chapter 24. (Reserved)**

### **24.3 General Requirements. (Reserved)**

#### **24.3.1 Reserved.**

### **24.4 Location of Storage Tank Buildings.**

**24.4.1** Tanks and associated equipment within the storage tank building shall be so located that a fire in the area shall not constitute an exposure hazard to adjoining buildings or tanks for a period of time consistent with the response and suppression capabilities of the fire-fighting operations available to the location. Compliance with 24.4.2 through 24.4.8 shall be deemed as meeting the requirements of 24.4.1.

**24.4.2** The minimum distance from exposed property lines and buildings for tank installations within structures having walls with a fire resistance rating of less than 2 hours shall be in accordance with Table 24.4.2.

**24.4.3** The capacity of any individual tank shall not exceed 100,000 gal (380 m<sup>3</sup>) without the approval of the authority having jurisdiction.

**24.4.4** Where protection for exposures is not provided, the distances given in Table 24.4.2 shall be doubled. The distances shall not be required to exceed 300 ft (90 m).

**24.4.5** Where a storage tank building has an exterior wall facing an exposure, the distances in Table 24.4.2 shall be permitted to be modified as follows:

- (1) Where the wall is a blank wall having a fire resistance rating of not less than 2 hours, separation distance between the storage tank building and its exposure shall not be required to be greater than 25 ft (7.6 m).
- (2) Where a blank wall having a fire resistance rating of not less than 4 hours is provided, the distance requirements of Table 24.4.2 shall not apply.
- (3)\*Where Class IA liquids or unstable liquids are stored, the exposing wall shall have explosion resistance in accordance with recognized engineering standards, and deflagration venting designed in accordance with NFPA 68, *Standard on Explosion Protection by Deflagration Venting*, shall be provided in the nonexposing walls and roof.



**Table 24.4.2 Location of Storage Tank Buildings with Respect to Property Lines, Public Ways, and the Nearest Important Building on the Same Property**

Largest Tank — Operating Liquid Capacity (gal)	Minimum Distance from Property Line that Is or Can Be Built Upon, Including Opposite Side of Public Way (ft)				Minimum Distance from Nearest Side of Any Public Way or from Nearest Important Building on Same Property (ft)			
	Stable Liquid Emergency Relief		Unstable Liquid Emergency Relief		Stable Liquid Emergency Relief		Unstable Liquid Emergency Relief	
	Not over 2.5 psi	Over 2.5 psi	Not over 2.5 psi	Over 2.5 psi	Not over 2.5 psi	Over 2.5 psi	Not over 2.5 psi	Over 2.5 psi
Up to 12,000	15	25	40	60	5	10	15	20
12,001 to 30,000	20	30	50	80	5	10	15	20
30,001 to 50,000	30	45	75	120	10	15	25	40
50,001 to 100,000	50	75	125	200	15	25	40	60

For SI units, 1 gal = 3.8 L; 1 ft = 0.3 m; 1 psi = 6.9 kPa.

**24.4.6** Other equipment associated with tanks, such as pumps, heaters, filters, and exchangers, shall not be located closer than 25 ft (7.6 m) to property lines where the adjoining property is or can be built upon or to the nearest important building on the same property that is not an integral part of the storage tank building. This spacing requirement shall not apply where exposures are protected as outlined in 24.4.2.

**24.4.7** Tanks in which unstable liquids are stored shall be separated from potential fire exposures by a clear space of at least 25 ft (7.6 m) or by a wall having a fire resistance rating of not less than 2 hours.

**24.4.8** Each storage tank building and each tank within the building shall be accessible from at least two sides for fire fighting and fire control.

**24.4.9** Class I liquids and Class II or Class IIIA liquids heated above their flash points shall not be stored in basements.

#### **24.5 Construction of Storage Tank Buildings.**

**24.5.1** Storage tank buildings shall be constructed so as to maintain structural integrity for 2 hours under fire exposure conditions and to provide access and egress for unobstructed movement of all personnel and fire protection equipment. Compliance with 24.5.2 through 24.5.7 shall be deemed as meeting the requirements of 24.5.1.

**24.5.2\*** Buildings or structures shall be of at least 2-hour fire resistance rating.

**24.5.2.1** Noncombustible or combustible construction shall be permitted when protected by automatic sprinklers or equivalent protection subject to the approval of the authority having jurisdiction.

**24.5.3** Where Class I liquids are stored above grade within buildings with basements or other belowgrade areas into which flammable vapors can travel, such belowgrade areas shall be provided with mechanical ventilation designed to prevent the accumulation of flammable vapors. Enclosed storage tank pits shall not be considered basements.

**24.5.4\*** Storage tank buildings where Class IA liquids are stored shall be designed to direct flame, combustion gases, and pressure resulting from an deflagration away from important buildings or occupied areas through the use of damage-

limiting construction. The damage-limiting construction design shall be in accordance with NFPA 68, *Standard on Explosion Protection by Deflagration Venting*, and shall be acceptable to the authority having jurisdiction.

**24.5.5** Storage tank buildings where unstable liquids are stored shall be designed using an approved engineered construction method that is intended to limit damage from an explosion (deflagration or detonation, depending on the liquid).

**24.5.6\*** Access aisles not less than 3 ft (0.9 m) in width shall be provided and maintained from the exterior of the storage tank building into the building and around all storage tanks.

**24.5.7** A clear space of at least 3 ft (0.9 m) shall be maintained between the top of each tank and the building structure for buildings protected in accordance with 24.6.2.3. For buildings without fixed fire suppression systems, sufficient clear space shall be provided to allow for the application of hose streams to the top of the tank(s) for cooling purposes.

#### **24.6 Fire Protection for Storage Tank Buildings.**

##### **24.6.1 Manual Fire Control Equipment for Storage Tank Buildings.**

**24.6.1.1\*** Listed portable fire extinguishers shall be provided for facilities in such quantities, sizes, and types as could be needed for special storage hazards as determined in accordance with 21.6.1.2.

**24.6.1.2\*** Where the need is indicated in accordance with 21.6.3, water shall be utilized through standpipe and hose systems, or through hose connections from sprinkler systems using combination spray and straight stream nozzles to permit effective fire control.

**24.6.1.3** Where the need is indicated in accordance with 21.6.3, mobile foam apparatus shall be provided.

##### **24.6.2 Fixed Fire Control Equipment for Tank Buildings.**

**24.6.2.1** A reliable water supply or other suitable fire control agent shall be available in pressure and quantity to meet the fire demands indicated by special storage hazards or exposure as determined by 21.6.3.

**24.6.2.2\*** Hydrants, with or without fixed monitor nozzles, shall be provided in accordance with accepted practice. The number and placement shall depend on the hazard of the storage, or exposure, as determined by 21.6.3.

**24.6.2.3\*** Where the need is indicated by the hazards of storage or exposure as determined by 21.6.3, fixed protection shall be required utilizing approved foam, foam-water sprinkler systems, sprinkler systems, water spray systems, deluge systems, gaseous extinguishing systems, dry chemical extinguishing systems, fire-resistive materials, or a combination of these.

**24.6.2.3.1** When foam or foam-water fire protection systems are provided, discharge densities shall be determined based on the listing criteria for selected foam discharge devices, the foam concentrate, and the specific flammable or combustible liquids to be protected.

**24.6.2.4** If provided, fire control systems shall be designed, installed, and maintained in accordance with the following NFPA standards:

- (1) NFPA 11, *Standard for Low-, Medium-, and High-Expansion Foam*
- (2) NFPA 12, *Standard on Carbon Dioxide Extinguishing Systems*
- (3) NFPA 12A, *Standard on Halon 1301 Fire Extinguishing Systems*
- (4) NFPA 13, *Standard for the Installation of Sprinkler Systems*
- (5) NFPA 15, *Standard for Water Spray Fixed Systems for Fire Protection*
- (6) NFPA 16, *Standard for the Installation of Foam-Water Sprinkler and Foam-Water Spray Systems*
- (7) NFPA 17, *Standard for Dry Chemical Extinguishing Systems*
- (8) NFPA 25, *Standard for the Inspection, Testing, and Maintenance of Water-Based Fire Protection Systems*

#### **24.7 Emergency Control Systems for Storage Tank Buildings. (Reserved)**

#### **24.8 Electrical Systems for Storage Tank Buildings.**

**24.8.1** Installation of electrical utilization equipment and wiring shall meet the requirements of Chapter 7.

**24.8.2** Chapter 7 shall be used to determine the extent of classified locations for the purpose of installation of electrical equipment.

**24.8.2.1** In establishing the extent of a classified location, it shall not extend beyond a floor, wall, roof, or other solid partition that has no openings within the classified area.

#### **24.9 Containment, Drainage, and Spill Control from Storage Tank Buildings.**

**24.9.1** Drainage systems shall be designed to minimize fire exposure to other tanks and adjacent properties or waterways. Compliance with 24.9.2 through 24.9.6 shall be deemed as meeting the requirements of 24.9.1.

**24.9.2** The facility shall be designed and operated to prevent the discharge of flammable or combustible liquids to public waterways, public sewers, or adjoining property under normal operating conditions.

**24.9.3** Except for drains, solid floors shall be liquidtight and walls shall be liquidtight where they join the floor and for at least 4 in. (100 mm) above the floor.

**24.9.4** Openings to adjacent rooms or buildings shall be provided with noncombustible, liquidtight raised sills or ramps at

least 4 in. (100 mm) in height or shall be otherwise designed to prevent the flow of liquids to the adjoining areas.

**24.9.4.1** An open-grated trench across the width of the opening inside of the room that drains to a safe location shall be permitted to be used as an alternative to a sill or ramp.

**24.9.5** Means shall be provided to prevent liquid spills from running into basements.

**24.9.6\*** The containment shall have a capacity not less than that of the largest tank that can drain into it.

**24.9.7** Emergency drainage systems shall be provided to direct flammable or combustible liquid leakage and fire-protection water to a safe location.

**24.9.8** Curbs, scuppers, or special drainage systems shall be permitted to be used.

**24.9.9** Emergency drainage systems, if connected to public sewers or discharged into public waterways, shall be equipped with traps or separators.

#### **24.10 Ventilation for Storage Tank Buildings.**

**24.10.1** Storage tank buildings storing Class I liquids or Class II or Class III liquids at temperatures at or above their flash points shall be ventilated at a rate sufficient to maintain the concentration of vapors within the building at or below 25 percent of the lower flammable limit. Compliance with 24.10.2 through 24.10.7 shall be deemed as meeting the requirements of 24.10.1.

**24.10.2\*** Ventilation shall be designed based on one of the following:

- (1) Calculations based on the anticipated fugitive emissions (*See Annex F for calculation methods.*)
- (2) Sampling of the actual vapor concentration under normal operating conditions
- (3) Ventilation at a rate of not less than 1 cfm of exhaust air for each square foot of solid floor area ( $0.3 \text{ m}^3/\text{min}/\text{m}^2$ )

**24.10.2.1** If vapor concentrations are confirmed by sampling, the sampling shall be conducted at a distance of a 5 ft (1.5 m) radius from each potential vapor source extending to or toward the bottom and the top of the enclosed storage area. The vapor concentration used to determine the required ventilation rate shall be the highest measured concentration during the sampling procedure.

**24.10.3** Ventilation shall be accomplished by natural or mechanical ventilation, with discharge or exhaust to a safe location outside the building.

**24.10.3.1** Recirculation of exhaust air shall be permitted only when it is monitored continuously using a fail-safe system that is designed to automatically sound an alarm, stop recirculation, and provide full exhaust to the outside in the event that vapor-air mixtures having concentrations over 25 percent of the lower flammable limit are detected.

**24.10.4\*** Provision shall be made for introduction of make-up air in such a manner as to avoid short-circuiting the ventilation.

**24.10.5** Ventilation shall be arranged to include all floor areas or pits where flammable vapors can collect.

**24.10.6** Where natural ventilation is inadequate, mechanical ventilation shall be provided and shall be kept in operation while flammable liquids are being handled.



**24.10.6.1** Local or spot ventilation, if provided, shall be permitted to be used for up to 75 percent of the required ventilation.

**24.10.7** Storage tank buildings with the interior grade more than 12 in. (300 mm) below the average exterior grade shall be provided with one of the following:

- (1) Continuous mechanical ventilation in accordance with 24.10.2(3)
- (2) A vapor detection system set to sound a warning alarm at a constantly attended location at 25 percent of the lower flammable limit, and to start the mechanical ventilation system

**24.11 Reserved.**

**24.12 Explosion Control. (Reserved)**

**24.13 Vents for Tanks Inside Storage Tank Buildings.**

**24.13.1** Vents for tanks inside tank buildings shall be designed to ensure that vapors are not released inside the building. Compliance with 24.13.2 through 24.13.6 shall be deemed as meeting the requirements of 24.13.1.

**24.13.2** Vents for tanks inside tank buildings shall be as required in 21.4.3 and Section 22.7.

**24.13.3** Emergency venting by the use of a weak roof-to-shell seam shall not be permitted.

**24.13.4** Automatic sprinkler systems designed in accordance with the requirements of NFPA 13, *Standard for the Installation of Sprinkler Systems*, shall be accepted by the authority having jurisdiction as equivalent to water spray systems for purposes of calculating the required airflow rates for emergency vents in 22.7.3.5, provided the density and coverage requirements of NFPA 15, *Standard for Water Spray Fixed Systems for Fire Protection*, are met.

**24.13.5** Vents shall terminate outside the building in accordance with 27.8.1.

**24.13.5.1** Emergency relief vents on protected aboveground tanks complying with UL 2085 containing Class II and Class III liquids shall be allowed to discharge inside the building.

**24.13.6** Piping for normal and emergency relief venting shall meet the requirements of Chapter 27.

**24.14 Tank Openings Other than Vents for Tanks Inside Storage Tank Buildings.**

**24.14.1** Tank openings other than vents for tanks inside tank buildings shall be designed to ensure that flammable liquids or vapors are not released inside the building. Compliance with 24.14.2 through 24.14.9 shall be deemed as meeting the requirements of 24.14.1.

**24.14.2** All tank openings that are located at or below the maximum liquid level shall be liquidtight. Those that are located above the maximum liquid level shall be normally closed and shall be mechanically secured to prevent release of vapors.

**24.14.3** Each liquid transfer connection on any tank storing Class I or Class II liquids inside buildings shall be provided with one of the following:

- (1) A normally closed, remotely activated valve
- (2) An automatic-closing, heat-activated valve
- (3) Another approved device

**24.14.4** Connections used for emergency disposal or to provide for quick cutoff of flow in the event of fire in the vicinity of the tank shall not be required to meet the requirement of 24.14.3.

**24.14.5** Each connection through which liquid can gravity flow from a tank inside a building shall be provided with an internal or an external valve located as close as practical to the shell of the tank. This valve shall be considered to be in compliance with 24.14.3. If a separate valve is used, both valves shall be located adjacent to each other.

**24.14.6\*** Openings for manual gauging of Class I or Class II liquids, if independent of the fill pipe, shall be provided with a vaportight cap or cover that shall be kept closed when not in use.

**24.14.6.1** Each such opening for any liquid shall be protected against liquid overflow and possible vapor release by means of a spring-loaded check valve or other approved device.

**24.14.7** The inlet of the fill pipe and the outlet of a vapor recovery line for which connections to tank vehicles and tank cars are made and broken shall be as follows:

- (1) Located outside of buildings at a location free from any source of ignition
- (2) Located not less than 5 ft (1.5 m) away from any building opening
- (3) Closed tight and protected against tampering when not in use
- (4) Identified

**24.14.8\*** Tanks storing Class I, Class II, or Class IIIA liquids inside buildings shall be equipped with a device, or other means shall be provided, to prevent overflow into the building.

**24.14.9** Tank openings provided for purposes of vapor recovery shall be protected against possible vapor release by means of a spring-loaded check valve or dry-break connection or other approved device, unless the opening is pipe-connected to a vapor processing system.

**24.14.9.1** Openings designed for combined fill and vapor recovery shall also be protected against vapor release unless connection of the liquid delivery line to the fill pipe simultaneously connects the vapor recovery line.

**24.14.9.2** All connections shall be vaportight.

**24.15 Detection and Alarm Systems for Storage Tank Buildings.**

**24.15.1** An approved means shall be provided to promptly notify those within the plant and the available public or mutual aid fire department of any fire or other emergency.

**24.15.2** Those areas, including buildings, where the potential exists for a flammable liquid spill shall be monitored as appropriate. Such methods shall include both of the following:

- (1) Personnel observation or patrol
- (2) Monitoring equipment that indicates a spill or leak has occurred in an unattended area

**24.16 Inspection and Maintenance for Storage Tank Buildings.**

**24.16.1** Combustible waste material and residues in operating areas shall be kept to a minimum, stored in covered metal containers, and disposed of daily.

**24.16.2** Storage of combustible materials and empty or full drums or barrels shall not be permitted within the storage tank building.

## Chapter 25 Storage Tank Vaults

**25.1 Scope.** This chapter shall apply to the design, construction, and installation of vaults for aboveground tanks.

**25.2 Definitions Specific to Chapter 25. (Reserved)**

**25.3 General Requirements.**

**25.3.1\* Storage Tank Selection and Arrangement.**

**25.3.1.1** Aboveground tanks shall be permitted to be installed in vaults that meet the requirements of this chapter.

**25.3.1.2** Vaults shall be constructed and listed in accordance with UL 2245, *Standard for Below-Grade Vaults for Flammable Liquid Storage Tanks*.

**25.3.1.3** Except as modified by the provisions of this chapter, vaults shall meet all other applicable provisions of this code.

**25.3.1.4** Tanks installed in storage tank vaults shall be listed for aboveground use.

**25.3.1.5** Each tank shall be in its own vault and shall be completely enclosed by the vault.

**25.3.1.6** Sufficient clearance between the tank and the vault shall be provided to allow for visual inspection and maintenance of the tank and its appurtenances.

**25.3.1.7** Backfill shall not be permitted around the tank.

**25.3.1.8** Dispensing devices shall be permitted to be installed on the tops of vaults. Dispensing devices used for motor fuels shall be installed in accordance with NFPA 30A, *Code for Motor Fuel Dispensing Facilities and Repair Garages*.

**25.3.1.9** At each entry point into the vault, a warning sign indicating the need for procedures for safe entry into confined spaces shall be posted. Each entry point shall be secured against unauthorized entry and vandalism.

**25.3.2 Storage Tank Appurtenances.**

**25.3.2.1** An approved means of overfill protection shall be provided for the tanks in the vaults. The use of ball float valves shall be prohibited.

**25.3.2.2** Fill connections for vaults installed inside buildings shall comply with 22.13.4.

**25.3.3 Vault Arrangement.**

**25.3.3.1** Vaults shall be permitted to be either above or below grade.

**25.4 Location of Storage Tank Vaults.** In lieu of the separation distance requirements given in Section 22.4, separation distances between the vault and any of the following shall be permitted to be reduced to 0 ft (0 m), as measured from the outer perimeter of the vault wall:

- (1) Any property line that is or can be built upon
- (2) The near and far sides of a public way
- (3) The nearest important building on the same property

**25.5\* Construction and Installation of Storage Tank Vaults.**

**25.5.1 Construction Requirements.** Vaults shall be designed and constructed in accordance with 25.5.1.1 through 25.5.1.4.

**25.5.1.1** The top of an abovegrade vault that contains a tank storing Class I liquid or Class II liquid stored at a temperature above its flash point shall be constructed of noncombustible

material and shall be designed to be weaker than the walls of the vault to ensure that the thrust of any explosion occurring inside the vault is directed upward before destructive internal pressure develops within the vault.

**25.5.1.2** The top of an at-grade or belowgrade vault that contains a tank storing Class I liquid or Class II liquid stored at a temperature above its flash point shall be designed to relieve or contain the force of any explosion occurring inside the vault.

**25.5.1.3** Adjacent vaults shall be permitted to share a common wall.

**25.5.1.4** Where required, the vault shall be wind and earthquake resistant, in accordance with recognized engineering standards.

**25.5.2 Installation Requirements.** Storage tank vaults shall be installed in accordance with the requirements of 25.5.2.1 and 25.5.2.2.

**25.5.2.1** Each vault and its tank shall be anchored to resist uplifting by groundwater or flooding, including when the tank is empty.

**25.5.2.2** Vaults that are not resistant to damage from the impact of a motor vehicle shall be protected by collision barriers.

**25.6 Fire Protection for Storage Tank Vaults.** Each vault shall be provided with means to admit a fire suppression agent.

**25.7 Emergency Controls for Storage Tank Vaults. (Reserved)**

**25.8 Electrical Systems for Storage Tank Vaults.**

**25.8.1** Installation of electrical utilization equipment and wiring shall meet the requirements of Chapter 7.

**25.8.2** Chapter 7 shall be used to determine the extent of classified locations for the purpose of installation of electrical equipment.

**25.9 Containment, Drainage, and Spill Control for Storage Tank Vaults.**

**25.9.1** Means shall be provided to recover liquid from the vault.

**25.9.2** If a pump is used to meet this requirement, the pump shall not be permanently installed in the vault.

**25.9.3** Electric-powered portable pumps shall be approved for use in Class I, Division 1 locations, as defined in *NFPA 70, National Electrical Code*.

**25.10 Ventilation Systems for Storage Tank Vaults.**

**25.10.1** Vaults that contain tanks storing Class I liquids shall be ventilated at a rate of not less than 1 cfm/ft<sup>2</sup> of floor area (0.3 m<sup>3</sup>/min/m<sup>2</sup>), but not less than 150 cfm (4 m<sup>3</sup>/min).

**25.10.2** Such ventilation shall operate continuously or shall be designed to operate upon activation of a vapor and liquid detection system.

**25.10.3** Failure of the exhaust airflow shall automatically shut down the dispensing system.

**25.10.4** The exhaust system shall be designed to provide air movement across all parts of the vault floor.

**25.10.5** Supply and exhaust ducts shall extend to within 3 in. (75 mm), but not more than 12 in. (300 mm) of the floor.



**25.10.6** The exhaust system shall be installed in accordance with the provisions of NFPA 91, *Standard for Exhaust Systems for Air Conveying of Vapors, Gases, Mists, and Noncombustible Particulate Solids*.

**25.11 Reserved.**

**25.12 Explosion Control. (Reserved)**

**25.13 Vents for Tanks Inside Storage Tank Vaults.**

**25.13.1** Vent pipes that are provided for normal tank venting shall terminate outside the vault and at least 12 ft (3.6 m) above ground level and shall meet the requirements of 27.8.1.

**25.13.2** Emergency vents shall be vaportight and shall be permitted to discharge inside the vault. Long-bolt manhole covers shall not be permitted for this purpose.

**25.14 Tank Openings Other than Vents for Tanks Inside Storage Tank Vaults. (Reserved)**

**25.15 Detection and Alarm Systems for Storage Tank Vaults.**

**25.15.1** Each vault shall be provided with an approved vapor and liquid detection system that is equipped with on-site audible and visual warning devices with battery backup.

**25.15.2** The vapor detection system shall sound an alarm when the system detects vapors that reach or exceed 25 percent of the lower flammable limit of the liquid stored.

**25.15.3** Vapor detectors shall be located no higher than 12 in. (300 mm) above the lowest point in the vault.

**25.15.4** The liquid detection system shall sound an alarm upon detection of any liquid, including water.

**25.15.5** Liquid detectors shall be located in accordance with the manufacturer's instructions.

**25.15.6** Activation of either the vapor detection system or the liquid detection system shall cause a signal to be sounded at an approved, constantly attended location within the facility serving the tanks or at an approved location.

**25.16 Inspection and Maintenance of Storage Tank Vaults and Equipment.** Vaults and their required equipment shall be maintained in accordance with the requirements of this chapter.

## Chapter 26 Reserved

## Chapter 27 Piping Systems

### 27.1 Scope.

**27.1.1** This chapter shall apply to the design, installation, testing, operation, and maintenance of piping systems for flammable and combustible liquids or vapors. Such piping systems shall include but not be limited to pipe, tubing, flanges, bolting, gaskets, valves, fittings, flexible connectors, the pressure-containing parts of other components including but not limited to expansion joints and strainers, and devices that serve such purposes as mixing, separating, snubbing, distributing, metering, control of flow, or secondary containment.

**27.1.2** This chapter shall not apply to any of the following:

- (1) Tubing or casing on any oil or gas wells and any piping connected directly thereto
- (2) Motor vehicles, aircraft, boats, or piping that is integral to a stationary engine assembly
- (3) Piping within the scope of any applicable boiler and pressure vessel code

**27.2 Definitions Specific to Chapter 27.** For the purpose of this chapter, terms in this section shall have the definitions given.

**27.2.1 Corrosion Protection.** A means to lessen or prevent the deterioration of the piping system from exposure to its contents or its environment.

**27.2.2 Flexible Connector.** A connection joint in a piping system that allows differential movement of the piping system and limits system stress and mechanical damage.

**27.2.3 Leak.** An unintended release of liquid or vapor from the piping system due to failure of the piping system.

**27.2.4 Low Melting Point Materials.** Materials that melt at a low temperature, including but not limited to aluminum, copper, or brass; materials that soften on fire exposure, such as plastics; or nonductile materials, such as cast iron.

**27.2.5 Secondary Containment.** Containment that is external to and separate from the primary piping system.

### 27.3 General Requirements.

**27.3.1 Performance Standards.** The design, fabrication, assembly, test, and inspection of piping systems shall be suitable for the working pressures and structural stresses to be encountered by the piping system. Compliance with applicable sections of ASME B31, *Code for Pressure Piping*, and the provisions of this chapter shall be considered *prima facie* evidence of compliance with the foregoing provisions.

**27.3.2 Tightness of Piping.** Piping systems shall be maintained liquidtight. A piping system that has leaks that constitute a hazard shall be repaired in a manner acceptable to the authority having jurisdiction, or it shall be emptied of liquid, vapor freed, and no longer be used.

### 27.4 Materials of Construction for Piping Systems.

**27.4.1 Materials Specifications.** Pipe, valves, faucets, couplings, flexible connectors, fittings, and other pressure-containing parts shall meet the material specifications and pressure and temperature limitations of ASME B31, *Code for Pressure Piping*, except as provided for in 27.4.2, 27.4.3, and 27.4.4.

**27.4.2 Ductile Iron.** Ductile (nodular) iron shall meet the specifications of ASTM A 395, *Standard Specification for Ferritic Ductile Iron Pressure-Retaining Castings for Use at Elevated Temperatures*.

**27.4.3 Materials of Construction for Valves.** Valves at storage tanks, as required by Sections 22.13 and 24.14, and their connections to the tank shall be of steel or ductile iron, except as provided for in 27.4.3.1, 27.4.3.2, or 27.4.4.

**27.4.3.1** Valves at storage tanks shall be permitted to be other than steel or ductile iron where the chemical characteristics of the liquid stored are not compatible with steel or where the valves are installed internally to the tank.

**27.4.3.2\*** Valves installed externally to the tank shall be permitted to be other than steel or ductile iron if the material of



construction has a ductility and melting point comparable to steel or ductile iron and is capable of withstanding the stresses and temperatures involved in fire exposure or the valves are otherwise protected from fire exposures, such as by materials having a fire resistance rating of not less than 2 hours.

**27.4.3.3** Cast iron, brass, copper, aluminum, malleable iron, and similar materials shall be permitted to be used on tanks described in 27.4.2.1.1 or on tanks storing Class IIIB liquids where the tanks are located outdoors and not within a diked area or drainage path of a tank storing a Class I, Class II, or Class IIIA liquid.

#### **27.4.4 Low Melting Point Materials.**

**27.4.4.1** Low melting point materials, as defined in 27.2.4, shall be compatible with the liquids being handled and shall be used within the pressure and temperature limitations of ASME B31, *Code for Pressure Piping*.

**27.4.4.2** Low melting point materials shall not be used as part of a tank's normal or emergency vent piping.

**27.4.4.3** Low melting point materials shall be permitted to be used underground.

**27.4.4.4** Low melting point materials shall be permitted to be used outdoors aboveground, outside a dike, outside a remote impounding area, or inside buildings, provided they meet one of the following conditions:

- (1) They are resistant to damage by fire.
- (2) They are located so that any leakage resulting from failure will not expose persons, important buildings, tanks, or structures.
- (3) They are located where leakage can be controlled by operation of one or more accessible, remotely located valves.

**27.4.4.5** Low melting point materials shall be permitted to be used within a dike or within a remote impounding area, provided they meet one of the following:

- (1) They are connected above the normal operating liquid level of the tank.
- (2) They are connected below the normal operating liquid level of the tank and one of the following conditions is met:
  - (a) The stored liquid is a Class IIIB liquid, the tank is located outdoors, and the piping is not exposed to a potential spill or leak of Class I, Class II, or Class IIIA liquid.
  - (b) The low melting point material is protected from fire exposure, such as by using materials that have a fire resistance rating of not less than 2 hours.

**27.4.4.6** Piping systems of these materials shall be designed and built in accordance with recognized standards of design for the particular materials chosen or with approved equivalent standards or shall be listed.

**27.4.5 Lining Materials.** Piping, valves, and fittings shall be permitted to have combustible or noncombustible linings.

#### **27.4.6 Nonmetallic Piping.**

**27.4.6.1** Piping systems of nonmetallic materials, including piping systems incorporating secondary containment, shall be designed and built in accordance with recognized standards of design or approved equivalents and shall be installed in accordance with 27.4.4.

**27.4.6.2** Nonmetallic piping shall be built and used within the scope of their approvals or within the scope of UL 971, *Standard for Nonmetallic Underground Piping for Flammable Liquids*.

**27.4.6.3** Nonmetallic piping systems and components shall be installed in accordance with manufacturer's instructions.

#### **27.5 Pipe Joints.**

##### **27.5.1 Tightness of Pipe Joints.**

**27.5.1.1** Joints shall be made liquidtight and shall be welded, flanged, threaded, or mechanically attached.

**27.5.1.2\*** Joints shall be designed and installed so that the mechanical strength of the joint will not be impaired if exposed to a fire.

**27.5.1.3** Threaded joints shall be made with a suitable thread sealant or lubricant.

**27.5.1.4** Joints in piping systems handling Class I liquids shall be welded when located in concealed spaces within buildings.

**27.5.2 Flexible Connectors.** Listed flexible connectors shall be permitted to be used where installed in accordance with 27.5.3.

##### **27.5.3 Friction Joints.**

**27.5.3.1** Pipe joints dependent upon the friction characteristics of combustible materials for mechanical continuity or liquidtightness of piping shall only be used outside of buildings above ground, except as provided for in 27.5.3.3, or below ground.

**27.5.3.2** Where such joints are used aboveground, either the piping shall be secured to prevent disengagement at the fitting or the piping system shall be so designed that any spill or leak resulting from disengagement will not expose persons, important buildings, or structures and can be controlled by remote valves.

**27.5.3.3** Pipe joints dependent on the friction characteristics of their components shall be permitted to be used inside buildings provided both of the following are met:

- (1) They are located where leakage can be controlled by operation of an accessible, remotely located valve that is outside the fire risk area.
- (2) The mechanical strength and liquidtightness of the joint is not dependent on the resiliency of a combustible material or component.

#### **27.6 Installation of Piping Systems.**

**27.6.1 General Requirements.** Piping systems shall be supported and protected against physical damage, including damage from stresses arising from settlement, vibration, expansion, or contraction. The installation of nonmetallic piping shall be in accordance with the manufacturer's instructions.

**27.6.2\* Load-Bearing Supports.** Load-bearing piping supports that are located in areas with a high fire exposure risk shall be protected by one or more of the following:

- (1) Drainage to a safe location to prevent liquid from accumulating under pipeways
- (2) Fire-resistive construction
- (3) Fire-resistant protective coatings or systems



- (4) Water spray systems designed and installed in accordance with NFPA 15, *Standard for Water Spray Fixed Systems for Fire Protection*
- (5) Other alternate means acceptable to the authority having jurisdiction

**27.6.3 Pipe Penetrations.** Piping that passes through or pierces a dike wall or the wall of a structure shall be designed to prevent damaging stresses and leakage due to settlement or fire exposure.

**27.6.4\* Corrosion Protection.** Aboveground piping systems that are subject to external corrosion shall be suitably protected. Underground piping systems shall be protected against corrosion in accordance with Section 23.3.5.

#### 27.6.5 Installation of Underground Piping.

**27.6.5.1** Underground piping shall be installed on at least 6 in. (150 mm) of well-compacted bedding material.

**27.6.5.2** In areas subject to vehicle traffic, the pipe trench shall be deep enough to permit a cover of at least 18 in. (450 mm) of well-compacted backfill material and pavement.

**27.6.5.3** In paved areas where a minimum 2 in. (50 mm) of asphalt is used, backfill between the pipe and the asphalt shall be permitted to be reduced to 8 in. (200 mm) minimum.

**27.6.5.4** In paved areas where a minimum 4 in. (100 mm) of reinforced concrete is used, backfill between the pipe and the asphalt shall be permitted to be reduced to 4 in. (100 mm) minimum.

**27.6.5.5** In areas not subject to vehicle traffic, the pipe trench shall be deep enough to permit a cover of at least 6 in. (150 mm) of well-compacted backfill material.

**27.6.5.6** A greater burial depth shall be provided when required by the manufacturer's instructions or where frost conditions are present.

**27.6.5.7** Piping within the same trench shall be separated horizontally by at least two pipe diameters. Separation need not exceed 9 in. (230 mm).

**27.6.5.8** Two or more levels of piping within the same trench shall be separated vertically by a minimum 6 in. (150 mm) of well-compacted bedding material.

#### 27.6.6 Valves.

**27.6.6.1** Piping systems shall contain valves to operate the system properly and to isolate the equipment in the event of an emergency.

**27.6.6.2** Piping systems in connection with pumps shall contain valves to properly control the flow of liquid both in normal operation and in the event of an emergency.

**27.6.6.3** Each connection to a piping system by which equipment such as tank cars, tank vehicles, or marine vessels discharges liquids into storage tanks shall be provided with a check valve for automatic protection against back flow if the piping arrangement is such that backflow from the system is possible. (See also 22.13.1.)

**27.6.7 Common Loading and Unloading Piping.** If loading and unloading is done through a common pipe system, a check valve shall not be required. However, an isolation valve shall be provided. This valve shall be located so that it is accessible or shall be remotely operable.

#### 27.7 Testing of Piping Systems.

**27.7.1 Initial Testing.** Unless tested in accordance with the applicable sections of ASME B31, *Code for Pressure Piping*, all piping shall be tested before being covered, enclosed, or placed in use.

**27.7.1.1** Testing shall be done hydrostatically to 150 percent of the maximum anticipated pressure of the system or pneumatically to 110 percent of the maximum anticipated pressure of the system, and the test pressure shall be maintained while a complete visual inspection of all joints and connections is conducted.

**27.7.1.2** In no case shall the test pressure be less than a gauge pressure of 5 psi (35 kPa) measured at the highest point of the system, and in no case shall the test pressure be maintained for less than 10 minutes.

**27.7.2 Initial Testing of Secondary Containment Piping.** The interstitial space of secondary containment-type piping shall be tested hydrostatically or with air pressure at a gauge pressure of 5 psi (35 kPa) or shall be tested in accordance with its listing or with the manufacturer's instructions.

**27.7.2.1** The pressure source shall be disconnected from the interstitial space to ensure that the test is being conducted on a closed system.

**27.7.2.2** The pressure shall be maintained for a minimum of 1 hour.

**27.7.3 Testing During Maintenance.** Existing piping shall be tested in accordance with this subsection if the piping is leaking.

**27.7.3.1** Piping that could contain a Class I, Class II, or Class IIIA liquid or vapor shall not be tested using air.

**27.8 Vent Piping.** Vent piping shall be designed, constructed, and installed in accordance with this section.

#### 27.8.1 Vent Piping for Aboveground Storage Tanks.

**27.8.1.1** Where the outlets of vent pipes for tanks storing Class I liquids are adjacent to buildings or public ways, they shall be located so that vapors are released at a safe point outside of buildings and not less than 12 ft (3.6 m) above the adjacent ground level.

**27.8.1.2** Vapors shall be discharged upward or horizontally away from adjacent walls.

**27.8.1.3** Vent outlets shall be located so that vapors will not be trapped by eaves or other obstructions and shall be at least 5 ft (1.5 m) from building openings and at least 15 ft (4.5 m) from powered ventilation air intake devices.

**27.8.1.4** Manifolding of vent piping shall be prohibited except where required for special purposes such as vapor recovery, vapor conservation, or air pollution control.

**27.8.1.4.1** Where vent piping is manifolded, pipe sizes shall be capable of discharging, within the pressure limitations of the system, the vapors they are required to handle when all manifolded tanks are subject to the same fire exposure.

**27.8.1.5** Vent piping for tanks storing Class I liquids shall not be manifolded with vent piping for tanks storing Class II or Class III liquids unless positive means are provided to prevent the following:

- (1) Vapors of Class I liquids from entering tanks storing Class II or Class III liquids
- (2) Contamination
- (3) Possible change in classification of the less volatile liquid

**27.8.1.6\* Extension of Emergency Vent Piping.** Piping to or from approved emergency vent devices for atmospheric and low-pressure tanks shall be sized to provide emergency vent flows that limit the back pressure to less than the maximum pressure permitted by the design of the tank. Piping to or from approved emergency vent devices for pressure vessels shall be sized in accordance with the ASME *Boiler and Pressure Vessel Code*.

### 27.8.2 Vent Piping for Underground Tanks.

**27.8.2.1\*** Vent pipes from underground tanks storing Class I liquids shall be located so that the discharge point is outside of buildings, higher than the fill pipe opening, and not less than 12 ft (3.6 m) above the adjacent ground level.

**27.8.2.2** Vent pipe outlets shall be located and directed so that vapors will not accumulate or travel to an unsafe location, enter building openings, or be trapped under eaves and shall be at least 5 ft (1.5 m) from building openings and at least 15 ft (4.5 m) from powered ventilation air intake devices.

**27.8.2.3** Vent pipes shall not be obstructed by devices provided for vapor recovery or other purposes unless the tank and associated piping and equipment are otherwise protected to limit back-pressure development to less than the maximum working pressure of the tank and equipment by the provision of pressure-vacuum vents, rupture discs, or other tank-venting devices installed in the tank vent lines.

**27.8.2.4** Vent outlets and devices shall be protected to minimize the possibility of blockage from weather, dirt, or insect nests.

**27.8.2.5** Vent piping shall be sized in accordance with Table 23.6.2.

**27.8.2.6** Vent pipes from tanks storing Class II or Class IIIA liquids shall terminate outside of the building and higher than the fill pipe opening.

**27.8.2.7** Vent outlets shall be above normal snow level.

**27.8.2.8** Vent pipes shall be permitted to be fitted with return bends, coarse screens, or other devices to minimize ingress of foreign material.

**27.8.2.9** Vent pipes and vapor return piping shall be installed without sags or traps in which liquid can collect.

**27.8.2.10** Condensate tanks, if utilized, shall be installed and maintained so that blocking of the vapor return piping by liquid is prevented.

**27.8.2.11** Vent pipes and condensate tanks shall be located so that they will not be subjected to physical damage. The tank end of the vent pipe shall enter the tank through the top.

**27.8.2.12** Where tank vent piping is manifolded, pipe sizes shall be such as to discharge, within the pressure limitations of the system, the vapors they could be required to handle when manifolded tanks are filled simultaneously.

**27.8.2.12.1** Float-type check valves installed in tank openings connected to manifolded vent piping to prevent product contamination shall be permitted to be used, provided that the tank pressure will not exceed that permitted by 23.5.3.2 when the valves close.

**27.8.2.13** Vent piping for tanks storing Class I liquids shall not be manifolded with vent piping for tanks storing Class II or Class III liquids unless positive means are provided to prevent the following:

- (1) Vapors of Class I liquids from entering tanks storing Class II or Class III liquids
- (2) Contamination
- (3) Possible change in classification of the less volatile liquid

**27.9 Bonding and Grounding.** Piping systems shall be bonded and grounded in accordance with 6.5.4.

**27.10\* Identification and Marking of Piping Systems.** Each loading and unloading riser shall be marked to identify the product for which it is to be used.

### 27.11 Special Requirements for Marine Piping Systems.

**27.11.1** Where piping is from a floating structure or pier, an approved flexible connector shall be permitted between the fixed shore piping and the piping on the floating structure or pier and between separate sections of the floating structure to accommodate changes in water level.

**27.11.2** The interior of the flexible connectors shall be compatible with the liquid handled.

**27.11.3** The exterior of the flexible connectors shall be resistant to or shielded from salt water and fresh water, ultraviolet radiation, physical damage, and damage by fire.

**27.11.4** The flexible connectors shall be suitable for the intended pressures and shall be tested in accordance with Section 27.7.

**27.12 Removal from Service of Piping Systems.** Piping systems taken out of service or abandoned shall be temporarily or permanently closed in accordance with this section.

**27.12.1 Temporary Closure. (Reserved)**

**27.12.2 Permanent Closure in Place. (Reserved)**

**27.12.3 Permanent Removal. (Reserved)**

## Chapter 28 Bulk Loading and Unloading Facilities for Tank Cars and Tank Vehicles

**28.1 Scope.** This chapter shall apply to operations involving the loading or unloading of tank cars and tank vehicles.

**28.2 Definitions Specific to Chapter 28. (Reserved)**

**28.3 General Requirements.**

**28.3.1 Bonding and Grounding and Stray Currents.**

**28.3.1.1** Bonding for the control of static electricity shall not be required where the following conditions exist:

- (1) Where tank cars and tank vehicles are loaded exclusively with products that do not have static-accumulating properties, such as asphalts (including cutback asphalts), most crude oils, residual oils, and water-soluble liquids
- (2) Where no Class I liquids are handled at the loading facility and where the tank cars and tank vehicles loaded are used exclusively for Class II and Class III liquids at temperatures below their flash points
- (3) Where tank cars and tank vehicles are loaded or unloaded through closed connections



**28.3.1.2\*** Loading and unloading facilities that are used to load liquids into tank vehicles through open domes shall be provided with a means for electrically bonding to protect against static electricity hazards.

**28.3.1.2.1** Such means shall consist of a metallic bond wire that is permanently electrically connected to the fill pipe assembly or to some part of the rack structure that is in electrical contact with the fill pipe assembly.

**28.3.1.2.2** The free end of this wire shall be provided with a clamp or an equivalent device for convenient attachment to some metallic part that is in electrical contact with the cargo tank of the tank vehicle.

**28.3.1.2.3** All parts of the fill pipe assembly, including, but not limited to, the drop tube, rack structure and piping, shall form a continuous electrically conductive path that is directed to ground through the rack assembly or by conductive wiring.

**28.3.1.3** Loading and unloading facilities that are used to transfer liquids into and from tank cars through open domes shall be protected against stray currents by permanently bonding the fill pipe to at least one rail and to the facility structure, if of metal.

**28.3.1.3.1** Multiple pipelines that enter the area shall be permanently bonded together.

**28.3.1.3.2** In areas where excessive stray currents are known to exist, all pipelines entering the area shall be provided with insulating sections to electrically isolate them from the facility piping.

*Exception: These precautions need not be required where only Class II or Class III liquids, at temperatures below their flash points, are handled and where there is no probability that tank cars will contain vapors from previous cargoes of Class I liquids.*

**28.3.2 Reserved.**

#### **28.4 Location of Loading and Unloading Facilities.**

**28.4.1** Tank vehicle and tank car loading and unloading facilities shall be separated from aboveground tanks, warehouses, other plant buildings, or the nearest line of adjoining property that can be built upon by a distance of at least 25 ft (7.6 m) for Class I liquids and for Class II and Class III liquids handled at temperatures at or above their flash points and at least 15 ft (4.6 m) for Class II and Class III liquids handled at temperatures below their flash points, measured from the nearest fill spout or transfer connection.

**28.4.2\*** These distances shall be permitted to be reduced if there is suitable protection for exposures.

**28.4.3** Buildings for pumps or shelters for personnel shall be permitted to be a part of the facility.

**28.5 Roofed Structures.** A loading or unloading facility that has a canopy or roof that does not limit the dissipation of heat or dispersion of flammable vapors and does not restrict fire-fighting access and control shall be treated as an outdoor facility.

**28.6 Fire Protection. (Reserved)**

**28.7 Emergency Control Systems. (Reserved)**

**28.8 Electrical Systems.** Electrical wiring and electrical utilization equipment shall comply with Chapter 7.

**28.9\* Containment, Drainage, and Spill Control.** Loading and unloading facilities shall be provided with drainage systems or other means to contain spills.

#### **28.10 Equipment.**

**28.10.1** Equipment such as piping, pumps, and meters used for the transfer of Class I liquids between storage tanks and the fill stem of the loading facility shall not be used for the transfer of Class II or Class III liquids unless one of the following conditions exists:

- (1) Only water-miscible liquid mixtures are handled, and the class of the mixture is determined by the concentration of liquid in water.
- (2) The equipment is cleaned between transfers.

**28.10.2** Remote pumps located in underground tanks shall have a listed leak detection device installed on the pump discharge side that will indicate if the piping system is not essentially liquidtight.

**28.10.2.1** This device shall be checked and tested at least annually according to the manufacturer's specifications to ensure proper installation and operation.

#### **28.11 Operating Requirements.**

##### **28.11.1 Loading and Unloading of Tank Vehicles.**

**28.11.1.1** Liquids shall be loaded only into cargo tanks whose material of construction is compatible with the chemical characteristics of the liquid. The liquid being loaded shall also be chemically compatible with the liquid hauled on the previous load unless the cargo tank has been cleaned.

**28.11.1.2** Before loading tank vehicles through open domes, a bonding connection shall be made to the vehicle or tank before dome covers are raised and shall remain in place until filling is completed and all dome covers have been closed and secured, unless one of the conditions of 28.3.1 exists.

**28.11.1.3** When transferring Class I liquids, or Class II or Class III liquids at temperatures at or above their flash points, engines of tank vehicles or motors of auxiliary or portable pumps shall be shut down during the making and breaking of hose connections.

**28.11.1.4** If loading or unloading is done without requiring the use of the motor of the tank vehicle, the motor shall be shut down throughout any transfer operations involving Class I liquids.

**28.11.1.5\*** Filling through open domes into tank vehicles that contain vapor-air mixtures within the flammable range or where the liquid being filled can form such a mixture shall be by means of a downspout that extends to within 6 in. (150 mm) of the bottom of the tank unless the liquid is not an accumulator of static electric charges.

**28.11.1.6** When top loading a tank vehicle with Class I or Class II liquids without a vapor control system, valves used for the final control of flow shall be of the self-closing type and shall be manually held open except where automatic means are provided for shutting off the flow when the vehicle is full.

**28.11.1.6.1** Automatic shutoff systems shall be provided with a manual shutoff valve located at a safe distance from the loading nozzle to stop the flow if the automatic system fails.

**28.11.1.6.2** When top loading a tank vehicle with vapor control, flow control shall be in accordance with 28.11.1.8 and 28.11.1.9.

**28.11.1.7** When bottom loading a tank vehicle, a positive means shall be provided for loading a predetermined quantity of liquid, together with a secondary automatic shutoff control to prevent overflow.

**28.11.1.7.1** The connecting components between the loading rack and the tank vehicle that are required to operate the secondary control shall be functionally compatible.

**28.11.1.7.2** The connection between the liquid loading hose or pipe and the tank vehicle piping shall be by means of a dry disconnect coupling.

**28.11.1.8** When bottom loading a tank vehicle that is equipped for vapor control, but when vapor control is not used, the tank shall be vented to the atmosphere, at a height not lower than the top of the cargo tank of the vehicle, to prevent pressurization of the tank.

**28.11.1.8.1** Connections to the facility's vapor control system shall be designed to prevent the escape of vapor to the atmosphere when the system is not connected to a tank vehicle.

**28.11.1.9** When bottom loading is used, reduced flow rates (until the fill opening is submerged), splash deflectors, or other devices shall be used to prevent splashing and to minimize turbulence.

**28.11.1.10** Metal or conductive objects, such as gauge tapes, sample containers, and thermometers, shall not be lowered into or suspended in a compartment while the compartment is being filled or immediately after cessation of pumping, in order to permit the relaxation of charge.

**28.11.1.11** Hose materials used for transfer shall be compatible with the liquids being handled.

## **28.11.2 Loading and Unloading of Tank Cars.**

**28.11.2.1** Liquids shall be loaded only into tank cars whose material of construction is compatible with the chemical characteristics of the liquid. The liquid being loaded shall also be chemically compatible with the liquid hauled on the previous load unless the tank car has been cleaned.

**28.11.2.2\*** Filling through open domes into tank cars that contain vapor-air mixtures within the flammable range, or where the liquid being filled can form such a mixture, shall be by means of a downspout that extends to within 6 in. (150 mm) of the bottom of the tank unless the liquid is not an accumulator of static electric charges.

**28.11.2.3** When bottom loading is used, reduced flow rates (until the fill opening is submerged), splash deflectors, or other devices shall be used to prevent splashing and to minimize turbulence.

**28.11.2.4** Metal or conductive objects, such as gauge tapes, sample containers, and thermometers, shall not be lowered into or suspended in a compartment while the compartment is being filled or immediately after cessation of pumping, in order to permit the relaxation of charge.

**28.11.2.5** Hose materials used for transfer shall be compatible with the liquids being handled.

**28.11.3\* Switch Loading.** To prevent hazards due to a change in flash point of liquids, any tank car or tank vehicle that has previously contained a Class I liquid shall not be loaded with a Class II or Class III liquid unless proper precautions are taken.

**28.11.4** The person responsible for loading or unloading shall remain in attendance during the operation or be able to locally or remotely monitor and control the operation for the duration of the operation.

*Exception: A responsible person shall not be required where a hazards analysis shows that the loading or unloading operation can be safely shut down in an emergency.*

**28.11.4.1\*** The responsible person shall be trained to recognize unsafe conditions and take appropriate actions.

## **Chapter 29 Wharves**

### **29.1 Scope.**

**29.1.1** This chapter shall apply to all wharves, as defined in 3.3.63, whose primary purpose is the bulk transfer of liquids.

**29.1.2** This chapter shall not apply to the following:

- (1) Marine service stations, as covered in NFPA 30A, *Code for Motor Fuel Dispensing Facilities and Repair Garages*
- (2) Marinas and boatyards, as covered in NFPA 303, *Fire Protection Standard for Marinas and Boatyards*
- (3) Wharves that handle liquefied petroleum gas, as covered in NFPA 58, *Liquefied Petroleum Gas Code*, or liquefied natural gas, as covered in NFPA 59A, *Standard for the Production, Storage, and Handling of Liquefied Natural Gas (LNG)*

### **29.2 Definitions Specific to Chapter 29. (Reserved)**

### **29.3 General Requirements.**

**29.3.1** General-purpose wharves that handle bulk transfer of liquids and other commodities shall meet the requirements of NFPA 307, *Standard for the Construction and Fire Protection of Marine Terminals, Piers, and Wharves*.

**29.3.2** Incidental handling of packaged cargo of liquids and loading or unloading of general cargo, such as ships' stores, during transfer of liquids shall be conducted only when approved by the wharf supervisor and the senior officer of the vessel.

**29.3.3** Wharves at which liquid cargoes are to be transferred in bulk to or from tank vessels shall be at least 100 ft (30 m) from any bridge over a navigable waterway or from any entrance to or superstructure of a vehicular or railroad tunnel under a waterway.

**29.3.4** The termination of the loading or unloading fixed piping shall be at least 200 ft (60 m) from any bridge or from any entrance to or superstructure of a tunnel.

**29.3.5** The substructure and deck of the wharf shall be designed for the use intended.

**29.3.6** The deck of the wharf shall be permitted to be of any material that will afford the desired combination of flexibility, resistance to shock, durability, strength, and fire resistance.

**29.3.7** Heavy timber construction shall be permitted.

**29.3.8** Tanks used exclusively for ballast water or Class II or Class III liquids stored at temperatures below their flash points shall be permitted to be installed on a wharf designed to support the weight of the tanks and their contents.

**29.3.9** Loading pumps capable of building up pressures that exceed the safe working pressure of cargo hose or loading



arms shall be provided with bypasses, relief valves, or other arrangements to protect the loading facilities against excessive pressure.

**29.3.9.1** Relief devices shall be tested at least annually to determine that they function satisfactorily at their set pressure.

**29.3.10** All pressure hose and couplings shall be inspected at intervals recommended by the manufacturer for the service in which they are used.

**29.3.10.1** With the hose extended, the hose and couplings shall be tested using the in-service maximum operating pressure.

**29.3.10.2** Any hose showing material deterioration, signs of leakage, or weakness in its carcass or at the couplings shall be withdrawn from service and repaired or discarded.

**29.3.10.3** The hose materials used for transfer shall be compatible with the liquids being handled.

**29.3.11** Piping, valves, and fittings shall meet applicable requirements of Chapter 27 and shall also meet the following requirements:

- (1) Flexibility of piping shall be assured by layout and arrangement of piping supports so that motion of the wharf structure resulting from wave action, currents, tides, or the mooring of vessels will not subject the piping to excessive strain.
- (2) Pipe joints that depend on the friction characteristics of combustible materials or on the grooving of pipe ends for mechanical continuity of piping shall not be permitted.
- (3) Swivel joints shall be permitted to be used in piping to which hose are connected and for articulated swivel-joint transfer systems, provided the design is such that the mechanical strength of the joint will not be impaired if the packing materials should fail, for example, by exposure to fire.
- (4) Each line conveying Class I or Class II liquids leading to a wharf shall be provided with a readily accessible block valve located on shore near the approach to the wharf and outside of any diked area. Where more than one line is involved, the valves shall be identified as to their specific lines and grouped in one location.
- (5) Means shall be provided for easy access to any cargo line valves that are located below the wharf deck.

**29.3.12** Pipelines on wharves that handle Class I or Class II liquids or Class III liquids at temperatures at or above their flash points, shall be bonded and grounded.

**29.3.12.1** Insulating flanges or joints shall be installed for protection against stray currents.

**29.3.12.2** Bonding and grounding connections on all pipelines shall be located on the wharf side of insulating flanges, if used, and shall be accessible for inspection.

**29.3.12.3** Bonding between the wharf and the vessel shall not be required.

**29.3.13** Hose or articulated swivel-joint pipe connections used for cargo transfer shall be capable of accommodating the combined effects of change in draft and change in tide. Hose shall be supported to avoid kinking and damage from chafing.

**29.3.14** Mooring lines shall be kept adjusted to prevent surge of the vessel from placing stress on the cargo transfer system.

**29.3.15** Material shall not be placed on wharves in such a manner as to obstruct access to fire-fighting equipment or important pipeline control valves.

**29.3.16** Where the wharf is accessible to vehicle traffic, an unobstructed roadway to the shore end of the wharf shall be maintained for access of fire-fighting apparatus.

**29.3.17** Loading or unloading shall not commence until the wharf supervisor and the person in charge of the tank vessel agree that the tank vessel is properly moored and all connections are properly made.

**29.3.18** Mechanical work shall not be performed on the wharf during cargo transfer, except under special authorization based on a review of the area involved, methods to be employed, and precautions necessary.

**29.3.19** Sources of ignition shall be controlled during transfer of liquids.

**29.3.20** Vehicular traffic and mechanical work including, but not limited to, welding, grinding, and other hot work, shall not be performed during cargo transfer except as authorized by the wharf supervisor and the senior officer on the vessel.

**29.3.21** Smoking shall be prohibited at all times on the wharf during cargo transfer operations.

**29.3.22** For marine terminals handling flammable liquids and combustible liquids at temperatures at or above their flash points, Figure 29.3.22 shall be used to determine the extent of classified areas for the purpose of installation of electrical equipment.

**29.3.23** Where a flammable atmosphere can exist in the vessel cargo compartment, cargo transfer systems shall be designed to limit the velocity of the incoming liquid stream to 3 ft (0.9 m) per second until the compartment inlet opening is sufficiently submerged to prevent splashing.

**29.3.24** Filters, pumps, wire screens, and other devices that can produce static electric charges through turbulence shall be so located to allow a minimum of 30 seconds of relaxation time prior to discharging cargo into the compartment.

**29.3.25\*** Spill collection shall be provided around manifold areas to prevent spread of liquids to other areas of the wharf or under the wharf.

**29.3.26** Vapor seals shall be provided on all drain lines leaving the wharf.

**29.3.27** Where required, wharves shall have a system to isolate and shut down the loading operation in the event of failure of a hose, loading arm, or manifold valve. This system shall meet all of the following requirements:

- (1) If the protective system closes a valve on a gravity-fed or pipeline-fed loading system, it shall be designed to ensure the line is not subjected to damage from pressure surges.
- (2) Emergency shutdown systems shall be permitted to be automatically or manually activated.

**29.3.27.1** Manually activated device(s) shall be identified and accessible during an emergency.

**29.3.28\*** Fire protection and emergency response equipment for wharves shall be related to the products being handled, emergency response capability, size, location, frequency of use, and adjacent exposures.

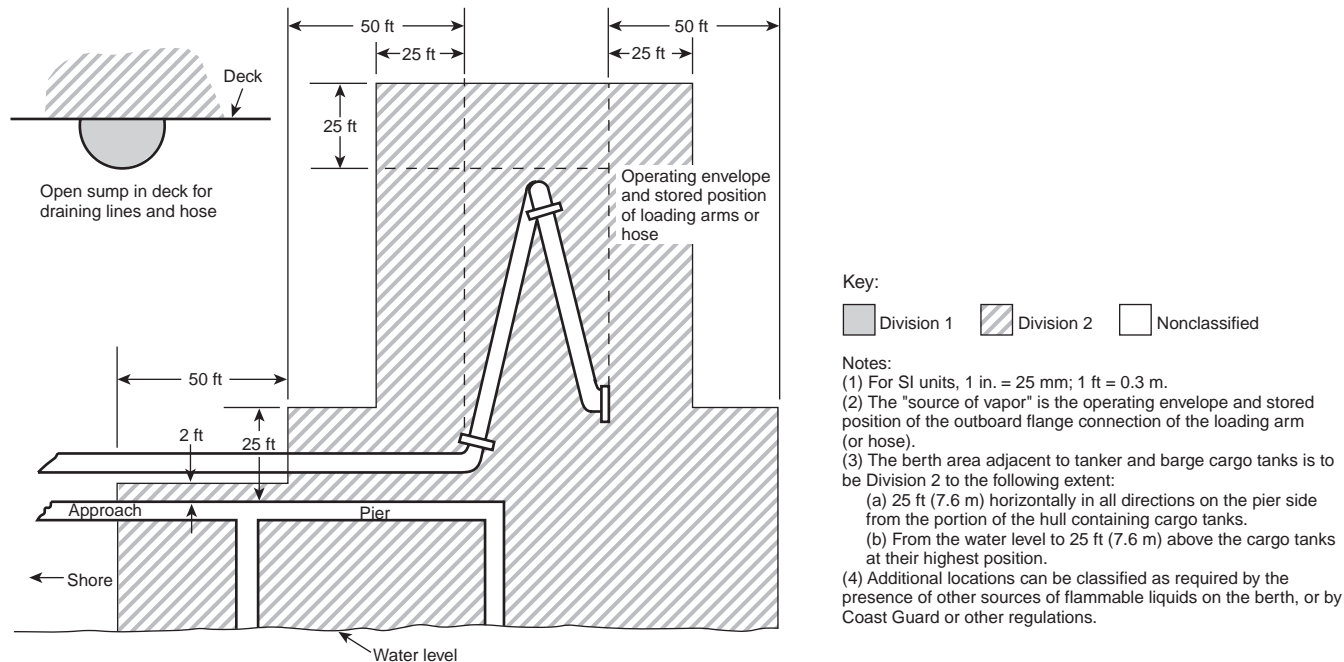

FIGURE 29.3.22 Area Classification for a Marine Terminal Handling Flammable Liquids.

**29.3.28.1** Where a fire water main is provided, the main shall be permitted to be wet or dry. In all cases, isolation valves and fire department connections shall be provided at the wharf-to-shore connection.

**29.3.28.2** Where a fire water main is provided, hydrants and monitors shall also be provided so that effective fire water streams can be applied to any berth or loading manifold from two directions.

**29.3.28.3** Fire water pumps, fire hose, fire water mains, foam systems, and other fire suppression equipment shall be maintained and tested in accordance with NFPA 25, *Standard for the Inspection, Testing, and Maintenance of Water-Based Fire Protection Systems*.

**29.3.28.4** Where no fire water main is provided, at least two 150 lb (68 kg) dry chemical extinguishers shall be provided. The extinguishers shall be located within 50 ft (15 m) of pump or manifold areas and shall be easily reached along emergency access paths.

## Annex A Explanatory Material

*Annex A is not a part of the requirements of this NFPA document but is included for informational purposes only. This annex contains explanatory material, numbered to correspond with the applicable text paragraphs.*

**A.1.1.1** This code is recommended for use as the basis for legal regulations. Its provisions are intended to reduce the hazard to a degree consistent with reasonable public safety, without undue interference with public convenience and necessity, of operations that require the use of flammable and combustible liquids. Compliance with this code does not eliminate all hazards in the use of flammable and combustible

liquids. (*See the Flammable and Combustible Liquids Code Handbook for additional explanatory information.*)

**A.1.1.2(1)** Liquids that are solid at 100°F (37.8°C) or above, but are handled, used, or stored at temperatures above their flash points, should be reviewed against pertinent sections of this code.

**A.1.1.2(2)** The information in A.1.1.2(1) also applies here.

**A.1.1.2(4)** Certain mixtures of flammable or combustible liquids and halogenated hydrocarbons either do not exhibit a flash point using the standard closed-cup test methods or will exhibit elevated flash points. However, if the halogenated hydrocarbon is the more volatile component, preferential evaporation of this component can result in a liquid that does have a flash point or has a flash point that is lower than the original mixture. In order to evaluate the fire hazard of such mixtures, flash point tests should be conducted after fractional evaporation of 10, 20, 40, 60, or even 90 percent of the original sample or other fractions representative of the conditions of use. For systems such as open process tanks or spills in open air, an open-cup test method might be more appropriate for estimating the fire hazard.

**A.1.1.2(5)** See NFPA 30B, *Code for the Manufacture and Storage of Aerosol Products*.

**A.1.1.2(7)** Requirements for transportation of flammable and combustible liquids can be found in NFPA 385, *Standard for Tank Vehicles for Flammable and Combustible Liquids*, and in the U.S. Department of Transportation's Hazardous Materials Regulations, Title 49, Code of Federal Regulations, Parts 100-199.

**A.1.1.2(8)** See NFPA 31, *Standard for the Installation of Oil-Burning Equipment*.



**A.1.1.2(9)** Requirements for the use and installation of alcohol-based hand rubs are covered in NFPA 1, *Fire Code*, and NFPA 101, *Life Safety Code*.

**A.1.2** Requirements for the safe storage and use of many flammable and combustible liquids commonly available depend primarily on their fire characteristics, particularly the flash point, which is the basis for the classification system described in Chapter 4. It should be noted that a liquid's classification can be changed by contamination. For example, placing a Class II liquid into a tank that last contained a Class I liquid can change the flash point of the former so that it falls into the range of a Class I liquid. The same situation can exist where a Class II liquid is exposed to the vapors of a Class I liquid via an interconnecting vapor line. (See 27.8.1.5 and 27.8.2.13.) Care should be exercised in such cases to apply the requirements appropriate to the actual classification. Refer to *Fire Protection Guide to Hazardous Materials* for flash point and other fire hazard data.

The volatility of a liquid is increased by heating. Where Class II or Class III liquids are exposed to storage conditions, use conditions, or process operations where they are naturally or artificially heated up to or above their flash points, additional fire safety features, such as ventilation, separation from ignition sources, diking, or electrical area classification, might be necessary.

Additional fire safety considerations might also be necessary for the safe storage and use of liquids that have unusual burning characteristics, that are subject to self-ignition when exposed to air, that are highly reactive with other substances, that are subject to explosive decomposition, or that have other special properties that dictate safeguards over and above those specified for a normal liquid of similar flash point classification.

**A.1.4.2** An existing situation involving a distinct hazard to life or adjacent property includes conditions that might result in an explosion or sudden escalation of a fire. Examples include, but are not limited to, inadequate ventilation of confined spaces, lack of adequate emergency venting of a tank, failure to fireproof the supports of elevated tanks, or lack of drainage or dikes to control spills.

**A.3.2.1 Approved.** The National Fire Protection Association does not approve, inspect, or certify any installations, procedures, equipment, or materials; nor does it approve or evaluate testing laboratories. In determining the acceptability of installations, procedures, equipment, or materials, the authority having jurisdiction may base acceptance on compliance with NFPA or other appropriate standards. In the absence of such standards, said authority may require evidence of proper installation, procedure, or use. The authority having jurisdiction may also refer to the listings or labeling practices of an organization that is concerned with product evaluations and is thus in a position to determine compliance with appropriate standards for the current production of listed items.

**A.3.2.2 Authority Having Jurisdiction (AHJ).** The phrase "authority having jurisdiction," or its acronym AHJ, is used in NFPA documents in a broad manner, since jurisdictions and approval agencies vary, as do their responsibilities. Where public safety is primary, the authority having jurisdiction may be a federal, state, local, or other regional department or individual such as a fire chief; fire marshal; chief of a fire prevention bureau, labor department, or health department; building official; electrical inspector; or others having statutory authority. For insurance purposes, an insurance inspection de-

partment, rating bureau, or other insurance company representative may be the authority having jurisdiction. In many circumstances, the property owner or his or her designated agent assumes the role of the authority having jurisdiction; at government installations, the commanding officer or departmental official may be the authority having jurisdiction.

**A.3.2.3 Code.** The decision to designate a standard as a "code" is based on such factors as the size and scope of the document, its intended use and form of adoption, and whether it contains substantial enforcement and administrative provisions.

**A.3.2.5 Listed.** The means for identifying listed equipment may vary for each organization concerned with product evaluation; some organizations do not recognize equipment as listed unless it is also labeled. The authority having jurisdiction should utilize the system employed by the listing organization to identify a listed product.

**A.3.3.6 Boil-Over.** Boil-over occurs when the residues from surface burning become more dense than the unburned oil and sink below the surface to form a hot layer, which progresses downward much faster than the regression of the liquid surface. When this hot layer, called a "heat wave," reaches water or water-in-oil emulsion in the bottom of the tank, the water is first superheated and then boils almost explosively, overflowing the tank. Oils subject to boil-over consist of components having a wide range of boiling points, including both light ends and viscous residues. These characteristics are present in most crude oils and can be produced in synthetic mixtures.

A boil-over is an entirely different phenomenon from a slop-over or froth-over. Slop-over involves a minor frothing that occurs when water is sprayed onto the hot surface of a burning oil. Froth-over is not associated with a fire but results when water is present or enters a tank containing hot viscous oil. Upon mixing, the sudden conversion of water to steam causes a portion of the tank contents to overflow.

**A.3.3.8.1 Important Building.** Examples of important buildings include occupied buildings where egress within 2 minutes cannot be reasonably expected, and control buildings that require presence of personnel for orderly shutdown of important or hazardous processes. Important buildings can also include unprotected storage where products from fire can harm the community or the environment or buildings that contain high-value contents or critical equipment or supplies.

**A.3.3.12 Container.** The U.S. DOT defines *non-bulk packaging* as having up to 119 gal (450 L) capacity in 49 CFR 171.8.

**A.3.3.12.3 Nonmetallic Container.** Permissible nonmetallic containers for shipping Class I, Class II, and Class IIIA liquids are governed by the hazardous materials transportation regulations promulgated by the United Nations publication, *Recommendations on the Transport of Dangerous Goods*, and the U.S. Department of Transportation's Hazardous Materials Regulations, Title 49, Code of Federal Regulations. Small tanks for Class IIIB liquids are not governed by these regulations. Fiber portable tanks for Class IIIB liquids include composite designs consisting of a multi-ply cardboard box with a rigid or flexible plastic bladder.

**A.3.3.12.4 Nonmetallic Intermediate Bulk Container.** Permissible nonmetallic intermediate bulk containers for shipping Class I, Class II, and Class IIIA liquids are governed by the



hazardous materials transportation regulations promulgated by the United Nations publication, *Recommendations on the Transport of Dangerous Goods*, and the U.S. Department of Transportation's Hazardous Materials Regulations, Title 49, Code of Federal Regulations. Intermediate bulk containers for Class IIIB liquids are not governed by these regulations. Fiber intermediate bulk containers for Class IIIB liquids include composite designs consisting of a cardboard box with a flexible plastic bladder, which is commonly referred to as a "bag-in-box" container.

**A.3.3.22 Fugitive Emissions.** These include leaks from pump seals, valve packing, flange gaskets, compressor seals, process drains, and so forth.

**A.3.3.24 Hazardous Material or Hazardous Chemical.** These dangers can arise from, but are not limited to, toxicity, reactivity, instability, or corrosivity.

**A.3.3.26 Hazardous Reaction or Hazardous Chemical Reaction.** These dangers might include, but are not limited to, toxic effects, reaction speed (including detonation), exothermic reaction, or production of unstable or reactive materials.

**A.3.3.32.2 Flammable Liquid.** For the purposes of this code, a material with a Reid vapor pressure greater than an absolute pressure of 40 psi (276 kPa) is considered to be a gas and is, therefore, not within the scope of NFPA 30. See NFPA 58, *Liquefied Petroleum Gas Code*.

**A.3.3.33.4 Unstable Liquid.** Refer to NFPA 704, *Standard System for the Identification of the Hazards of Materials for Emergency Response*, for additional information regarding the classification of unstable liquids.

**A.3.3.33.5 Water-Miscible Liquid.** Liquids that are water-miscible include low molecular weight (3 carbons or less) alcohols, such as methyl alcohol, ethyl alcohol, n-propyl alcohol, isopropyl alcohol, and allyl alcohol. Acetone and tert-butyl alcohol are also water-miscible.

When water-miscible flammable liquids are mixed with water, a homogeneous solution is formed. The flash point, fire point, heat of combustion, and heat release rate for the solution will be different from the pure liquid. The flash point and fire point of the solution will increase as the water concentration increases. At a certain water concentration, which varies for different liquids, the fire point will no longer exist and the solution will no longer present a fire hazard.

**A.3.3.38 Maximum Allowable Quantity (MAQ).** Quantities of flammable and combustible liquids are permitted to exceed the MAQs when they are located in an area that complies with Protection Levels 2 and 3 in accordance with this code and with the building code.

**A.3.3.41 Operating Unit (Vessel) or Process Unit (Vessel).** Unit operations include, but are not limited to, distillation, oxidation, cracking, and polymerization.

**A.3.3.43 Pier.** The terms *pier* and *wharf* are used interchangeably. [307, 2011]

**A.3.3.45 Process or Processing.** The sequence can include both physical and chemical operations, unless the term is modified to restrict it to one or the other. The sequence can involve, but is not limited to, preparation, separation, purification, or change in state, energy content, or composition.

**A.3.3.48 Safety Can.** Safety cans listed to ANSI/UL 30, *Standard for Metal Safety Cans*, are limited to 5 U.S. gal (19 L). ANSI/UL

1313, *Standard for Nonmetallic Safety Cans for Petroleum Products*, allows for capacities up to 5 Imperial gal (23 L).

**A.3.3.51.2 Atmospheric Tank.** Older-style flat roof tanks were designed to operate at pressures from atmospheric through a gauge pressure of 0.5 psi (3.5 kPa), measured at the top of the tank. This limitation was established to avoid continuous stress on the roof plates of the tank.

**A.3.3.51.4.1 Nonmetallic Portable Tank.** Permissible nonmetallic portable tanks for shipping Class I, Class II, and Class IIIA liquids are governed by hazardous materials transportation regulations promulgated by the United Nations (UN) and the U.S. Department of Transportation (DOT). Small tanks for Class IIIB liquids are not governed by either UN or DOT hazardous materials regulations. Fiber portable tanks for Class IIIB liquids include composite designs consisting of a multi-ply corrugated box with a rigid or flexible inner plastic bladder.

**A.3.3.56 Vapor Processing System.** Examples are systems using blower-assist for capturing vapors and refrigeration, absorption, and combustion systems for processing vapors.

**A.3.3.57 Vapor Recovery System.** Examples are balanced-pressure vapor displacement systems and vacuum-assist systems without vapor processing.

**A.3.3.61 Ventilation.** Ventilation can be achieved by introduction of fresh air to dilute contaminated air or by local exhaust of contaminated air. Ventilation is considered adequate if it is sufficient to prevent accumulation of significant quantities of vapor-air mixtures in concentrations over one-fourth of the lower flammable limit (LFL).

**A.3.3.62 Warehouse.** Warehousing operations referred to in these definitions are those operations not accessible to the public and include general-purpose, merchandise, distribution, and industrial warehouse-type operations.

**A.3.3.63 Wharf.** The terms *wharf* and *pier* are used interchangeably. [307, 2011]

**A.4.2.1** At the boiling point, the surrounding atmospheric pressure can no longer hold the liquid in the liquid state and the liquid boils. A low boiling point is indicative of a high vapor pressure and a high rate of evaporation.

**A.4.2.4** Flash point is a direct measure of a liquid's ability to emit flammable vapors. The lower the flash point, the greater the risk of fire. Flash point is determined using one of several different test procedures and apparatus that are specified in Section 4.4.

A liquid that has a flash point at or below ambient temperature is easy to ignite and will burn quickly. On ignition, the spread of flame over the surface of such a liquid will be rapid, because it is not necessary for the fire to expend energy heating the liquid to generate more vapor. Gasoline is a familiar example. A liquid with a flash point above ambient temperature presents less risk because it must be heated to generate enough vapor to become ignitable; it is more difficult to ignite and presents less potential for the generation and spread of vapor. A common example is home heating oil (Fuel Oil No. 2). Home heating oil must be atomized to a fine mist in order for it to be easily ignited.

Certain solutions of liquids in water exhibit a flash point using the standard closed-cup test procedures but will not burn and could even extinguish a fire. To assist identifying such solutions, the following standards are helpful:



- (1) ASTM D 4207, *Standard Test Method for Sustained Burning of Low Viscosity Liquid Mixtures by the Wick Test*
- (2) ASTM D 4206, *Standard Test Method for Sustained Burning of Liquid Mixtures Using the Small Scale Open-Cup Apparatus*

Liquid mixtures that do not sustain combustion for a specified time at a specified temperature are considered to be non-combustible. The tests described in the references listed in A.4.2.4(1) and A.4.2.4(2) provide additional data for determining proper storage and handling of such mixtures. In a confined space, such mixtures could still create an ignitable vapor–air mixture, depending on the amount of flammable liquid in the mixture and the quantity of the spill.

Related to the flash point is the fire point. The fire point of a liquid is the temperature at which ignition of vapors will result in continued burning. As the term *flash point* suggests, the vapors generated at that temperature will flash but will not necessarily continue to burn. The difference between flash point and fire point has some significance when conducting flash point tests [see 9.1.4(5) and 9.1.4(6)]. However, a closed-cup flash point is used to classify the liquid and characterize its hazard.

For more information, see ASTM E 502, *Standard Test Method for Selection and Use of ASTM Standards for the Determination of Flash Point of Chemicals by Closed Cup Methods*, and the *ASTM Manual on Flash Point Standards and Their Use*.

**A.4.2.6** Vapor pressure is a measure of the pressure that the liquid exerts against the atmosphere above it. Just as the atmosphere exerts pressure on the surface of the liquid, the liquid pushes back. Vapor pressure is normally less than atmospheric pressure and is a measure of the liquid's tendency to evaporate (i.e., to move from the liquid state to the gaseous state). This tendency is also referred to as volatility, thus the use of the term *volatile* to describe liquids that evaporate very easily. The higher the vapor pressure, the greater the rate of evaporation and the lower the boiling point. Simply put, this means more vapors and increased fire risk.

**A.4.3** The classification of liquids is based on flash points that have been corrected to sea level, in accordance with the relevant ASTM test procedures. At high altitudes, the actual flash points will be significantly lower than those either observed at sea level or corrected to atmospheric pressure at sea level. Allowances could be necessary for this difference in order to appropriately assess the risk.

Table A.4.3 presents a comparison of the definitions and classification of flammable and combustible liquids, as set forth in Chapter 4 of this code, with similar definitions and classification systems used by other regulatory bodies.

The Hazardous Materials Regulations of the U.S. Department of Transportation (DOT), as set forth in the Title 49, Code of Federal Regulations, Parts 173.120(b)(2) and 173.150(f), provide an exception whereby a flammable liquid that has a flash point between 37.8°C (100°F) and 60.5°C (141°F) and does not also meet the definition of any other DOT hazard class can be reclassified as a combustible liquid [i.e., one having a flash point above 60.5°C (141°F)] for shipment by road or rail within the United States.

**A.6.1** These provisions might not provide adequate protection for all operations involving hazardous materials or chemical reactions, nor do they consider health hazards resulting from exposure to such materials.

**A.6.3** The evaluation for management of fire hazards should consider probability of an ignitable mixture, the presence of a

credible ignition source, and consequences of an ignition. Where the risk is unacceptable to the authority having jurisdiction, explosion protection in accordance with NFPA 69, *Standard on Explosion Prevention Systems*, or deflagration venting in accordance with NFPA 68, *Standard on Explosion Protection by Deflagration Venting*, or a combination of the two should be provided. See also *Guidelines for Chemical Process Quantitative Risk Analysis*, 2nd edition, from the Center for Chemical Process Safety/American Institute of Chemical Engineers.

**A.6.4.1.1** The wide range in size, design, and location of liquid-processing facilities precludes the inclusion of detailed fire and hazard prevention and control systems and methods applicable to all such facilities. The user should seek further guidance from documents such as NFPA 551, *Guide for the Evaluation of Fire Risk Assessments*.

**A.6.4.1.2** Storage, processing, handling, and use of Class II and Class III liquids at temperatures above the flash point can produce ignitable vapors if the liquid is released or vessels are vented. Class I liquid requirements address such events to minimize the likelihood of ignition and the consequences if ignition occurs, thus becoming a benchmark for design features when Class II and III liquids are handled above the flash point. However, their characteristics differ from those of Class I liquids. For example, the extent of travel of the Class II and III vapors is limited by the quick condensation of released vapors as they cool to lower temperatures. This might justify a more limited electrical area classification, different ventilation, elimination of explosion venting, and so forth. In addition, the process handling these Class II and III heated liquids may incorporate safety design features that accomplish the intent of NFPA 30, that is to address the hazards of released vapors. Further, the more restrictive building construction requirements in Table 17.6.1 might not be necessary for a particular process involving Class II, and III liquids heated above the flash point. The option of conducting an engineering evaluation in accordance with Chapter 6 was included to allow the use of alternative designs to address the level of hazards identified.

**A.6.5.1(8)** With respect to frictional heat or sparks, it is recognized that there is a need to control sources of ignition, including mechanical sparks from hand tools, that have sufficient energy to ignite flammable vapors. Studies, anecdotes, codes, referenced standards, and other historical documents (e.g., API 2214, *Spark Ignition Properties of Hand Tools*) show that there is a potential for hand tool sparks to ignite flammable vapors from a limited number of chemicals and under certain unique conditions. These include flammable liquids with low minimum ignition energies, operations in which flammable or combustible liquids are heated, and atypical spark generation that can occur between specific types of hand tools and struck surfaces (i.e., thermite reactions or impact of steel tools on quartzitic materials). Even spark-resistant tools might not provide suitable protection against ignition. For example, hard metal particles can become imbedded in the relatively soft metal of spark-resistant tools, and these particles can cause sparks when the tools are used.

NFPA 30 requires analyses, such as job safety analyses or activity hazard analyses, of the hazards and risks of a given task and the application of appropriate protective measures to prevent or mitigate the hazards and risks. This includes identification and mitigation of ignition risk from multiple sources, including hand tools. Due to the complexity of the numerous

Table A.4.3 Comparative Classification of Liquids

Agency	Agency Classification	Agency Flash Point		NFPA Definition	NFPA Classification	NFPA Flash Point	
		°F	°C			°F	°C
ANSI Z129.1	Flammable	<141	<60.5	Flammable Combustible	Class I Class II Class IIIA	<100 ≥100 to <140 ≥140 to <200	<37.8 ≥37.8 to <60 ≥60 to <93
	Combustible	≥141 to <200	≥60.5 to <93	Combustible	Class IIIA	≥140 to <200	≥60 to <93
DOT	Flammable	<141	<60.5	Flammable Combustible	Class I Class II Class IIIA	<100 ≥100 to <140 ≥140 to <200	<37.8 ≥37.8 to <60 ≥60 to <93
	Combustible	≥141 to <200	≥60.5 to <93	Combustible	Class IIIA	≥140 to <200	≥60 to <93
DOT HM-181 Domestic Exemption*	Flammable	<100	<37.8	Flammable	Class I	<100	<37.8
	Combustible	≥100 to <200	≥37.8 to <93	Combustible	Class II Class IIIA	≥100 to <140 ≥140 to <200	≥37.8 to <60 ≥60 to <93
UN	Flammable	<141	<60.5	Flammable Combustible	Class I Class II Class IIIA	<100 ≥100 to <140 ≥140 to <200	<37.8 ≥37.8 to <60 ≥60 to <93
	Combustible	≥141 to <200	≥60.5 to <93	Combustible	Class II Class IIIA	≥100 to <140 ≥140 to <200	≥37.8 to <60 ≥60 to <93
OSHA	Flammable	<100	<37.8	Flammable	Class I	<100	<37.8
	Combustible†	≥100	≥37.8	Combustible	Class II Class IIIA Class IIIB†	≥100 to <140 ≥140 to <200 ≥200	≥37.8 to <60 ≥60 to <93 ≥93

\*See A.4.3.

†See 29 CFR 1910.106 for Class IIIB liquid exemptions.

operations involving flammable liquids, NFPA 30 cannot address all conditions in which spark-resistant tools should be made mandatory, might be advisable, or are unnecessary to help control the ignition risk of any given operation.

It is recognized that the adoption of the new Globally Harmonized System for labeling by the U.S. Occupational Safety and Health Administration (29 CFR 1910.1200, Appendix C) creates a generalized mandate for the use of spark-resistant tools. However, based on available technical information, this mandate goes beyond what is considered necessary for fire safety, given the fact that it applies to liquids that present little risk of ignition unless heated to or above their flash points. (See A.6.4.1.2.)

**A.6.5.3** See NFPA 51B, *Standard for Fire Prevention During Welding, Cutting, and Other Hot Work*.

**A.6.5.4** The prevention of electrostatic ignition in equipment is a complex subject. Refer to NFPA 77, *Recommended Practice on Static Electricity*, for guidance.

**A.6.6.1** One method of complying with this requirement could be through the installation of an automatic and/or manual fire alarm system as covered in NFPA 72, *National Fire Alarm and Signaling Code*.

**A.6.7.1** Other recognized fire prevention and control factors, involving construction, location, and separation, are addressed elsewhere in Chapter 6.

**A.6.7.3** Permanent connections to process water lines from the fire water system present an opportunity for contamination of the fire water with process fluids. Incidents have occurred where fire water was contaminated with flammable process liquids, with subsequent increased fire damage and, in some cases, injury. Temporary connections are permitted to meet extraordinary needs, as in turnaround and inspection periods, tank cleaning, and so forth. However, care should be taken to address the potential for contamination. Where such use occurs frequently enough to justify a more robust arrangement, double block-and-bleed valves, removable spool pieces, or other means should be used to assure that no contamination can occur. Check valves alone are not sufficient.

Use of utility water sources, such as boiler feedwater, that are not contaminated, is acceptable for use as a supplemental fire water supply.

**A.6.7.8** NFPA 10, *Standard for Portable Fire Extinguishers*, provides information on the suitability of various types of extinguishers.

**A.7.3.3** For additional information, see NFPA 497, *Recommended Practice for the Classification of Flammable Liquids, Gases, or Vapors and of Hazardous (Classified) Locations for Electrical Installations in Chemical Process Areas*.



**A.7.3.7** NFPA 496, *Standard for Purged and Pressurized Enclosures for Electrical Equipment*, provides details for these types of installations.

**A.9.3.9.3** Section 5.1 of NFPA 505, *Fire Safety Standard for Powered Industrial Trucks Including Type Designations, Areas of Use, Conversions, Maintenance, and Operations*, states, “In locations used for the storage of flammable liquids in sealed containers or liquefied or compressed flammable gases in containers, approved power-operated industrial trucks designated as Types CNS, DS, ES, GS, LPS, GS/CNS, or GS/LPS shall be permitted to be used where approved by the authority having jurisdiction.” Compared to the above types, industrial trucks that are designated DY and EE have significantly less potential for igniting flammable vapors (such as might result from a spill of Class I liquid) and should be used in inside liquid storage areas where conditions warrant.

**A.9.4.1** It is not the intent of Section 9.4 to regulate containers and packaging systems for Class IIIB liquids, except as required for protected storage in accordance with Chapter 16.

**A.9.4.1(6)** The term *rigid nonmetallic intermediate bulk container* is used to describe intermediate bulk containers that have a plastic vessel that serves as the primary liquid-holding component. This vessel can be enclosed in or encased by an outer structure consisting of a steel cage, a single-wall metal or plastic enclosure, a double wall of foamed or solid plastic, or a paperboard enclosure. These are often called *composite IBCs*, which is the term used by the U.S. Department of Transportation (DOT) to describe them. The term *rigid nonmetallic intermediate bulk container* also denotes an all-plastic single-wall IBC that might or might not have a separate plastic base and for which the containment vessel also serves as the support structure. IBCs that have an outer liquidtight metal structure are considered to be metal IBCs or metal portable tanks by DOT and are defined in 9.4.1(1).

**A.9.5** The requirements in Section 9.5 are based on hazards associated with fixed flammable liquids storage cabinets. They do not address potential hazards associated with mobile storage cabinets (i.e., cabinets with integral wheels) such as the following:

- (1) Increased risk of spills
- (2) Potential for tipover or blockage of egress
- (3) Maintenance of vent and grounding integrity
- (4) Variable condition of exposed floor surfaces under the cabinet

**A.9.5.4** Venting of storage cabinets has not been demonstrated to be necessary for fire protection purposes. Additionally, venting a cabinet could compromise the ability of the cabinet to adequately protect its contents from involvement in a fire, because cabinets are not generally tested with any venting. Therefore, venting of storage cabinets is not recommended.

However, it is recognized that some jurisdictions might require storage cabinets to be vented and that venting can also be desirable for other reasons, such as health and safety. In such cases, the venting system should be installed so as to not affect substantially the desired performance of the cabinet during a fire. Means of accomplishing this can include thermally actuated dampers on the vent openings or sufficiently insulating the vent piping system to prevent the internal temperature of the cabinet from rising above that specified. Any make-up air to the cabinet should also be arranged in a similar manner.

If vented, the cabinet should be vented from the bottom with make-up air supplied to the top. Also, mechanical exhaust ventilation is preferred and should comply with NFPA 91, *Standard for Exhaust Systems for Air Conveying of Vapors, Gases, Mists, and Noncombustible Particulate Solids*. Manifolding the vents of multiple storage cabinets should be avoided.

**A.9.5.4.2** A “safe location” should be selected as the location of a vent discharge to minimize the potential for ignitable vapors to travel to a source of ignition after discharge from the vent. Electrical equipment that does not meet the requirements for hazardous locations can serve as an ignition source. The Technical Committee advises that vent discharge locations should consider such factors as the following:

- (1) Characteristics of the exhausted material (vapor density, toxicity, velocity of discharge, etc.)
- (2) Proximity to potential ignition sources
- (3) Building openings such as doors, windows, air intakes, and so forth
- (4) Dispersion characteristics (distance to discharge within the flammable range, direction of discharge, atmospheric conditions, and the influence of building and neighboring buildings on discharged vapors)
- (5) Likelihood of vapor accumulation following discharge, such as accumulation under building eaves
- (6) Likelihood of sufficient discharge volume to allow an ignitable concentration to reach an ignition source

Historically, NFPA 30 has provided prescriptive guidance, often based on area classification requirements, and results have been acceptable. Closer distances should be accepted only if an analysis by a qualified person justifies closer distances. Similarly, the specified distances might not be acceptable for all installations, thus the guidance provided above.

**A.9.5.5** ANSI Z535.2:2007, *Environmental and Facility Safety Signs*, Section 9.2, was used to determine the letter height, based on a safe viewing distance of 25 ft (7.5 m). Markings can be reflective to improve visibility. See ASTM D4956, *Standard Specification for Retroreflective Sheeting for Traffic Control*, for more information on providing reflective surfaces. If international symbols are used, they should be a minimum of 2.0 in. (50 mm) in size.

**A.9.8.1** The Protection Level classifications are taken from *NFPA 5000, Building Construction and Safety Code*. Protection Levels 1, 4, and 5 do not apply to the storage of flammable and combustible liquids and are, therefore, not extracted here.

**A.9.8.2** See *NFPA 5000, Building Construction and Safety Code*, for additional requirements.

**A.9.13** Spill containment can be accomplished by any of the following:

- (1) Noncombustible, liquidtight raised sills, curbs, or ramps of suitable height at exterior openings
- (2) Noncombustible, liquidtight raised sills, curbs, or ramps of suitable height, or other flow-diverting structures at interior openings
- (3) Sloped floors
- (4) Open-grate trenches or floor drains that are connected to a properly designed drainage system
- (5) Wall scuppers that discharge to a safe location or to a properly designed drainage system
- (6) Other means that are acceptable to the authority having jurisdiction

Where sills, curbs, or ramps are used, the appropriate height will depend on a number of factors, including the maximum expected spill volume, the floor area, and the existence of any drainage systems. Historically, curbs and sills have been 4 in. (100 mm) high.

A variety of curb, sill, and ramp heights can be used to obtain the desired containment volume. As a guide, 1 ft<sup>2</sup> of water at a depth of 1 in. equals 0.6 gal (1 m<sup>2</sup> of water @ 25 mm = 25 L). Once the total quantity of liquid containment has been established, the necessary curb, sill, or ramp height can then be calculated.

Where open-grate trenches are used, the volume of the trench should be able to contain the maximum expected spill volume or otherwise be connected to a properly designed drainage system.

It should be noted that these containment and drainage provisions address only fire protection concerns. Consult the appropriate environmental regulations for other restrictions that could apply.

**A.9.16.1** Release of a Class IA liquid into a room or enclosure can result in the evolution of large quantities of flammable vapor. The ignition of this flammable mixture can result in a significant pressure rise, the production of hot combustion gases, and flame. Failure to adequately design a room or building for this type of event can result in the failure of the room or building walls and/or roof and the uncontrolled release of the hot combustion gases, flames, and pressure. An acceptable method of protection against this type of event is the use of damage-limiting construction consisting of a combination of pressure-relieving construction and pressure-resistant construction as described in NFPA 68, *Standard on Explosion Protection by Deflagration Venting*.

**A.9.16.2** Unstable liquids can create deflagration or detonation hazards. A complete engineering review of the type of explosion event that might be produced by an unstable liquid is needed to define the necessary protection measures. Protection measures for detonations require construction features such as barricades.

**A.10.3.6** Use of a liquid storage room or a hazardous material storage locker used as an inside area is not mandated for the storage of liquids in a mercantile occupancy where the quantities in Table 10.7.1 are not exceeded. Where the construction of such spaces is utilized within a mercantile occupancy, guidance is provided in Chapter 9.

**A.12.8.1** The provision of automatic sprinklers designed to protect Class IV commodities to a height of 20 ft (6 m) for the liquid storage quantities and arrangements allowed in a general-purpose warehouse should not be construed as providing adequate protection. Fire tests utilizing such design criteria on the allowed storage arrangements have never been conducted, and other test results imply that control of a liquid pool fire might not be obtained. Examples of fire protection can be found in Chapter 16.

**A.12.8.4** Exception No. 2 is based on work done by FM Global, which showed that flammable liquids in plastic containers could cause uncontrollable fires under certain conditions of storage in general-purpose warehouses. A research project on flammable liquids container storage carried out by Underwriters Laboratories Inc., under the auspices of the National Fire Protection Research Foundation, has suggested a test protocol that can judge the capability of packaging systems to withstand a small ignition source or to minimize the rate at which the lading is released from the containers, so that the fire can be controlled by automatic sprinklers.

**A.13.3.1** The intent of the separation requirements is to assure that unprotected, detached flammable and combustible liquids warehouses are adequately separated from exposed business, industrial, mercantile, and storage occupancies, whether or not they are located on the same property or on an adjacent property on the other side of the property line. Note that if the zoning or other legal restriction applicable to the adjacent property is such that only business, industrial, mercantile, or storage occupancies are permitted to be built on the adjacent property, the separation distances of 13.3.1 are adequate. If the adjacent property is not zoned or otherwise legally restricted to contain only business, industrial, mercantile, or storage occupancies, such that more sensitive occupancies might be exposed by the detached building, then the more restrictive separation distances of 13.3.2 should be used to establish adequate separation.

**A.13.3.2** See A.13.3.1. The intent of the separation distances provided in 13.3.2 is to assure that appropriate separation is provided from an unprotected liquid warehouse and more sensitive occupancies such as assembly, educational, health care, and so forth.

**A.14.1** Environmental concerns have dictated special handling of hazardous materials, chemicals, and wastes. Some of these have flammable and combustible liquid characteristics, in addition to their environmental and health problems, thus causing some questions as to how they should be stored and handled.

Several manufacturers have met this problem by designing and manufacturing movable, modular prefabricated storage lockers, working diligently with various building officials and authorities having jurisdiction. This results in a product that is intended to meet government standards and regulations for hazardous materials storage. Several municipalities have passed model ordinances covering the design, construction, and location of hazardous materials storage lockers. Design features can include, but are not limited to, the following:

- (1) Secondary spill containment sumps
- (2) Deflagration venting
- (3) Ventilation requirements, including mechanical ventilation where dispensing operations are expected
- (4) Electrical equipment for hazardous locations in accordance with *NFPA 70, National Electrical Code*
- (5) Static electricity control
- (6) Fire suppression systems (dry chemical or sprinklers)
- (7) Heavy structural design for the following:
  - (a) Security provisions
  - (b) Doors that lock and permit pallet loading
  - (c) Wind load, snow load, and storage load conditions
  - (d) Anchorage provisions
  - (e) Skid design, permitting relocation using lift trucks
- (8) Fire-related exterior walls, if required
- (9) Interior partitions to segregate incompatible materials
- (10) Size limits to limit quantities that can be stored within preassembled or ready-to-assemble designs
- (11) Nonsparking floors
- (12) Shelving, if required
- (13) Heating or cooling units, if needed
- (14) Corrosion protection as required
- (15) Employee safety provisions (eye/face wash)
- (16) *NFPA 704, Standard System for the Identification of the Hazards of Materials for Emergency Response*, hazard symbols

Features provided are determined by specific storage requirements and needs of the owner, keeping in mind applicable regulations and ordinances that apply and the approval requirements of the authority having jurisdiction.



Several testing laboratories have developed internal procedures for the examination, testing, and listing or labeling of hazardous materials storage lockers submitted by manufacturers.

**A.16.1.1** See Annex E for limitations of the protection criteria of Table 16.5.2.1 through Table 16.5.2.12, particularly for intermediate bulk containers and portable tanks having capacities greater than 60 gal (230 L).

Protected storage allowed under previous editions of this code can be continued if the class of liquids stored, the quantity of liquids stored, fire protection, and building configuration remain unchanged. Table A.16.1.1(a) and Table A.16.1.1(b), reprinted here from the 1993 edition of this code, can be used as a reference for storage arrangements in previously approved, protected, inside liquid storage areas.

For certain liquids such as ketones, esters, and alcohols, the minimum required densities established in the listing criteria for foam discharge devices are often higher than the general densities specified for protection of flammable and combustible liquids. When determining the design criteria for extinguishing systems using foam, it is important to ensure that the listing criteria, which are typically based on empirical data from fire tests, are not overlooked. Otherwise, the fire protection system design can be inadequate for proper protection.

Early suppression fast-response (ESFR) sprinklers have been tested for protection of liquids only to the extent reflected in the tables in Section 16.5. Any other use of ESFR sprinklers for protection of liquids should be based on an engineering analysis that evaluates the potential failure of the sprinkler system based on a rapid-growth fire or a large pool

fire that would operate more sprinklers than are accommodated by the design area. The use of ESFR protection, particularly without provisions for the control of spread of liquid, presents the possibility of a liquid pool fire that could exceed the limited design operating area of an ESFR system.

The information in Table 16.5.2.1 through Table 16.5.2.12 was developed from full-scale fire tests. Where only one K-factor sprinkler is allowed, this was the only size proven to provide fire control. Where a choice of K-factors is allowed by the tables, each was able to provide fire control; however, the larger K-factor sprinklers sometimes demonstrated better fire control and further limited fire damage. Where only one response-type of sprinkler is allowed, this is the only type of sprinkler proven to provide fire control. Where a choice of response characteristics (SR or QR) is allowed by the tables, each was able to provide fire control; however, the QR sprinklers sometimes demonstrated better fire control and further limited fire damage.

In the testing involving metal containers, only steel containers were tested. Other metal containers, such as aluminum, have not been tested.

**A.16.1.2** To date, there has been no full-scale testing to determine appropriate fire protection design criteria for Class IA liquids or unstable liquids.

**A.16.2.3** Table A.16.2.3 provides examples of commonly used metal containers that are considered either relieving style or non-relieving style for use in developing protected storage arrangements in accordance with Table 16.5.2.1 through Table 16.5.2.12.

**Table A.16.1.1(a) Storage Arrangements for Protected Palletized or Solid Pile Storage of Liquids in Containers and Portable Tanks**

Liquid Class	Storage Level	Maximum Storage Height (ft)		Maximum Quantity per Pile (gal)		Maximum Quantity* (gal)	
		Containers	Portable Tanks	Containers	Portable Tanks	Containers	Portable Tanks
IA	Ground floor	5	—	3,000	—	12,000	—
	Upper floors	5	—	2,000	—	8,000	—
	Basement	NP	NP	—	—	—	—
IB	Ground floor	6½	7	5,000	20,000	15,000	40,000
	Upper floors	6½	7	3,000	10,000	12,000	20,000
	Basement	NP	NP	—	—	—	—
IC	Ground floor	6½ †	7	5,000	20,000	15,000	40,000
	Upper floors	6½ †	7	3,000	10,000	12,000	20,000
	Basement	NP	NP	—	—	—	—
II	Ground floor	10	14	10,000	40,000	25,000	80,000
	Upper floors	10	14	10,000	40,000	25,000	80,000
	Basement	5	7	7,500	20,000	7,500	20,000
III	Ground floor	20	14	15,000	60,000	55,000	100,000
	Upper floors	20	14	15,000	60,000	55,000	100,000
	Basement	10	7	10,000	20,000	25,000	40,000

For SI units, 1 ft = 0.3 m; 1 gal = 3.8 L.

NP: Not permitted.

\*Applies only to cut-off rooms and attached buildings.

†These height limitations can be increased to 10 ft for containers of 5 gal capacity or less.

**Table A.16.1.1(b) Storage Arrangements for Protected Rack Storage of Liquids in Containers and Portable Tanks**

Liquid Class	Type Rack	Storage Level	Maximum Storage	
			Height of Containers (ft)	Maximum Quantity of Containers (gal)*†
IA	Double row or single row	Ground floor	25	7,500
		Upper floors	15	4,500
		Basement	NP	—
IB IC	Double row or single row	Ground floor	25	15,000
		Upper floors	15	9,000
		Basement	NP	—
II	Double row or single row	Ground floor	25	24,000
		Upper floors	25	24,000
		Basement	15	9,000
III	Multirow, double row, or single row	Ground floor	40	55,000
		Upper floors	20	55,000
		Basement	20	25,000

For SI units, 1 ft = 0.3 m; 1 gal = 3.8 L.

NP: Not permitted.

\*Maximum quantity allowed on racks in cut-off rooms and attached buildings.

†Maximum quantity allowed per rack section in liquid warehouses.

**Table A.16.2.3 Common Relieving- and Nonrelieving-Style Metal Containers**

Container Type	Relieving Style	Nonrelieving Style
≤1 qt <sup>a</sup>	All	N/A
>1 qt and ≤6 gal <sup>a</sup>	Metal containers with plastic cap, or flexible or rigid plastic spout with plastic cap	Metal containers with steel spout and steel screw cap
≤1 gal, friction lid	Metal containers with metal friction-fit covers (e.g., paint can lid)	N/A
1 gal and ≤6 gal (lug cover)	Metal containers with metal covers held in place with a mechanical friction-fit (e.g., lug-type) closure mechanism	N/A
>6 gal and ≤60 gal <sup>b,c</sup> (drums)	Metal containers, tight or open-head (drums) having at least one 2 in. plastic plug (Note: Cap seals, if used, need to be plastic and nonmetallic.)	Open head metal containers with steel covers having no steel flange openings; or open head and tight head metal containers with steel flange openings where only steel plugs and/or cap seals are used
>60 gal and ≤793 gal	Metal portable tanks or metal intermediate bulk containers with at least one relief device conforming to the design, construction, and capacity of the container's section	N/A

For SI units, 1 gal = 3.8 L., 1 qt = 1 L.

N/A: Not applicable.

<sup>a</sup>All containers ≤1 qt are considered relieving style because their failure is inconsequential.

<sup>b</sup>In full-scale fire tests, where containers were provided with both ¾ in. (19 mm) and 2 in. (50 mm) relieving vent openings and, in some cases, both vents were obstructed by pallet slats, rupture of containers did not occur. Because it is not possible to determine if all conceivable obstruction scenarios were represented, where drums are stacked more than one high, provide an additional ¾ in. (19 mm) or 2 in. (50 mm) pressure-relieving mechanism.

<sup>c</sup>The use of plastic plugs instead of steel plugs (bungs) in a steel drum in order to achieve a relieving-style container should contemplate the following issues in order to assure the safe storage of liquids:

- (1) The compatibility of the plastic plug materials and gaskets with the liquids being stored.
- (2) The stability and shelf life of the liquids being stored as the plastic plugs can admit water vapor, oxygen, and light.
- (3) The difference in expansion coefficients for plastic plugs and steel drums for those drums subject to temperature variations and hot or cold conditions.
- (4) The tooling issues involved with the use of plastic plugs as the torque levels are different from those levels used for steel plugs.
- (5) The training of fill line operators in order to avoid cross-threading and/or the stripping of threads.
- (6) The voiding of the United Nations (UN) rating on the steel drum by installing plastic plugs. If the user needs to install a plug other than the one originally provided by the container manufacturer, then the user should contact the manufacturer to ensure that the UN rating will still be valid.



**A.16.2.4** Unsaturated polyester resins (UPRs) are high molecular weight unsaturated polymers dissolved in a reactive monomer, usually styrene, in concentrations of 50 percent or less by weight. UPRs are combined with reinforcements such as fiberglass and/or fillers to produce a wide range of products. Examples of such products include automobile parts, bathroom tubs and shower stalls, cultured marble, and many products for architectural, recreational, construction, and corrosion-resistant applications. UPRs are normally packaged in 55 gal (208 L) drums. The U.S. Department of Transportation classification for UPRs is “UN 1866, Resin Solution”; however, it should be noted that this classification includes many materials that are not unsaturated polyester resins.

**A.16.5.1.6.2** Most fire tests using foam-water protection schemes have been conducted with immediate foam solution discharge from the operating sprinklers. If an appreciable delay is encountered before properly proportioned foam is discharged, control of the fire might not be established. One method of accomplishing immediate foam solution discharge is by using an in-line balanced pressure (ILBP) proportioning system.

**A.16.6.1.5** The 8 ft (2.4 m) separation distance required in 16.6.1.5 is measured from the face of liquid storage in one rack to the face of liquid storage and/or other storage across the aisle in an adjacent rack. Rack designers, code officials, and plan reviewers are cautioned to the fact that many rack storage arrangements involve the storage of pallets that overhang the face of the rack. Therefore, although the structural rack members might be arranged to have an 8 ft (2.4 ft) aisle between the racks, the distance between the face of the stored materials in the racks could be less than 8 ft (2.4 ft) when the racks are filled with pallets. This will not be in compliance with the requirements of 16.6.1.5, unless the barrier and in-rack sprinkler protection is extended.

**A.16.8.2** Section 16.8 requires that control of liquid spread be provided to prevent a pool fire on the floor from spreading and opening more sprinkler heads than the design of the sprinkler system anticipates. For example, if the sprinkler system is designed to provide 0.45 gpm/ft<sup>2</sup> over 3000 ft<sup>2</sup> (18 mm/min over 280 m<sup>2</sup>), 16.8.2 requires that the spread of liquid also be limited to 3000 ft<sup>2</sup> (280 m<sup>2</sup>). Various means are available to achieve this control.

Typical methods use trench or spot drains that divide the floor of the storage area into rectangles having areas equal to

or less than the design area of the sprinkler system. Drains are centered under racks, and the floor is sloped toward the drain trenches with a minimum slope of 1 percent. The floor is made highest at the walls. See Figure A.16.8.2(a) and Figure A.16.8.2(b). Trenches are arranged as described in NFPA 15, *Standard for Water Spray Fixed Systems for Fire Protection*, and as shown in Figure A.16.8.2(c). Note particularly the dimensions of the trenches, and note that the solid covering spans one-third of the width on either side of the open grate and the open grate spans the middle third. Spot drains can be similarly arranged. Another method, shown in Figure A.16.8.2(d), uses spot drains located at building columns, where the area between any four columns does not exceed the design area of the sprinkler system. The floor is sloped to direct water flow to the drains.

Connections to the drains are provided at trapped sumps, arranged as described in NFPA 15. See Figure A.16.8.2(e). To provide a safety factor, the drain pipes are sometimes sized to carry 150 percent of anticipated sprinkler discharge. The following equation can be used to calculate the flow of the drain pipe:

$$F = 1.5DA \quad [\text{A.16.8.2}]$$

where:

$F$  = flow (gpm or L/min)

$D$  = sprinkler design density (gpm/ft<sup>2</sup> or L/min/m<sup>2</sup>)

$A$  = sprinkler design area (ft<sup>2</sup> or m<sup>2</sup>)

Additional information can be found in *Guidelines for Safe Warehousing of Chemicals*, Center for Chemical Process Safety, American Institute of Chemical Engineers.

**A.17.1.1** Facilities designed in accordance with Chapter 17 do not use the maximum allowable quantity and control area concepts found in the building code.

**A.17.3.1** Information on the location of processing operations can be found in API RP 752, *Management of Hazards Associated with Location of Process Plant Buildings*, and API RP 753, *Management of Hazards Associated with Location of Process Plant Portable Buildings*.

**A.17.4.3.1** Minimum distances provided in Table 17.4.3 are extracts from similar tables in Chapter 22. Process vessels are at greater risk of upset and experience a wider range of process parameters (e.g., flow, temperature, pressure, level, reactivity, vapor density, and potential for vapors to reach ignition sources if released) when compared to storage

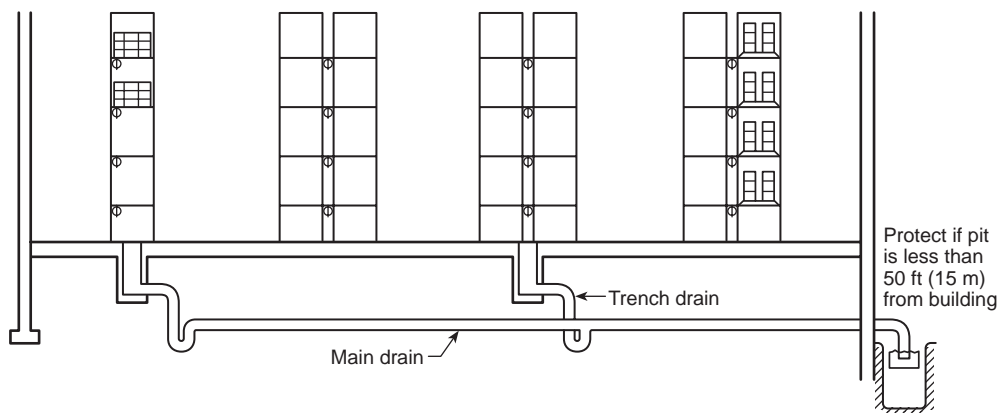

**FIGURE A.16.8.2(a) General Scheme for Warehouse Spill Control of Liquids.**



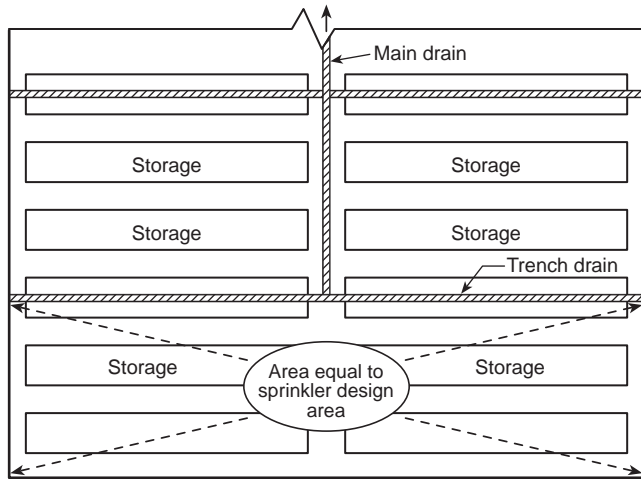

FIGURE A.16.8.2(b) Plan View of Warehouse Spill Control of Liquids.

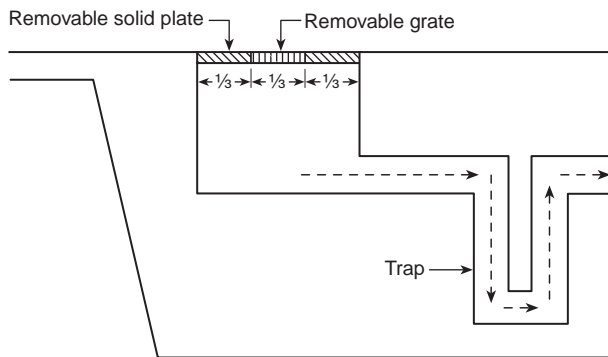

FIGURE A.16.8.2(c) Details of Drainage Trench Design.

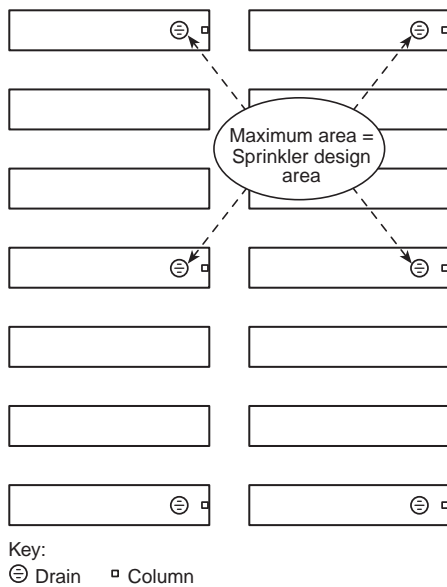

FIGURE A.16.8.2(d) Typical Arrangement of Floor Drains.

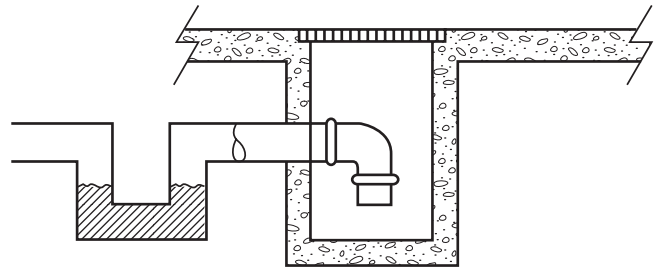

FIGURE A.16.8.2(e) Details of Liquid-Seal Trap.

tanks. Evaluations for minimum distance should take these factors into account and establish the “stability” of the material and the maximum pressure in the vessel(s), taking into consideration credible process deviations and the design and reliability of safeguards that prevent or control process upsets. Minimum distances to property lines, important buildings, and public ways should consider the risk (i.e., likelihood and consequence) to persons, property, and adjacent processes and storage from vapor cloud ignition, blast overpressure, and thermal flux (i.e., burn injury and adjacent structure fire). See also 17.15.3.

Additional guidance can be found in the following documents:

- (1) NFPA 497, *Recommended Practice for the Classification of Flammable Liquids, Gases, or Vapors and of Hazardous (Classified) Locations for Electrical Installations in Chemical Process Areas*
- (2) NFPA 551, *Guide for the Evaluation of Fire Risk Assessments*
- (3) AIChE *Guidelines for Evaluating Process Plant Buildings for External Explosions and Fires*
- (4) AIChE *Guidelines for Facility Siting and Layout*
- (5) AIChE *Guidelines for Vapor Cloud Explosion, Pressure Vessel Burst, BLEVE and Flash Fire Hazards*
- (6) SFPE *Handbook of Fire Protection Engineering*
- (7) SFPE *Engineering Standard on Calculating Fire Exposures to Structures*
- (8) SFPE *Engineering Guide: Predicting 1st and 2nd Degree Skin Burns from Thermal Radiation*
- (9) SFPE *Engineering Guide to Fire Exposures to Structural Elements*
- (10) SFPE *Engineering Guide: Assessing Flame Radiation to External Targets from Pool Fires*
- (11) API RP 500, *Recommended Practice for Classification of Locations for Electrical Installations at Petroleum Facilities Classified as Class I, Division 1 and Division 2*
- (12) ANSI/API RP505, *Recommended Practice for Classification of Locations for Electrical Installations at Petroleum Facilities Classified as Class I, Zone 0, Zone 1 and Zone 2*
- (13) API RP752, *Management of Hazards Associated with Location of Process Plant Buildings*
- (14) API RP753, *Management of Hazards Associated with Location of Process Plant Portable Buildings*

**A.17.4.6** Equipment operated at gauge pressures that exceed 1000 psi (6900 kPa) might require greater spacing.

**A.17.6.8** API 2218, *Fireproofing Practices in Petroleum and Petrochemical Processing Plants*, contains guidance on selecting and installing fire-resistant coatings to protect exposed steel supports from a high-challenge fire exposure. It also contains a general discussion on determining need for such protection and estimating the extent of the area exposed.

**A.17.6.10** NFPA 204, *Standard for Smoke and Heat Venting*, provides information on this subject.

**A.17.6.11** NFPA 101, *Life Safety Code*, provides information on this subject.

**A.17.10.1** This might require curbs, scuppers, or special drainage systems to control the spread of fire. Annex A of NFPA 15, *Standard for Water Spray Fixed Systems for Fire Protection*, provides information on this subject.

**A.17.11.2** Equipment in enclosed processing areas can deteriorate over time, and periodic evaluation should be conducted to ensure that leakage rates have not increased or that the ventilation rate is adequate for any increase in leakage rates.

**A.17.11.7** NFPA 91, *Standard for Exhaust Systems for Air Conveying of Vapors, Gases, Mists, and Noncombustible Particulate Solids*, and NFPA 90A, *Standard for the Installation of Air-Conditioning and Ventilating Systems*, provide information on this subject.

**A.17.14** Where the vapor space of equipment is usually within the flammable range, the probability of explosion damage to the equipment can be limited by inerting, by providing an explosion suppression system, or by designing the equipment to contain the peak explosion pressure that can be modified by explosion relief. Where the special hazards of operation, sources of ignition, or exposures indicate a need, consideration should be given to providing protection by one or more of the above means.

See NFPA 68, *Standard on Explosion Protection by Deflagration Venting*, and NFPA 69, *Standard on Explosion Prevention Systems*, for additional information on various methods of mitigating losses from explosions.

**A.18.4.8** The process area is not intended to be a storage area for liquid containers. However, it is recognized that containers will be brought into the process area either for transfer of liquids to the process or for dispensing liquids from the process to the containers.

The amount of liquid in containers in the process area should be limited as much as possible. Full containers should not be stored in the process area but can be staged there. Only the amount of liquid needed for one continuous 24-hour period should be brought into the process area in full containers. Partial containers can remain in the process area as long as they do not increase the hazard present. Containers that were filled in the process area can remain there during the shift that they were filled but should be relocated to the appropriate storage area before the end of the workday or shift in the case of 24-hour-a-day operations.

**A.18.5.1** Incidental operations are operations that utilize liquids only as a limited activity to that which establishes the occupancy classification. Examples include automobile assembly, assembly of electronic equipment, furniture manufacturing, and areas within refineries, distilleries, and chemical plants where the use of liquids is incidental, such as in maintenance shops, offices, or vehicle repair shops. Some more detailed descriptions follow:

(1) *Vehicle Assembly*. Vehicle assembly operations usually involve both process and incidental use of liquids. An example of a process operation would be paint storage and mixing utilized for application of the vehicle primer, color coats, and clear coats. For these operations, the requirements of Chapter 17 apply. Examples of incidental

use would be sealer deck wipedown operations, wind-shield washer solvent dispensing, brake fluid filling, and final line paint repair operations. These operations might be continuous. However, the quantities of liquids used and the vapor exposures are significantly reduced from larger volume usage found within vehicle body component paint mixing and storage operations.

- (2) *Assembly of Electrical Equipment*. Examples of incidental use of liquids in these types of occupancies might include “photoresist” coating operations, “softbaking” operations, wave solder operations, and wipedown operations.
- (3) *Chemical Plant Maintenance Shop*. Incidental use of liquids is commonplace in maintenance shops located within a chemical plant. Examples are cutting oils used in a machine shop, Class II solvents for degreasing, and Class I and II paint solvents and fuels associated with automotive and industrial truck repair.
- (4) *Cleaning and Sanitation*. Under provisions established by the U.S. Food and Drug Administration (FDA) in 21 CFR, “GMP for Medical Devices,” Class I and Class II liquids can be used for cleaning and sanitation purposes. Limited quantities are used to remove manufacturing materials, mold release compounds, and other contaminants not intended to be on the final product. An example would be the use of isopropyl alcohol (IPA), transferred to a cleaning wipe via a plunger-type liquid-dispensing container. The cleaning wipe is then used to remove manufacturing materials not intended to be on the final product. The key point here is not that the liquid is not part of the final product, but that limited quantities of liquid are used and the use is incidental to the manufacturing operation that produces the product.

**A.18.5.4.1(1)** The intent of this requirement is to allow the quantities of flammable and combustible liquids needed to safely and efficiently operate for the actual operating hours in any 24-hour period. As an example, if the facility operates only 8 hours out of 24 (i.e., a single shift) and uses 50 gal (190 L) of liquid during that time, then 50 gal (190 L) is the allowable quantity for the continuous 24-hour period. If the facility increases operations to two shifts, then the allowable quantity doubles to 100 gal (380 L).

**A.18.5.6(3)** NFPA 91, *Standard for Exhaust Systems for Air Conveying of Vapors, Gases, Mists, and Noncombustible Particulate Solids*, provides information on the design and installation of mechanical ventilation.

**A.18.6.3** A “safe location” should be selected as the location of a vent discharge to minimize the potential for ignitable vapors to travel to a source of ignition after discharge from the vent. Electrical equipment that does not meet the requirements for hazardous locations can serve as an ignition source. The Technical Committee advises that vent discharge locations should consider such factors as the following:

- (1) Characteristics of the exhausted material (vapor density, toxicity, velocity of discharge, etc.)
- (2) Proximity to potential ignition sources
- (3) Building openings such as doors, windows, air intakes, and so forth
- (4) Dispersion characteristics (distance to discharge within the flammable range, direction of discharge, atmospheric conditions, and the influence of building and neighboring buildings on discharged vapors)
- (5) Likelihood of vapor accumulation following discharge, such as accumulation under building eaves

- (6) Likelihood of sufficient discharge volume to allow an ignitable concentration to reach an ignition source

Historically, NFPA 30 has provided prescriptive guidance, often based on area classification requirements, and results have been acceptable. Closer distances should be accepted only if an engineering study by a qualified engineer justifies closer distances. Similarly, the specified distances might not be acceptable for all installations, thus the guidance provided above.

**A.19.2.1** Cooking oil is a Class IIIB liquid with a high flash point typically above 500°F (260°C). Because of its high flash point, cooking oil presents a lower fire hazard than Class IIIB liquids having flash points lower than 500°F (260°C). Fresh, or new, cooking oil is supplied to the user for cooking operations. As the oil becomes degraded through repeated use, it must be replaced with fresh oil. This waste, or used, cooking oil is recovered from the cooking appliance and temporarily stored for offsite removal. To maintain fluidity in the transfer process, the waste oil is heated to approximately 100°F (38°C), well below the flash point temperature.

**A.19.4.2** Mist explosions have occurred when heat transfer fluid that is above its boiling point has been released in an enclosed area. Consideration should be given to locating heaters or vaporizers either in a detached building or in a room with damage-limiting construction.

**A.19.4.3** The system should be interlocked to stop circulation of the heat transfer fluid through the system and to shut off the system heater or vaporizer in the event of a fire, abnormally low pressure in the system, or operation of an approved heat detection system. Where the refractory inside the heater or vaporizer can retain enough heat to cause either breakdown of the heat transfer fluid or tube fouling if fluid circulation through the unit is stopped, circulation could have to be continued. In the event of a confirmed fire, it is desirable to subdivide the piping system by means of interlocked safety shutoff valves. A practical way of accomplishing this is to isolate all secondary circulating loops from the primary loop that runs into and out of the vaporizer or heater.

A well-marked remote emergency shutoff switch or electrical disconnect should be provided to shut down the entire system in the event of an emergency. This should be located either in a constantly attended location or at a location that would be accessible in the event of a leak or a fire.

If there are any process or utility lines running in or through rooms or areas containing parts of the heat transfer system, consideration should be given to providing emergency shutoff valves. They should be located so they are readily accessible in the event of a fire.

Where the liquid level in the system expansion tank is maintained by an automatically actuated supply pump taking suction from the heat transfer fluid storage tank, an interlock should be provided to shut down the supply pump when a high level indicator is actuated, regardless of whether the pump is in automatic or manual mode.

**A.19.4.3.1** Heat transfer fluid systems have the potential for releasing large quantities of heated flammable or combustible liquid. Low-point drains piped to a safe location provide the ability to remove heat transfer fluid from a breached piping system in order to minimize the total quantity of fluid released. An engineering analysis should be used to determine the location and design of low-point drains. The engineering analysis should consider system inventory, the amount of heat transfer fluid that can

be released in a specific fire area, the exposure created by a release, and the fire protection provided.

**A.19.4.3.2** Where possible, the drain tank(s) should be located below the lowest system drain opening to permit gravity flow. Breather vents should be provided based on the maximum emptying or filling rates.

**A.19.4.4** If stack gas from a heater or vaporizer is recovered to provide auxiliary heat for other equipment (e.g., rotary dryers), suitable dampers, isolation gates, burner control logic, or other means should be provided to ensure that all equipment is properly purged and will operate in a safe manner. The control logic should anticipate all possible operating modes of the individual pieces of equipment, whether operating singly or together, to ensure safe startup and shutdown under normal or upset conditions.

Instrumentation and interlocks should be provided to sound an alarm and to automatically shut down the fuel source to the heater or vaporizer when any of the following conditions are detected:

- (1) Low flow of heat transfer fluid through the heat exchange tubes of the heater, as measured at the discharge.
- (2) High temperature or pressure of the fluid at the heater or vaporizer outlet. The high-temperature interlock should be set at or below the manufacturer's maximum recommended bulk fluid temperature.
- (3) Low pressure at the heater or vaporizer outlet or elsewhere in the system. This interlock could require a bypass to allow for startup.
- (4) Low fluid level in the expansion tank.
- (5) Low liquid level in the vaporizer.
- (6) Sprinkler system flow in any area containing the heat transfer equipment or piping.

Alarm set points should be provided at levels below or above the automatic shutoff setpoints to monitor the above-mentioned variables and provide an opportunity for operators to correct the problem before conditions reach an unsafe level.

**A.19.4.5.1** Where possible, piping should be run underground, outside, or in floor trenches. Overhead routing of heat transfer fluid piping should be minimized.

**A.19.4.6.1** Historical records show that fires involving heat transfer fluids can be very severe and long lasting. It is recommended that automatic sprinkler or deluge protection be provided throughout all building areas potentially exposed to a heat transfer fluid spill fire.

**A.19.4.7.1** Some factors that should be considered as part of such a review include the following:

- (1) Infiltration of material being heated into the heat transfer system. In this case, the system should be shut down and the internal leak point found and repaired as soon as possible.
- (2) Leaks in the system. Any leak should be corrected promptly regardless of how small. Corrections should be permanent, such as repacking valve stems and replacing leaky gaskets. Any heat transfer fluid released as a result of a leak or operation of a safety valve should be cleaned up immediately if it is or can come in contact with a hot surface. Other spills can be cleaned up at the first available opportunity.



- (3) Pipe or equipment insulation that is soaked with heat transfer fluid. In this case, the cause of the leak should be corrected promptly and the insulation replaced with clean, dry insulation.
- (4) High temperature anywhere in the system. In this case, operating procedures should specify shutdown of the heater or vaporizer fuel supply as soon as the temperature of the heat transfer fluid exceeds the manufacturer's recommended maximum bulk fluid temperature. Any corrective actions taken to correct a high temperature condition should only be done with the heat source shut off.

**A.19.5.5.1** If the liquid knock-out vessel utilizes a pump for automatic liquid removal, consideration should be given to a low-level alarm and shutdown to avoid running the pump dry, resulting in a potential source of ignition.

**A.19.5.7.2** Electrical enclosures that need to be opened frequently for maintenance (i.e., enclosures housing vapor processing system controls) have a higher potential for mechanical damage that could render the enclosures unable to contain an explosion. Additional inspection could be needed to ensure the integrity of the enclosure.

**A.19.5.7.3** NFPA 77, *Recommended Practice on Static Electricity*, and API 2003, *Protection Against Ignition Arising Out of Static, Lightning, and Stray Currents*, can be used as a reference for protections against static ignition.

**A.19.5.7.4** Spontaneous ignition can be a problem in the following:

- (1) Facilities where pyrophoric deposits can accumulate from the handling of oxygen-deficient vapors containing sulfur compounds or asphaltic materials. When air is introduced into the system, the pyrophoric materials can react, resulting in potential ignition and fire.
- (2) Facilities that handle fluids in such a way that mixing of hypergolic or otherwise incompatible materials can occur. Such mixing could occur with fluids remaining in the vapor recovery system from prior loading activities.
- (3) Facilities handling oxygenated hydrocarbons in carbon absorption units. Higher heats of absorption for these types of vapors can potentially lead to overheated carbon beds and increase the chance that an oxidation reaction can be initiated. (For further information, refer to API Report, "An Engineering Analysis of the Effects of Oxygenated Fuels on Marketing Vapor Recovery Equipment.")

**A.19.5.7.5** U.S. Coast Guard Regulations in Title 33, Code of Federal Regulations, Part 154, Section 154.826(b), (c), and (d), can be used as a reference for vapor mover designs that minimize the potential for ignition.

**A.19.5.7.6** The potential for ignition in the vapor collection system needs to be evaluated on a case-by-case basis. If ignition occurs, flame propagation in piping systems containing vapor mixtures in the flammable range normally starts with low-speed burning (deflagration). As the flame moves through the piping, it accelerates and, within a short distance, can reach supersonic speeds (detonation). Initial low-speed flame propagation can be stopped by flame arresters, liquid seals, or automatic fast-acting valve systems where designed, operated, and tested within the requirements of NFPA 69, *Standard on Explosion Prevention Systems*. Flame propagation can also be stopped for both deflagrations and detonations by use of detonation arresters tested in accordance with U.S. Department of

Transportation Coast Guard Regulations of the 33 CFR 154, Appendix A, or other procedures acceptable to the authority having jurisdiction, or automatic fast-acting valve systems tested under the appropriate conditions.

**A.19.7.1.3** The goal of Section 19.7 is to consolidate in one location all requirements for commercial kitchen cooking oil storage and operations. There are a number of chapters in NFPA 30 that apply to these systems, including chapters on storage tanks and piping systems, transferring and dispensing of liquids, and so forth. Many of these requirements are more applicable to industrial or process situations and commercial kitchen cooking oil storage and use was not anticipated. All applicable chapters have been assessed in detail. Those specific requirements in this section that are in potential conflict with other sections of this code have been identified and alternate methods or exceptions have been developed where appropriate. This approach eliminates the need to add exceptions throughout the existing code, improving ease of use particularly for fire officials.

**A.19.7.2.1.2** Waste oil is drained from commercial cooking equipment via a transfer pump and transfer lines to a waste oil storage tank. The oil might be as hot as 375°F (190°C), still well below the oil's flash point. Experience shows that the oil loses significant heat in the transfer process. The maximum temperature of waste cooking oil entering the storage tank is typically below 235°F (113°C). The storage tank should be constructed of materials compatible with cooking oil in that temperature range.

**A.19.7.2.2.1** Existing steel tanks listed for flammable and combustible liquids are considered acceptable for waste oil use. These tank standards contain design and construction requirements that would not meet food code requirements, making the tanks unacceptable for storage of liquid food products (i.e., fresh cooking oil).

**A.19.7.2.3.4** High flash point cooking oils do not create ignitable vapors when stored under the conditions specified in Section 19.7.

**A.19.7.2.4.2** Nonmetallic tanks will melt above the liquid level as an external exposure fire progresses, venting the vapor space of the tank.

**A.19.7.2.5** Although generally not required for tanks storing Class IIIB liquids, overfill protection is considered necessary for cooking oil storage tanks to prevent inadvertent spillage.

**A.19.7.2.6.1** The prohibition of electrical immersion heaters in nonmetallic tanks eliminates a primary ignition source for the oil stored in the tank.

**A.19.7.2.6.2** The temperature limitation of 140°F (60 °C) corresponds to ASTM C 1055 (ISO 13732-1) restrictions for maximum allowable temperatures of nonmetallic industrial surfaces for human contact.

**A.19.7.3.1.1** The kitchen cooking area has historically been an area where fires occur. Tanks should, therefore, be located away from the kitchen cooking area.

**A.19.7.3.1.2** The area beneath the ventilation hood is another area of potential accidental ignition.

**A.19.7.3.3.2** An example of a fitting with a positive shutoff is a spring-loaded check valve or a hydraulic quick-coupling with a spring-loaded poppet.

**A.19.7.3.4.1** Cooking oil storage tanks are atmospheric tanks with open vents. The requirement in Chapter 21 to pressurize the tank for leak testing would be difficult to achieve in the field, due to tank construction and configuration. It is also desirable to prevent water contamination of the cooking oil. A more appropriate test would be to fill the tank with cooking oil to cover all connections and seams below the normal liquid level.

**A.19.7.4.2** Supplemental ventilation, as is required for cooking operations, is not needed for cooking oil storage tanks.

**A.19.7.5.1** Waste oil lines are generally pumped until there is little residual oil remaining in the lines. Fresh cooking oil lines are likely to contain residual oil after fill and removal operations. Restricting the fresh oil line size to 1.25 in. (32 mm) maximum inside diameter limits the amount of oil in the line. Additionally, the requirement for check valves or antisiphon valves on the lines at points where the lines connect to the tank eliminates the possibility of a compromised line siphoning the contents of the tank. To the extent possible, transfer lines should avoid being routed over seating areas. These requirements are designed to minimize fire risk by limiting cooking oil quantities in transfer lines that could become involved in a fire. In buildings protected by automatic sprinklers, the need to add sprinklers in previously unprotected spaces (assuming the transfer lines are located in these spaces) should be considered in accordance with the requirements of NFPA 13, *Standard for the Installation of Sprinkler Systems*.

**A.19.7.5.2** The temperature and pressure ratings for the waste oil lines are consistent with the maximum expected conditions.

**A.21.4.2.1.1** Atmospheric tanks include tanks of compartmented design and tanks that incorporate secondary containment.

**A.21.4.2.3.2** Such pressure vessels are generally referred to as “state special.”

**A.21.4.3.2** Normal venting is not required for the interstitial space of a secondary containment tank.

**A.21.4.3.11** Liquid properties that justify omitting such devices include, but are not limited to, condensation, corrosiveness, crystallization, polymerization, freezing, or plugging. When any of these conditions exist, consideration should be given to heating, use of devices that employ special materials of construction, use of liquid seals, or inerting. See NFPA 69, *Standard on Explosion Prevention Systems*.

**A.21.4.4** In Exception No. 2, examples of liquids with minimal potential for accumulation of static charge include crude oil, asphalt, and water-miscible liquids. For additional information, see NFPA 77, *Recommended Practice on Static Electricity*.

**A.21.4.5** Other means of internal corrosion protection include protective coatings and linings and cathodic protection.

**A.21.5.2** See PEI RP200, *Recommended Practices for Installation of Aboveground Storage Systems for Motor Vehicle Fueling*, and STI R931, *Double Wall AST Installation and Testing Instructions*, for additional requirements to test secondary containment tanks.

**A.21.5.2.7** Underground double-wall tanks can be considered to be a type of secondary containment. The terms “double-wall tank” and “jacketed tank” are sometimes used to describe underground secondary containment tanks.

**A.21.5.3** For information on testing of underground tanks, see NFPA 329, *Recommended Practice for Handling Releases of Flammable and Combustible Liquids and Gases*. For information on testing aboveground tanks, see API 653, *Tank Inspection, Repair, Alteration, and Reconstruction*.

**A.21.6.5.1** Resources include, but are not limited to, the following:

- (1) Mutual aid
- (2) Water supply
- (3) Extinguishing agent supply

**A.21.6.6.1** See NFPA 25, *Standard for the Inspection, Testing, and Maintenance of Water-Based Fire Protection Systems*, or other specific fire protection system standards.

**A.21.7.1** Further guidance is given in API 2350, *Overfill Protection for Storage Tanks in Petroleum Facilities*.

**A.21.7.2.2** Protection from tampering or trespassing might include one or more of the following: appropriate fencing around isolated tanks in remote areas; “No Trespassing” signs; warning signs indicating the fire hazard of the tank or its contents; locked or secured access to stairways and ladders; locked or secured hatches, valves, and so forth.

**A.21.7.4.1** For further information, see API 2015, *Cleaning Petroleum Storage Tanks*; and API 2016, *Guidelines and Procedures for Entering and Cleaning Petroleum Storage Tanks*.

**A.21.7.4.3.3(2)** Special training might be required.

**A.21.7.5** See NFPA 329, *Recommended Practice for Handling Releases of Flammable and Combustible Liquids and Gases*, for information on testing methods.

**A.21.8.1** Regular inspections of aboveground storage tanks, including shop fabricated aboveground storage tanks, performed in accordance with national standards, provide a means to ensure system maintenance. Acceptable standards include, but are not limited to, the following:

- (1) API 653, *Tank Inspection, Repair, Alteration, and Reconstruction*
- (2) STI SP001, *Standard for Inspection of Aboveground Storage Tanks*
- (3) API 12R1, *Setting, Maintenance, Inspection, Operation, and Repair of Tanks in Production Service*
- (4) API RP2350, *Overfill Protection for Storage Tanks in Petroleum Facilities*

**A.21.8.6** For additional information, see API 653, *Tank Inspection, Repair, Alteration, and Reconstruction*, API RP 2350, *Overfill Protection for Storage Tanks in Petroleum Facilities*, and PEI RP600, *Recommended Practices for Overfill Prevention for Shop-Fabricated Aboveground Tanks*.

**A.21.8.8** The accumulation of water in the bottom of a tank encourages microbial activity that hampers operations and increases the risk of product release. It is imperative that tank owners and operators routinely monitor the tank bottom for accumulation of water and establish a procedure for when and how the water is to be removed. Additional information can be found in API 1501, *Filtration and Dehydration of Aviation Fuels*, API RP 1621, *Bulk Liquid Stock Control at Retail Outlets*, and API Standard 2610, *Design, Construction, Operation, Maintenance, and Inspection of Terminal and Tank Facilities*. Other sources of information are ASTM D 6469, *Standard Guide for Microbial Contamination in Fuels and Fuel Systems*, the National Oilheat



Research Alliance *Oilheat Technician's Manual*, and the STI publication *Keeping Water Out of Your Storage System*.

**A.22.4** See PEI RP200, *Recommended Practices for Installation of Aboveground Storage Systems for Motor Vehicle Fueling*, for additional information.

**A.22.4.2.1** Where more than two tanks are involved, the sum of the diameters of each possible pair of tanks is calculated. For example, assume four tanks in a common diked area, numbered 1 through 4 clockwise from tank #1. The diameter of each pair of tanks is summed, as follows: 1 and 2, 1 and 3, 1 and 4, 2 and 3, 2 and 4, and 3 and 4.

**A.22.5.2.1** Appendix E of API Standard 650, *Welded Steel Tanks for Oil Storage*, and Appendix B of API 620, *Recommended Rules for the Design and Construction of Large, Welded, Low-Pressure Storage Tanks*, provide information on tank foundations.

**A.22.5.2.4** For further information, see ASTM E 119, *Standard Test Methods for Fire Tests of Building Construction and Materials*, and ANSI/UL 1709, *Standard for Rapid Rise Fire Tests of Protection Materials for Structural Steel*.

**A.22.7.3.1** An engineering evaluation should be performed whenever two-phase flow is anticipated. The objective of the engineering evaluation determining emergency vent requirements and design of the relief system is to protect against catastrophic failure resulting in unacceptable risk to persons or to the facility. Factors that should be included in the evaluation are as follows:

- (1) Properties of the materials including evaluated influence of two-phase flow and thermally induced instability. See the following references from the Design Institute for Emergency Relief Systems of the Center for Chemical Process Safety/American Institute of Chemical Engineers:
  - (a) Fisher, H. G. and Forrest, H. S., "Protection of Storage Tanks from Two-Phase Flow Due to Fire Exposure"
  - (b) Houser, J., et al, "Vent Sizing for Fire Considerations: External Fire Duration, Jacketed Vessels, and Heat Flux Variations Owing to Fuel Consumption"
  - (c) *Guidelines for Pressure Relief and Effluent Handling Systems*
- (2) Rate of heat input to the tank and contents. Computer models such as PLGS (supported by the UK Health and Safety Executive) can be useful in making the analysis.
- (3) Fire duration. For pool fires this analysis can be based on burning rate and pool depth. Computer programs can be useful in making this analysis.

**A.22.7.3.3** The formula shown in 22.7.3.3 is based on the following:

$$Q = 21,000(A)^{0.82} \quad [\text{A.22.7.3.3}]$$

where:

$$Q = \text{Btu/hr}$$

$$A = \text{ft}^2$$

**A.22.7.3.6** The provisions of 22.7.3.6 and 22.7.3.7 are based on full-scale testing that demonstrated that ethyl alcohol and liquids having similar burning characteristics required less emergency venting capacity.

Ethyl alcohol (ethanol) has a heat of combustion of 11,550 Btu/lb (26.8 mJ/kg) and a rate of burning of 0.000626 lb/ft<sup>2</sup>/sec (0.015 kg/m<sup>2</sup>/sec). The burning rate was calculated based on pan pool fires of diameters between 0.2 m (0.7 ft) and 5.0 m (16.5 ft). The pool fires were

burning at steady state in a wind-free environment. The ratio of the lip height of the pan (freeboard) to the diameter of the pan was approximately 0.06. Details of these tests can be found in "Fire Tests of Distilled Spirit Storage Tanks," Client Report CR-5727.1, for the Association of Canadian Distillers.

**A.22.7.3.7** See A.22.7.3.6.

**A.22.7.3.10.4** The following is a suitable formula for this calculation:

$$CFH = 1667C_f A \sqrt{P_t - P_a} \quad [\text{A.22.7.3.10.4}]$$

where:

CFH = venting requirement (ft<sup>3</sup> of free air per hour)

$C_f$  = flow coefficient of 0.5

$A$  = orifice area (in.<sup>2</sup>)

$P_t$  = absolute pressure inside the tank (in. of water)

$P_a$  = absolute atmospheric pressure outside the tank (in. of water)

**A.22.7.4** Vent sizing formulae and prescriptive vent sizes, such as those established by ANSI/UL 142, *Standard for Steel Aboveground Tanks for Flammable and Combustible Liquids*, are typically based on the direct installation of a venting device on to a tank with a nipple not exceeding 12 in. (300 mm). When the outlet of a vent must be extended to a remote location, such as for tanks located in buildings, which require vent discharges to be located outside, a significant reduction in vent flow can occur unless the size of the vent and connecting piping is increased. In such cases, the size of vents and vent pipe extensions should be calculated to ensure that a tank will not be overpressurized during a fire exposure.

**A.22.8.1** Protection against fire or explosion required for large flammable liquid storage tanks should consider the use of a fixed, semi-fixed, or portable protection system designed in conformance with good engineering practice such as those described in NFPA 11, *Standard for Low-, Medium-, and High-Expansion Foam*, NFPA 15, *Standard for Water Spray Fixed Systems for Fire Protection*, and NFPA 69, *Standard on Explosion Prevention Systems*. Ordinary combustibles (such as wood) would be subject to radiant heat unpiloted ignition from a burning tank, when such exposures are located a distance of less than about 150 percent of the tank diameter (assuming no wind effects). Exposure from adjacent property to the tanks would depend on the specific products and storage arrangement and may require some engineering analysis based on the occupancy and its exposure potential.

**A.22.11** "Accidental release" includes, but is not limited to, the following:

- (1) Leakage from the tank shell
- (2) Overfill
- (3) Leakage from piping connected to the tank

**A.22.11.2.2** An aboveground storage tank dike is normally sized to contain the entire contents of the largest single tank within it. Some designs incorporate sufficient freeboard (additional capacity) to accommodate precipitation or fire-fighting water. The amount of this freeboard is usually governed by local conditions.

**A.22.11.2.4.1** Diked areas for tanks containing Class I liquids located in extremely porous soils might require special treatment to prevent seepage of hazardous quantities of liquids to low-lying areas or waterways in case of spills.

**A.22.11.2.6.3.4** Because unstable liquids will react more rapidly when heated than when at ambient temperatures, subdivision by drainage channels is the preferred method.

**A.22.11.3.1** See A.22.11.2.2.

**A.22.12.1** As noted in the exception, engineering designs that can reduce exposure hazards include use of sealed sleeve piping and secondary containment piping to prevent leakage and the use of remotely controlled isolation valves on product lines to stop the flow of liquids when the piping is subjected to fire exposure.

**A.22.12.3** Methods of preventing an exposure hazard include intermediate diking, drainage, or fire protection features such as water spray systems, monitors, or fire-resistive coatings. High integrity pumps or equipment also constitute a method of limiting exposure hazards.

**A.22.17.4** An explosion hazard can exist due to flammable liquids or vapors within the pontoon. Ignition can be caused by lightning strikes or general maintenance activities. Lightning protection systems and other means of tank grounding cannot prevent sparking caused by lightning across gaps such as those between pontoon covers and the tank roof, between the tank wall and the roof, or at shunts. Such sparks can serve as a source of ignition causing a fire or explosion that can result in sufficient overpressure to throw portions of the pontoon assembly completely away from the tank with subsequent, partial, or complete loss of the tank due to fire. Caution is particularly advisable where tanks with vapor-containing pontoons are located within lightning-prone areas.

**A.23.3.4** Dropping or rolling the tank into the hole can break a weld, puncture or damage the tank, or scrape off the protective coating of coated tanks. See PEI RP100, *Recommended Practices for Installation of Underground Liquid Storage Systems*.

**A.23.3.5** See UL 1316, *Standard for Glass-Fiber-Reinforced Plastic Underground Storage Tanks for Petroleum Products, Alcohols, and Alcohol-Gasoline Mixtures*; UL 1746, *Standard for External Corrosion Protection Systems for Steel Underground Storage Tanks*; and STI ACT-100, *Specification for External Corrosion Protection of FRP Composite Steel Underground Tanks*, F894.

**A.23.3.5.1** See API RP 1615, *Installation of Underground Petroleum Storage Systems*, for further information.

**A.23.3.5.2** Acceptable design standards for cathodic protection systems include the following:

- (1) API RP 1632, *Cathodic Protection of Underground Petroleum Storage Tanks and Piping Systems*
- (2) CAN/ULC-S603.1, *Standard for External Corrosion Protection Systems for Steel Underground Tanks for Flammable and Combustible Liquids*
- (3) STI-P3, *Specification and Manual for External Corrosion Protection of Underground Steel Storage Tanks*
- (4) NACE RP-0169, *Recommended Practice, Control of External Corrosion on Underground or Submerged Metallic Piping Systems*
- (5) NACE RP-0285, *Recommended Practice, Corrosion Control of Underground Storage Tank Systems by Cathodic Protection*
- (6) ANSI/UL 1746, *Standard for External Corrosion Protection Systems for Steel Underground Storage Tanks, Part 1*
- (7) STI RP 892, *Recommended Practice for Corrosion Protection of Underground Piping Networks Associated with Liquid Storage and Dispensing Systems*

**A.23.5.3.1** Maximum burial depths, measured from the top of the tank, are established by the tank manufacturers and by independent testing laboratories.

**A.23.6.1** The required venting capacity depends upon the filling or withdrawal rate, whichever is greater, and the vent line length. Unrestricted vent piping sized in accordance with Table 23.6.2 will prevent back pressure development in tanks from exceeding a gauge pressure of 2.5 psi (17.2 kPa).

**A.23.14.1** Anchoring can be accomplished using nonmetallic straps or metallic straps that are separated from the tank shell by inert insulating dielectric material. The straps should be connected to a bottom hold-down pad or deadman anchors. For additional information, see reference to API RP 1615, *Installation of Underground Petroleum Storage Systems*; PEI RP100, *Recommended Practices for Installation of Underground Liquid Storage Systems*; and STI RP R011, *Recommended Practice for Anchoring of Steel Underground Storage Tanks*.

Previous editions of NFPA 30 included provisions for the use of water ballast as a means to weight a tank to prevent movement during a flood. In anticipation of a flood event, water could be used to fill the tank to reduce buoyancy. While this approach remains technically viable for existing tanks that are not properly secured to prevent movement, the use of water as a means of providing ballast is no longer considered an acceptable basis of design for new tank installations.

It is not the intent of this section to prohibit the use of water as ballast in underground tanks during system installation and prior to the initial introduction of the stored liquid.

**A.24.1** Chapter 24 provides an approach that allows considerable flexibility for compliance without compromising fire safety, while fostering ingenuity in application of fire safety principles to achieve the intended objectives, outlined in the performance criteria set out at the beginning of each subsection. Each subsection has been written with the first sentence outlining the performance criteria that, if implemented, would achieve compliance with that subsection. In order to clarify the intent of each performance criterion, the subsequent paragraphs constitute one method of achieving compliance with the intent envisioned in the performance requirements. It is recognized that other combinations of requirements can also be used to meet the intent of the performance criteria, provided such requirements are acceptable to the authority having jurisdiction.

**A.24.4.5(3)** See NFPA 68, *Standard on Explosion Protection by Deflagration Venting*, for information on deflagration venting.

**A.24.5.2** See NFPA 220, *Standard on Types of Building Construction*.

**A.24.5.4** See NFPA 68, *Standard on Explosion Protection by Deflagration Venting*, for information on deflagration venting.

**A.24.5.6** The purpose of the access aisles is to provide for ease of maintenance and emergency operations.

**A.24.6.1.1** NFPA 10, *Standard for Portable Fire Extinguishers*, provides information on the suitability of various types of extinguishers.

**A.24.6.1.2** See NFPA 13, *Standard for the Installation of Sprinkler Systems*, and NFPA 14, *Standard for the Installation of Standpipe and Hose Systems*.

**A.24.6.2.2** See NFPA 24, *Standard for the Installation of Private Fire Service Mains and Their Appurtenances*, for information on this subject.



**A.24.6.2.3** See NFPA 13, *Standard for the Installation of Sprinkler Systems*; NFPA 15, *Standard for Water Spray Fixed Systems for Fire Protection*; and NFPA 16, *Standard for the Installation of Foam-Water Sprinkler and Foam-Water Spray Systems*, for information on these subjects.

For certain fuel types, such as ketones, esters, and alcohols, the minimum required densities established in the listing criteria for foam discharge devices are often higher than the general densities specified for protection of flammable and combustible liquids. When determining the design criteria for extinguishing systems using foam, it is important to ensure that the listing criteria, which are typically based on empirical data from fire tests, are not overlooked. Otherwise, the fire protection system design can be inadequate for proper protection.

**A.24.9.6** Annex A of NFPA 15, *Standard for Water Spray Fixed Systems for Fire Protection*, provides information on this subject.

**A.24.10.2** Equipment in enclosed storage areas can deteriorate over time and periodic evaluation should be conducted to assure that leakage rates have not increased or that the ventilation rate is adequate for any increase in leakage rates.

**A.24.10.4** Local or spot ventilation might be needed for the control of special fire or health hazards. NFPA 91, *Standard for Exhaust Systems for Air Conveying of Vapors, Gases, Mists, and Non-combustible Particulate Solids*, and NFPA 90A, *Standard for the Installation of Air-Conditioning and Ventilating Systems*, provide information on this subject.

**A.24.14.6** Substitutes for manual gauging include, but are not limited to, heavy-duty flat gauge glasses; magnetic, hydraulic, or hydrostatic remote reading devices; and sealed float gauges.

**A.24.14.8** Suitable devices include, but are not limited to, a float valve; a pre-set meter on the fill line; a low head pump incapable of producing overflow; or a liquidtight overflow pipe, sized at least one pipe size larger than the fill pipe, that discharges by gravity back to the outside source of liquid or to an approved location.

**A.25.3.1** Inspections are recommended for shop-fabricated aboveground tanks. One guide is SP001, *Standard for Inspection of Aboveground Storage Tanks*, which is published by the Steel Tank Institute. In addition, the tank owner may desire to conduct additional inspections to ensure the ongoing integrity of tanks and equipment. Because the interior of a vault will ordinarily remain dry and temperature-moderated, environmental effects on tanks and equipment inside vaults will be reduced as compared to aboveground tanks that are not protected from weather exposure. Accordingly, inspection and maintenance frequencies for exterior surfaces of tanks and piping in vaults are typically less critical than for aboveground tanks installed outdoors. Nevertheless, inspection and maintenance of emergency vents and overflow prevention devices are still necessary.

Clearance between the shell of a tank or equipment in a vault and the interior vault wall should be sufficient to accommodate visual inspections and maintenance that may be needed. In addition, consideration should be given to the need for inspection and maintenance of tank interior surfaces that may be impacted by internal corrosion.

Clearance should be adequate to permit the following:

- (1) Entry into the vault interior by an inspector or maintenance worker

- (2) Access to manipulate, repair, or replace any equipment or fittings in the vault
- (3) Access within the vault to visually inspect, either by direct sight or with the aid of an optical vision extension tools, interior vault surfaces and exterior surfaces of tanks and equipment, to determine the source of any leakage that may occur, and to conduct any needed repairs

Because vaults are designed to provide for entry by inspectors or maintenance workers, consideration should also be given to providing access for rescue by emergency responders who may be called upon to rescue an individual from a vault. Such consideration may include providing a minimum access hatch dimension of 36 in. (915 mm) and a minimum dimension for walkways in vault interior spaces of 30 in. (760 mm) to permit an emergency responder with an SCBA to maneuver and providing, in some cases, a second means of access to the vault interior.

**A.25.5** Some of the specifications for vault design and construction include the following:

- (1) The walls and floor of the vault are to be constructed of reinforced concrete at least 6 in. (50 mm) thick.
- (2) The top and floor of the vault and the tank foundation must be designed to withstand all anticipated loading, including loading from vehicular traffic, where applicable.
- (3) The walls and floor of a belowgrade vault must be designed to withstand anticipated soil and hydrostatic loading.
- (4) The vault must be liquidtight.
- (5) The vault enclosure must have no openings except those necessary for access to, inspection of, and filling, emptying, and venting of the tank.
- (6) The vault must be provided with connections to permit ventilation to dilute, disperse, and remove any vapors prior to personnel entering the vault.
- (7) The vault must be provided with a means for personnel entry.
- (8) The vault must be provided with an approved means to admit a fire suppression agent.

**A.27.4.3.2** For further information, see ASTM E119, *Standard Test Methods for Fire Tests of Building Construction and Materials*, ANSI/UL 263, *Standard for Fire Tests of Building Construction and Materials*, and ANSI/UL 1709, *Standard for Rapid Rise Fire Tests of Protection Materials for Structural Steel*.

**A.27.5.1.2** It is expected that some joints may leak under fire conditions but will not come apart.

**A.27.6.2** API 2218, *Fireproofing Practices in Petroleum and Petrochemical Processing Plants*, contains guidance on selecting and installing fire-resistant coatings to protect exposed steel supports from a high-challenge fire exposure. It also contains a general discussion on determining need for such protection and estimating the extent of the area exposed.

**A.27.6.4** Buried steel piping should be coated with a suitable material and should be cathodically protected. Galvanized steel pipe, by itself and without other corrosion protection methods, is not acceptable for underground piping. Steel swing joints and stainless steel flexible connectors should also be made corrosion resistant when in contact with the soil. Thus, such fittings should also be coated and cathodically protected when installed between nonmetallic, compatible tanks and piping, such as fiberglass-reinforced plastic.

**A.27.8.1.6** Vent sizing formulas and prescriptive vent sizes, such as those established by ANSI/UL 142, *Standard for Steel*



*Aboveground Tanks for Flammable and Combustible Liquids*, are typically based on the direct installation of a venting device onto a tank. When the outlet of a vent must be extended to a remote location, such as for tanks located in buildings, which require vent discharges, to be located outside, a significant reduction in vent flow can occur unless the size of the vent and connecting piping is increased. In such cases, the size of vents and vent pipe extensions should be calculated to ensure that a tank will not be overpressurized during a fire exposure.

**A.27.8.2.1** API RP 500, *Recommended Practice for Classification of Locations for Electrical Installations at Petroleum Facilities Classified as Class I, Division 1 and Division 2*, and API RP 505, *Recommended Practice for Classification of Locations for Electrical Installations at Petroleum Facilities Classified as Class I, Zone 0, Zone 1, and Zone 2*, establish a 10 ft (3 m) classified zone around most tank vents that are potential sources of ignitable vapors. However, neither document provides specific distances for a belowgrade tank. Applying these strategies to 27.8.2.1 resulted in a minimum height for these tank vents of 10 ft (3 m) above grade. Since the majority of these vents exist at retail service station tanks, and since vehicles and other publicly introduced ignition sources could be located close to the vent, an additional 2 ft (0.6 m) was added to the minimum height as a safety factor to ensure the vehicle does not introduce a potential ignition source into the vapor space surrounding the vent. This results in a total height for the vent stack from a belowgrade tank of 12 ft (3.6 m).

**A.27.10** Where loading and unloading risers for Class II or Class IIIA liquids are located in the same immediate area as loading and unloading risers for Class I liquids, consideration should be given to providing positive means, such as different pipe sizes, connection devices, special locks, or other methods designed to prevent the erroneous transfer of Class I liquids into or from any container or tank used for Class II or Class IIIA liquids. Note that such consideration might not be necessary for water-miscible liquids, where the class is determined by the concentration of liquid in water, or where the equipment is cleaned between transfers.

**A.28.3.1.2** The use of nonconductive materials in the fill pipe assembly should be avoided to prevent any electrical discontinuity in the piping of the system. Serious accidents have occurred when nonconductive materials, such as plastic or rubber hose, have been used in the fill pipe assembly.

**A.28.4.2** Use of fixed fire protection systems, dikes, fire-rated barriers, or a combination of any of these can provide suitable protection from exposures.

**A.28.9** The intent of this requirement is to prevent the spread of uncontrolled, spilled liquid from traveling beyond the loading or unloading area and exposing surrounding equipment and buildings.

**A.28.11.1.5** NFPA 77, *Recommended Practice on Static Electricity*, provides additional information on static electricity protection.

**A.28.11.2.2** NFPA 77, *Recommended Practice on Static Electricity*, provides additional information on static electricity protection.

**A.28.11.3** The term *switch loading* describes a situation that warrants special consideration.

When a tank is emptied of a cargo of Class I liquid, a mixture of vapor and air is left, which can be, and often is, within the flammable range. When such a tank is refilled with a Class I liquid, any charge that reaches the tank shell will be bled off

by the required bond wire. Also, there will be no flammable mixture at the surface of the rising oil level because the Class I liquid produces at its surface a mixture too rich to be ignitable. This is the situation commonly existing in tank vehicles in gasoline service. If, as occasionally happens, a static charge does accumulate on the surface sufficient to produce a spark, it occurs in a too-rich, nonignitable atmosphere and thus causes no harm.

A very different situation arises if the liquid is “switch loaded,” that is, when a Class II or Class III liquid is loaded into a tank vehicle that previously contained a Class I liquid.

Class II or Class III liquids are not necessarily more potent static generators than the Class I liquid previously loaded, but the atmosphere in contact with the rising oil surface is not enriched to bring it out of the flammable range. If circumstances are such that a spark should occur either across the oil surface or from the oil surface to some other object, the spark occurs in a mixture that can be within the flammable range, and an explosion can result.

It is emphasized that bonding the tank to the fill stem is not sufficient; a majority of the recorded explosions have occurred when it was believed the tank had been adequately bonded. The electrostatic potential that is responsible for the spark exists inside the tank on the surface of the liquid and cannot be removed by bonding. Measures to reduce the change of such internal static ignition can be one or more of the following:

- (1) Avoid spark promoters. Conductive objects floating on the oil surface increase the charge of sparking to the tank wall. Metal gauge rods or other objects projecting into the vapor space can create a spark gap as the rising liquid level approaches the projection. A common precaution is to require that fill pipes (downspouts) reach as close to the bottom of the tank as practicable. Any operation such as sampling, taking oil temperature, or gauging that involves lowering a conductive object through an opening into the vapor space on the oil should be deferred until at least 1 minute after flow has ceased. This will permit any surface charge to relax.
- (2) Reduce the static generation by one or more of the following:
  - (a) Avoid splash filling and upward spraying of oil where bottom filling is used.
  - (b) Employ reduced fill rates at the start of filling through downspouts, until the end of the spout is submerged. Some consider 3 ft/sec (0.9 m/sec) to be a suitable precaution.
  - (c) Where filters are employed, provide relaxation time in the piping downstream from the filters. A relaxation time of 30 seconds is considered by some to be a suitable precaution.
- (3) Eliminate the flammable mixture before switch loadings by gas freeing or inerting.

See NFPA 77, *Recommended Practice on Static Electricity*, and NFPA 385, *Standard for Tank Vehicles for Flammable and Combustible Liquids*, for further information.

**A.28.11.4.1** Emergency and safety procedures include, but are not limited to, the following:

- (1) Procedures for bonding and grounding the tank vehicle
- (2) Proper use of portable extinguishers
- (3) Procedures for recognizing and eliminating sources of ignition



**Table A.29.3.28 Typical Fire Protection for Wharves and Marine Terminals**

Locations	Water Demand (gpm)	Hydrant Monitors <sup>a</sup> (gpm)	Hose Reels	Fire Extinguisher Dry Chemical		International Shore Connection	Emergency Equipment Lockers	Monitors and Hose Foam Concentrate Required (gal)	Fire Boat Connection
				30 lb	150 lb Wheeled				
Barge terminals	500–1000	Two 500	Two 1¼	2	NR	NR	1	100 <sup>b</sup>	NR
Tankers 20,000 DWT and under	1000–2000	Two 500	Two 1¼	2	1	1	1	300 <sup>b</sup>	2
20,001–70,000 DWT	2000	Two 1000	Four 1¼ <sup>c</sup>	2	2 <sup>d</sup>	2	1	2000	2
70,001 DWT and over	2000 <sup>e</sup>	Two 1000	Four 1¼ <sup>c</sup>	3	2 <sup>d</sup>	2	1	2000 <sup>f</sup>	2
Sea islands	2000–4000 <sup>e</sup>	Three 1000	Four 1¼ <sup>c</sup>	4	2	3	2	3000	2

For SI units, 1 gpm = 3.8 L/min; 1 gal = 3.8 L; 1 lb = 0.45 kg.

NR: Not required.

<sup>a</sup>A minimum of two 1½ in. (38 mm) hydrant outlets should be provided at each monitor riser.

<sup>b</sup>Can be provided by onshore mobile equipment.

<sup>c</sup>One hose reel at each berth should have foam capability.

<sup>d</sup>The proximity of adjacent berths can reduce total required.

<sup>e</sup>Under-dock systems are optional. Add water for under-dock system (0.16 × area).

<sup>f</sup>Under-dock systems are optional. Add foam for under-dock system (0.16 × 0.3 × 30 × area).

- (4) Procedures for recognizing and understanding contingency plans for handling a spill or leak
- (5) Procedures for notifying the appropriate agencies in an emergency

**A.29.3.25** Where practical, the collection basin should be drained to a remote location.

**A.29.3.28** Because of the many variables involved, exact requirements cannot be provided. However, Table A.29.3.28 provides guidance on the level of fire protection typically provided at wharves and marine terminals handling flammable liquids.

## Annex B Emergency Relief Venting for Fire Exposure for Aboveground Tanks

*This annex is not a part of the requirements of this NFPA document but is included for informational purposes only.*

**B.1 General.** The requirements for emergency venting given in Table 22.7.3.2 and the modification factors in 22.7.3.5 are derived from a consideration of the following:

- (1) Probable maximum rate of heat transfer per unit area
- (2) Size of tank and the percentage of total area likely to be exposed
- (3) Time required to bring tank contents to boil
- (4) Time required to heat unwet portions of the tank shell or roof to a temperature where the metal will lose strength
- (5) Effect of drainage, insulation, and the application of water in reducing fire exposure and heat transfer

**B.2 Derivation of Table 22.7.3.2.** Table 22.7.3.2 is based on a composite curve (see Figure B.2) that is composed of three straight lines when plotted on log-log graph paper. The curve can be defined in the following manner:

- (1) The first straight line is drawn between the points 400,000 Btu/hr at 20 ft<sup>2</sup> (1.86 m<sup>2</sup>) exposed surface area, and 4,000,000 Btu/hr at 200 ft<sup>2</sup> (18.6 m<sup>2</sup>) exposed surface area. The equation for this portion of the curve is the following:

$$Q = 20,000A \quad [\text{B.2(a)}]$$

where:

$Q$  = Btu/hr

$A$  = exposed shell area (ft<sup>2</sup>)

- (2) The second straight line is drawn between the points 4,000,000 Btu/hr at 200 ft<sup>2</sup> (18.6 m<sup>2</sup>) exposed surface area, and 9,950,000 Btu/hr at 1000 ft<sup>2</sup> (93 m<sup>2</sup>) exposed surface area. The equation for this portion of the curve is the following:

$$Q = 199,300(A)^{0.566} \quad [\text{B.2(b)}]$$

where:

$Q$  = Btu/hr

$A$  = exposed shell area (ft<sup>2</sup>)

- (3) The third straight line is drawn between the points 9,950,000 Btu/hr at 1000 ft<sup>2</sup> (93 m<sup>2</sup>) exposed surface area, and 14,090,000 Btu/hr at 2800 ft<sup>2</sup> (260 m<sup>2</sup>) exposed surface area. The equation for this portion of the curve is the following:

$$Q = 963,400(A)^{0.338} \quad [\text{B.2(c)}]$$

where:

$Q$  = Btu/hr

$A$  = exposed shell area (ft<sup>2</sup>)

The data for plotting the three lines are given in Table B.2.

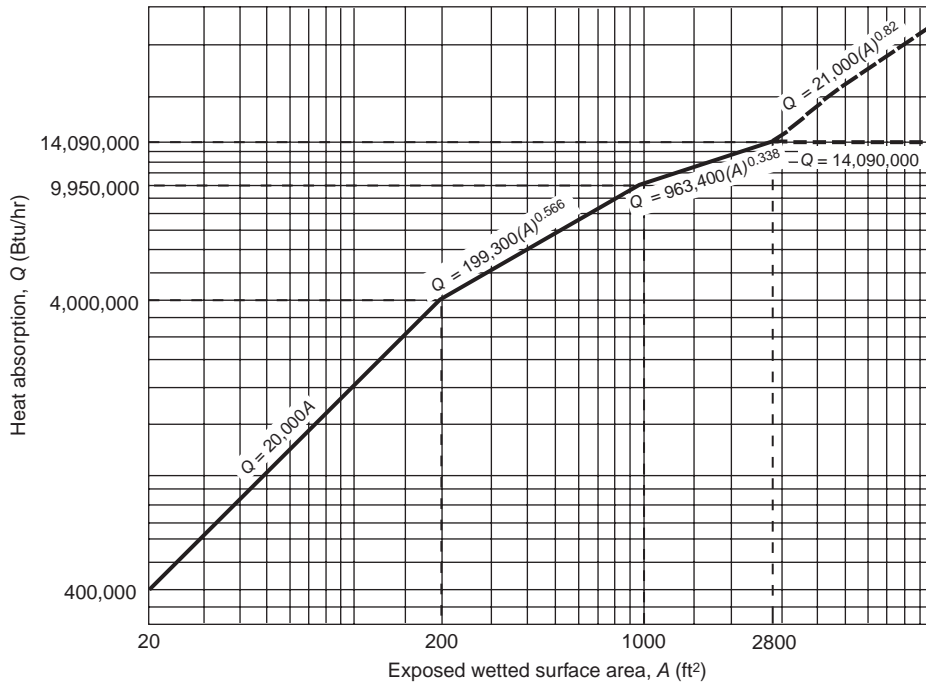

- Notes: (1) For SI units, 1 ft<sup>2</sup> = 0.09 m<sup>2</sup>.
- (2) See Table B.4 for approximate wetted area for horizontal tanks.

**FIGURE B.2 Curve for Determining Requirements for Emergency Venting During Fire Exposure.**

**Table B.2 Data for Figure B.2**

$Q = 20,000A$		$Q = 199,300(A)^{0.566}$		$Q = 963,400(A)^{0.338}$	
A	Q	A	Q	A	Q
20	400,000	200	4,000,000	1000	10,000,000
30	600,000	250	4,539,000	1200	10,593,000
40	800,000	300	5,032,000	1400	11,122,000
50	1,000,000	350	5,491,000	1600	11,601,000
60	1,200,000	400	5,922,000	1800	12,040,000
70	1,400,000	500	6,719,000	2000	12,449,000
80	1,600,000	600	7,450,000	2400	13,188,000
90	1,800,000	700	8,129,000	2800	14,000,000
100	2,000,000	800	8,768,000	and over	
120	2,400,000	900	9,372,000		
140	2,800,000	1000	10,000,000		
160	3,200,000				
180	3,600,000				
200	4,000,000				

For SI units, 1 ft<sup>2</sup> = 0.093 m<sup>2</sup>; 1 Btu/hr = 0.293 × 10<sup>-4</sup> kW.

**B.2.1** For areas exceeding 2800 ft<sup>2</sup> (260 m<sup>2</sup>), it has been concluded that complete fire involvement is unlikely, and loss of metal strength from overheating will cause failure in the vapor space before development of maximum possible vapor evolution rate. Therefore, additional venting capacity beyond the vapor equivalent of 14,000,000 Btu/hr (4100 kW) shown in Table B.2 will not be effective or required.

**B.2.2** For tanks and storage vessels designed for pressures over a gauge pressure of 1.0 psi (6.9 kPa), additional venting for exposed surfaces beyond 2800 ft<sup>2</sup> (260 m<sup>2</sup>) is believed to be desirable because, under these storage conditions, liquids are stored close to their boiling points. Therefore, the time to bring the container contents to boiling conditions is not necessarily significant. For these situations, a heat input value should be determined on the basis of the following equation:

$$Q = 21,000(A)^{0.82} \quad [B.2.2]$$

where:  
 Q = Btu/hr  
 A = exposed shell area (ft<sup>2</sup>)

**B.3 Estimation of Emergency Relief Venting for Specific Liquids.** The flow capacities estimated in Section B.2 are based on the assumption that the stored liquid will have the characteristics of hexane and the vapor liberated has been transposed to equivalent free air at 60°F (15.6°C) and an absolute pressure of 14.7 psi (101.3 kPa), by using appropriate factors in the following equation:

$$CFH = \frac{70.5Q}{L\sqrt{M}} \quad [B.3]$$

where:  
 CFH = cubic feet of free air per hour  
 70.5 = factor for converting pounds of gas to ft<sup>3</sup> of air  
 Q = total heat input per hour (Btu)  
 L = latent heat of vaporization (Btu/lb)  
 M = molecular weight

No consideration has been given to possible expansion from the heating of the vapor above the boiling point of the liquid, its specific heat, or the difference in density between the discharge temperature and 60°F (15.6°C), because some of these changes are compensating.

Because tank vent valves are ordinarily rated in CFH standard air, the figures derived from Table 22.7.3.2 can be used with the appropriate tank pressure as a basis for valve selection.

Table B.3 gives constants that can be used to compute the vapor generated and equivalent free air for liquids other than hexane, where greater exactness is desired. Inspections of the table will show that the use of hexane in deriving Table 22.7.3.2 provides results that are within an acceptable degree of accuracy for the listed liquids.

**Table B.3 Values of  $L\sqrt{M}$  for Various Liquids**

Chemical	$L\sqrt{M}$	Molecular Weight	Heat of Vaporization (Btu/lb) at Boiling Point
Acetaldehyde	1673	44.05	252
Acetic acid	1350	60.05	174
Acetic anhydride	1792	102.09	177
Acetone	1708	58.08	224
Acetonitrile	2000	41.05	312
Acrylonitrile	1930	53.06	265
n-Amyl alcohol	2025	88.15	216
iso-Amyl alcohol	1990	88.15	212
Aniline	1795	93.12	186
Benzene	1493	78.11	169
n-Butyl acetate	1432	116.16	133
n-Butyl alcohol	2185	74.12	254
iso-Butyl alcohol	2135	74.12	248
Carbon disulfide	1310	76.14	150
Chlorobenzene	1422	112.56	134
Cyclohexane	1414	84.16	154
Cyclohexanol	1953	100.16	195
Cyclohexanone	1625	98.14	164
o-Dichlorobenzene	1455	147.01	120
cis-Dichloroethylene	1350	96.95	137
Diethylamine	1403	73.14	164
Dimethylacetamide	1997	87.12	214
Dimethylamine	1676	45.08	250
Dimethylformamide	2120	73.09	248
Dioxane (diethylene ether)	1665	88.10	177
Ethyl acetate	1477	88.10	157
Ethyl alcohol	2500	46.07	368
Ethyl chloride	1340	64.52	167
Ethylene dichloride	1363	98.96	137
Ethyl ether	1310	74.12	152
Furan	1362	68.07	165
Furfural	1962	96.08	200
Gasoline	1370-1470	96.0	140-150
n-Heptane	1383	100.20	138
n-Hexane	1337	86.17	144
Hydrogen cyanide	2290	27.03	430
Methyl alcohol	2680	32.04	474
Methyl ethyl ketone	1623	72.10	191
Methyl methacrylate	1432	100.14	143
n-Octane	1412	114.22	132
n-Pentane	1300	72.15	153
n-Propyl acetate	1468	102.13	145
n-Propyl alcohol	2295	60.09	296
iso-Propyl alcohol	2225	60.09	287
Tetrahydrofuran	1428	72.10	168
Toluene	1500	92.13	156
Vinyl acetate	1532	86.09	165
o-Xylene	1538	106.16	149

For SI units, 1 Btu/lb = 2.3 kJ/kg.

Note: For data on other chemicals, refer to available handbooks on properties of chemicals.

**B.4 Estimation of Wetted Area for Horizontal Tanks.**  
Table B.4 gives the approximate wetted area for various sizes

and configurations of horizontal tanks with flat heads, based on 75 percent of total shell area.

**Table B.4 Approximate Wetted Areas for Horizontal Tanks with Flat Heads**

Tank Length (ft)	Tank Diameter (ft)									
	3	4	5	6	7	8	9	10	11	12
3	32	—	—	—	—	—	—	—	—	—
4	39	55	—	—	—	—	—	—	—	—
5	46	65	88	—	—	—	—	—	—	—
6	53	74	100	128	—	—	—	—	—	—
7	60	84	112	142	173	—	—	—	—	—
8	67	93	124	156	190	226	—	—	—	—
9	74	102	136	170	206	245	286	—	—	—
10	81	112	147	184	223	264	308	353	—	—
11	88	121	159	198	239	283	329	377	428	—
12	95	131	171	213	256	301	350	400	454	509
13	102	140	183	227	272	320	371	424	480	537
14	109	150	194	241	289	339	393	447	506	565
15	116	159	206	255	305	358	414	471	532	594
16	123	169	218	269	322	377	435	495	558	622
17	130	178	230	283	338	395	456	518	584	650
18	137	188	242	298	355	414	477	542	610	678
19	—	197	253	312	371	433	499	565	636	707
20	—	206	265	326	388	452	520	589	662	735
21	—	216	277	340	404	471	541	612	688	763
22	—	225	289	354	421	490	562	636	714	792
23	—	235	300	368	437	508	584	659	740	820
24	—	244	312	383	454	527	605	683	765	848
25	—	—	324	397	470	546	626	706	791	876
26	—	—	336	411	487	565	647	730	817	905
27	—	—	347	425	503	584	668	754	843	933
28	—	—	359	440	520	603	690	777	869	961
29	—	—	371	454	536	621	711	801	895	989
30	—	—	383	468	553	640	732	824	921	1018
31	—	—	395	482	569	659	753	848	947	1046
32	—	—	—	496	586	678	775	871	973	1074
33	—	—	—	510	602	697	796	895	999	1103
34	—	—	—	524	619	715	817	918	1025	1131
35	—	—	—	539	635	734	838	942	1051	1159
36	—	—	—	553	652	753	860	966	1077	1187
37	—	—	—	567	668	772	881	989	1103	1216
38	—	—	—	—	685	791	902	1013	1129	1244
39	—	—	—	—	701	810	923	1036	1155	1272
40	—	—	—	—	718	828	944	1060	1181	1301
41	—	—	—	—	734	847	966	1083	1207	1329
42	—	—	—	—	751	866	987	1107	1233	1357
43	—	—	—	—	767	885	1008	1130	1259	1385
44	—	—	—	—	—	904	1029	1154	1284	1414
45	—	—	—	—	—	923	1051	1178	1310	1442
46	—	—	—	—	—	941	1072	1201	1336	1470
47	—	—	—	—	—	960	1093	1225	1362	1498
48	—	—	—	—	—	979	1114	1248	1388	1527
49	—	—	—	—	—	998	1135	1272	1414	1555
50	—	—	—	—	—	—	1157	1295	1440	1583
51	—	—	—	—	—	—	1178	1319	1466	1612
52	—	—	—	—	—	—	1199	1342	1492	1640
53	—	—	—	—	—	—	1220	1366	1518	1668
54	—	—	—	—	—	—	1246	1389	1544	1696
55	—	—	—	—	—	—	1263	1413	1570	1725
56	—	—	—	—	—	—	—	1437	1593	1753
57	—	—	—	—	—	—	—	1460	1622	1781

Table B.4 *Continued*

Tank Length (ft)	Tank Diameter (ft)									
	3	4	5	6	7	8	9	10	11	12
58	—	—	—	—	—	—	—	1484	1648	1809
59	—	—	—	—	—	—	—	1507	1674	1839
60	—	—	—	—	—	—	—	1531	1700	1866
61	—	—	—	—	—	—	—	—	1726	1894
62	—	—	—	—	—	—	—	—	1752	1923
63	—	—	—	—	—	—	—	—	1778	1951
64	—	—	—	—	—	—	—	—	1803	1979
65	—	—	—	—	—	—	—	—	1829	2007
66	—	—	—	—	—	—	—	—	1855	2036
67	—	—	—	—	—	—	—	—	—	2064
68	—	—	—	—	—	—	—	—	—	2092
69	—	—	—	—	—	—	—	—	—	2120
70	—	—	—	—	—	—	—	—	—	2149
71	—	—	—	—	—	—	—	—	—	2177
72	—	—	—	—	—	—	—	—	—	2205

For SI units, 1 ft = 0.3 m; 1 ft<sup>2</sup> = 0.09 m<sup>2</sup>.

### Annex C Temporarily Out of Service, Closure in Place, or Closure by Removal of Underground Storage Tanks

*This annex is not a part of the requirements of this NFPA document but is included for informational purposes only.*

#### C.1 General.

**C.1.1** Care is required not only in the handling and use of flammable or combustible liquids but also in the process of rendering temporarily out of service, closing, or removing tanks that have held flammable or combustible liquids. This is particularly true of underground service station tanks that are most frequently used for the storage of motor fuel and occasionally for the storage of other flammable or combustible liquids, such as crankcase drainings, which can contain some gasoline. Through carelessness, explosions have occurred because flammable or combustible liquid tanks have not been properly conditioned before being rendered temporarily out of service, closed, or removed.

**C.1.2** In order to prevent accidents caused by improper conditioning, it is recommended that the procedures outlined in this annex be followed when underground tanks are temporarily taken out of service, closed, or removed.

**C.1.3** Underground tanks taken out of service can be safeguarded or disposed of by any one of the following three means:

- (1) Placement in a temporarily out-of-service condition. Tanks should be rendered temporarily out of service only when it is planned that they will be returned to active service within a reasonable period or pending closure in place or closure by removal.
- (2) Permanent closure in place, with proper safeguarding.
- (3) Permanent closure by removal.

**C.1.4** In cases where tanks are either rendered temporarily out of service or permanently closed, records should be kept of tank size, location, date of closure, and method used for placing the closed tank in a safe condition.

**C.1.5** Procedures for carrying out each of the methods in C.1.3 of disposing of underground tanks are described in Section C.2 through Section C.6. No cutting torch or other flame- or spark-producing equipment should be used until the tank has been completely purged or otherwise rendered safe. In each case, the steps given should be carried out successively.

#### C.2 Rendering Underground Storage Tanks Temporarily Out of Service.

**C.2.1** When the underground storage tank system (UST) is temporarily out of service for less than 3 months, the owners and operators should comply with the following:

- (1) Continue operation and maintenance of corrosion protection. Requirements can be found in U.S. Environmental Protection Agency (EPA), 40 CFR 280.31, "Technical Standards and Requirements for Owners and Operators of Underground Storage Tanks."
- (2) Continue operation and maintenance of any release detection in accordance with U.S. EPA, 40 CFR 280, Subpart D, or empty the UST system by removing all materials so that no more than 1 in. (25 mm) of residue, or 0.3 percent by weight of the total capacity of the UST system, remains in the system.

**C.2.2** When a UST system is temporarily out of service for 3 months or more, owners and operators should also comply with the following requirements:

- (1) Leave vent lines open and functioning
- (2) Cap or plug all other lines such as fill line, gauge opening, pump suction, and ancillary equipment and secure against tampering

**C.3 Permanent Closure of Underground Storage Tanks.** When a UST system is temporarily closed for more than 12 months, owners and operators should permanently close the UST system in accordance with U.S. EPA, 40 CFR 280.71–280.74. An extension of this 12-month period can be granted by the implementing agency. However, before such an extension can be applied for, a site assessment should be completed in accordance with U.S. EPA, 40 CFR 280.72.

#### C.4 Closure in Place of Underground Storage Tanks.

**C.4.1** At least 30 days before beginning closure procedures, owners and operators should notify the implementing agency of their intent to close unless such action is in response to corrective action proceedings.

**C.4.2** Closure of tanks either in place or by removal requires the owners and operators to measure for the presence of a release where contamination is most likely to be present at the UST site. This requirement can be satisfied if one of the external release detection methods allowed in 40 CFR 280.43(e) and (f) is operating in accordance with the requirements in Part 280.43 at the time of closure and indicates no release has occurred.

**C.4.3** Prepare a safe workplace by following the special safety precautions and cleaning and closure procedures in either of the following documents:

- (1) API 1604, *Removal and Disposal of Used Underground Petroleum Storage Tanks*
- (2) NEIWPCC, *Tank Closure Without Tears: An Inspector's Safety Guide*

**C.4.4** Safe work preparation should include the following:

- (1) No smoking in the area.
- (2) Shutting down all open flame and spark-producing equipment not necessary for the removal of the underground tank.
- (3) Using only hand tools to expose tank fittings and preparing for the vapor-freeing procedures.
- (4) Controlling static electricity or providing a conductive path to discharge static electricity by bonding and grounding equipment and vehicles.
- (5) Roping off tank area from pedestrian and vehicular traffic.
- (6) Locating and marking all utility lines on site.
- (7) Determining meteorological conditions. Vapor accumulation can occur on still and high-humidity days. Under these conditions, test the area for vapor accumulation (*see C.4.10*), and if present, either provide additional forced ventilation or delay the job until there is a breeze and it is less humid. Excavated soil should be tested for vapor release. Artificial ventilation or repeated turning of excavated soil might be necessary to avoid ignitable concentration of vapors.
- (8) Ensuring that personnel are wearing hard hats, safety shoes, and safety glasses and that a combustible gas indicator is available. Providing any other safety measures or methods that might be required to meet local requirements.

**C.4.5** Remove all flammable or combustible liquid and residue from the tank and from all connecting lines.

**C.4.6** Residual product and solids should be disposed of properly.

**C.4.7** Excavate to the top of the tank.

**C.4.8** Disconnect the suction, inlet, gauge, and all other tank fixtures. The vent line should remain connected until the tank is purged.

**C.4.9** Either purge the tank of flammable vapors or inert the potentially explosive atmosphere in the tank.

**C.4.9.1** Purging or ventilating the tank replaces the flammable vapors in the tank with air, reducing the flammable

mixture of fuel and oxygen below the lower explosive limit or lower flammable limit (LFL). Two methods can be used to introduce air into the tank. One is the use of a "diffused-air blower" to pump air into the bottom of the tank through the fill pipe or a properly bonded air-diffusing pipe. The second method is the use of an "eductor-type air mover," typically driven by compressed air. It draws vapors out of the tank and brings fresh air into the tank. The vent pipe can be used to exhaust vapors 12 ft (3.7 m) above grade and 3 ft (0.9 m) from any roof lines.

**C.4.9.2** Inerting the tank does not replace the flammable vapors but instead reduces the concentration of oxygen to a level insufficient to support combustion (*see C.4.10*). Two inert gases can be used. Carbon dioxide gas can be generated by crushing and distributing dry ice evenly over the bottom of the tank. The dry ice will release carbon dioxide as it warms. Nitrogen gas can be pumped into the tank from a hose through the fill hole to the bottom of the tank. Oxygen will be reintroduced into the tank unless all holes are effectively plugged except for the vent line.

**C.4.10** The tank should be tested to determine if it is safe by one of the following procedures:

- (1) When purging, a combustible gas indicator is used to measure the reduction in the concentration of flammable vapors. The meter reads from 0 to 100 percent of the LFL. The goal is to achieve a reading of 10 to 20 percent LFL for petroleum tanks.
- (2) When inerting, an oxygen meter is used to determine when a tank has been successfully inerted. The meter reads from 0 to 100 percent oxygen content. The goal is to achieve a reading of 1 to 10 percent, which is safe for most petroleum products.

**C.4.11** Fill the tank completely with an inert solid material. One or more holes can be cut in the tank top if existing tank openings are not adequate for the introduction of the inert material. Cap or remove remaining underground piping. The tank can now be backfilled.

#### C.5 Permanent Removal of Underground Storage Tanks.

**C.5.1** Observe all procedures listed under Section C.4, except for C.4.11, filling the tank with an inert solid material and backfilling the excavation.

**C.5.2** After the tank has been made safe by following purging or inerting procedures and before it is removed from the excavation, plug or cap all accessible holes. One plug should have a 1/8 in. (3 mm) vent hole to prevent the tank from being subjected to excessive differential pressure caused by temperature changes. This vent should be positioned on top of the tank during subsequent transportation or storage.

**C.5.3** Excavate around the tank to uncover it for removal. Remove the tank from the excavation and check for corrosion holes in the tank shell. Use screwed boiler plugs to plug any corrosion holes.

**C.5.4** Tanks should be labeled with information about the former contents, present vapor state, vapor-freeing treatment method, and a warning against reuse.

**C.5.5** Tanks should be removed from the site promptly and preferably the same day as taken from the ground because additional vapor can be released from liquid absorbed in tank



wall corrosion or residues. However, before removal, the tank atmosphere must be checked to ensure the flammable vapor concentration does not exceed safe levels.

### C.6 Disposal of Underground Storage Tanks.

**C.6.1** If the reuse of a tank is permitted by the controlling jurisdiction, the tank should be certified that it is tight, structurally sound, and will meet all requirements of a new installation.

**C.6.2** The storage of used tanks should be in secure areas where the public will not have access. Tanks should be rendered safe consistent with C.4.9 and C.4.10 and vented consistent with C.5.2.

**C.6.3** If a steel tank is to be disposed of, it should be retested for flammable vapors and, if necessary, again rendered gas free. Tanks that have been lined internally or coated externally with fiberglass, epoxy-based, or similar materials might not be accepted by scrap processors. Before releasing to a scrap metal dealer, a sufficient number of holes or openings should be made in the tank to render it unfit for further use. NFPA 326, *Standard for the Safeguarding of Tanks and Containers for Entry, Cleaning, or Repair*, provides information on safe procedures for such operations.

**C.6.4** If the tank to be disposed of is nonmetallic or is a steel tank lined internally or coated externally with fiberglass, epoxy-based, or similar materials, it might not be accepted by scrap metal dealers. An alternative disposal method would be to cut up the tank in sections suitable for disposal in a sanitary landfill.

**C.7 Record Keeping.** Record keeping is required to demonstrate compliance with closure requirements under 40 CFR 280.74. The results of the excavation zone assessment required in Part 280.72 should be maintained for at least 3 years after completion of permanent closure.

**C.8 Resources.** Other resources to check for information related to safety during tank closure include the following:

- (1) API 1604, *Removal and Disposal of Used Underground Petroleum Storage Tanks*
- (2) API 1631, *Interior Lining of Underground Storage Tanks*
- (3) API 2015, *Cleaning Petroleum Storage Tanks*
- (4) API 2217A, *Guidelines for Work in Inert Confined Spaces in the Petroleum Industry*
- (5) API 2219, *Safe Operating Guidelines for Vacuum Trucks in Petroleum Service*
- (6) OSHA 2226, *Excavation and Trenching Operations*
- (7) NIOSH, *Criteria for Recommended Standard for Working in Confined Spaces*
- (8) NIOSH 87–113, *A Guide to Safety in Confined Spaces*
- (9) NFPA 69, *Standard on Explosion Prevention Systems* (table with minimum oxygen levels necessary to support combustion for various products)
- (10) NFPA 77, *Recommended Practice on Static Electricity*
- (11) NFPA 326, *Standard for the Safeguarding of Tanks and Containers for Entry, Cleaning, or Repair*
- (12) NFPA 306, *Standard for the Control of Gas Hazards on Vessels* (practical procedures for vapor-freeing tanks and testing guidance)
- (13) NEIWPCC, *Tank Closure Without Tears: An Inspector's Safety Guide*

## Annex D Development of Fire Protection System Design Criteria for Chapter 16 and Suggested Fire Protection for Some Containers of Flammable and Combustible Liquids Not Covered in Chapter 16

*This annex is not a part of the requirements of this NFPA document but is included for informational purposes only.*

**D.1 General.** The development of suppression-oriented protection criteria for liquids in containers relies almost exclusively on the evaluation of large-scale fire test data. Characterization of fire development, fire spread to adjacent containers/materials, suppression system activation, and suppression system effectiveness based on first principles is not well established. Reliance on actual test data for all situations and scenarios is not, however, practical from a cost standpoint. Development of NFPA 30 protection criteria, therefore, relies on data from representative test scenarios. Alternative materials and scenarios are then evaluated in terms of the specific test data, historical test data, and engineering experience with the hazards. Pending the complete development of engineering tools to evaluate hazards, this approach represents the best method to meet the NFPA policy that codes and standards be scientifically based.

**D.2 Summary of Fire Protection Design Criteria.** In developing the fire protection criteria set forth in Chapter 16, the NFPA 30 Container Protection Task Group evaluated numerous fire tests, 147 of which have been summarized in the *Directory of Fire Tests Involving Storage of Flammable and Combustible Liquids in Containers*, 3rd edition. This directory was authored by David P. Nugent, Schirmer Engineering Corporation, and is available by special arrangement with Schirmer Engineering Corporation from the Society of Fire Protection Engineers. Users of this code who wish to investigate details of the fire tests on which Chapter 16 is based are referred to this directory.

The summaries in Table D.2(a) through Table D.2(l) provide a brief justification statement for each entry in Table 16.5.2.1 through Table 16.5.2.12. Each entry in Table 16.5.2.1 through Table 16.5.2.12 includes a fire test reference number that appears in the last column of each table and is keyed to Table D.2(a), Table D.2(b), or Table D.2(c). The test numbers given in the justification statements refer to the tests reported in Nugent's directory. As noted, in some cases, the NFPA 30 Container Protection Task Group exercised some judgment in evaluating the test data in order to develop fire protection criteria for various combinations of class of liquid, container type and size, and storage arrangement.

**D.3 Recommended Fire Protection System Design Criteria for Class IA Liquids.** There are a number of commodities for which there were no or insufficient test data to develop definitive protection tables. One example is Class IA liquids. Table D.3(a) through Table D.3(c) contain the protection that was contained in Appendix D of the 1993 edition of NFPA 30 for Class IA liquids.

Additional useful information for evaluating fire risk can be found in the technical report, "A Fire Risk Analysis Model for Assessing Options for Flammable and Combustible Liquid Products in Storage and Retail Occupancies" by Dr. John R. Hall, Jr., NFPA.

**D.4 Recommended Fire Protection System Design Criteria for High Flash Point Class IIIB Liquids.** Table D.4(a) provides recommended sprinkler system design criteria for Class IIIB liquids having flash points greater than 450°F (230°C). Table D.4(b) provides cross-references to fire tests (summarized in the SFPE *Directory of Fire Tests Involving Storage of Flammable and Combustible Liquids in Small Containers*, 3rd edition), on which these recommendations are based.



**Table D.2(a) Summary of Fire Test References for Table 16.5.2.1**

Ref. No.	Technical Justification and Test Identifier in Directory
1	Results of Test S-42, with extrapolation of data to allow increase in maximum ceiling height from 27 ft (8.2 m) to 30 ft (9.1 m).
2	Results of Test S-40, with extrapolation of data to allow increase in maximum ceiling height from 27 ft (8.2 m) to 30 ft (9.1 m).
3	Results of Tests S-22 through S-44, with emphasis on Test S-40, in which no ceiling sprinklers operated. Test S-26 justifies increasing maximum container size from 1 gal (3.8 L) to 5 gal (19 L).
4	Extrapolation of data in Ref. No. 3. Reduced hazard of Class IIIB liquids justifies increase in allowable storage height and maximum ceiling height and decrease in required ceiling sprinkler design area.
5	Based on data in Ref. No. 3 above. Potential for larger spill justifies increase in ceiling sprinkler design density and disallowing quick-response sprinklers. In addition, Tests 572 through 576 indicate the need for face sprinklers at the first level at each rack upright to prevent collapse of the rack due to fire.
6	Results of Tests S-22 through S-44. Reduced hazard of Class IIIB liquids justifies increase in allowable storage height and maximum ceiling height and decrease in required ceiling sprinkler design density. Increased container size justifies increase in ceiling sprinkler design area compared to Ref. No. 4.
7	Results of Test S-31.
8	Results of Tests S-22 through S-44, with emphasis on Test S-40. Use of relieving-style container is expected to reduce potential for container rupture, but could contribute to rate of heat release during a fire.
9	Based on data in Ref. No. 4 and recognition that there is little advantage to use of relieving-style containers for Class IIIB liquids.
10	Results of Tests S-22 through S-46. See also Ref. No. 5. Increase in ceiling sprinkler design density justifies in-rack sprinklers at every other level, rather than at every level. In addition, Tests 572 through 576 indicate the need for face sprinklers at the first level at each rack upright to prevent collapse of the rack due to fire.
11	Based on data in Ref. No. 6 and recognition that there is little advantage to use of relieving-style containers for Class IIIB liquids.
12	Based on protection criteria recommended for portable tanks in Appendix D of 1993 edition of NFPA 30 and on results of Tests S-45 and S-46. In addition, Tests 572 through 576 indicate the need for face sprinklers at the first level at each rack upright to prevent collapse of the rack due to fire.
13	Based on protection criteria recommended for portable tanks in Appendix D of 1993 edition of NFPA 30 and data in Ref. No. 6 and recognition that there is little advantage to use of relieving-style containers for Class IIIB liquids.

**Table D.2(b) Summary of Fire Test References for Table 16.5.2.2**

Ref. No.	Technical Justification and Test Identifier in Directory
1	Results of Test S-15.
2	Results of Test S-5 and Tests S-13 through S-15, with particular emphasis on Test S-5.
3	Results of Test S-5 and Tests S-13 through S-18, with application of engineering judgment to Test S-13.
4	Results of Test S-5 and Tests S-19 through S-21. Larger container size justifies increased ceiling sprinkler design density over that specified in Ref. No. 2.
5	Results of Test S-5 and Tests S-13 through S-18 and protection criteria recommended in Appendix D, Table D-2.2 of 1993 edition of NFPA 30. Quick-response sprinklers are allowed based on experience in testing containers not greater than 19 L (5 gal) capacity.
6	Results of Test S-5 and Tests S-13 through S-21 and protection criteria recommended in Appendix D, Table D-2.2 of 1993 edition of NFPA 30.
7	Results of Test S-5 and Tests S-13 through S-21 and protection criteria recommended in Appendix D, Table D-2.2 of 1993 edition of NFPA 30.
8	Results of Test S-18, with consideration given to Tests S-16 and S-17.
9	Results of Test S-5 and Tests S-19 through S-21. Use of relieving-style containers justifies increase in maximum ceiling height.
10	Based on data in Ref. Nos. 4 and 9. Increased ceiling sprinkler design density allows storage two tiers high.
11	Based on data in Ref. No. 5 and recognition that there is little advantage to use of relieving-style containers for Class IIIB liquids.
12	Based on data in Ref. No. 6 and recognition that there is little advantage to use of relieving-style containers for Class IIIB liquids.
13	Based on data in Ref. No. 7 and recognition that there is little advantage to use of relieving-style containers for Class IIIB liquids.
14	Based on protection criteria recommended in Appendix D, Table D-2.2 of 1993 edition of NFPA 30, with consideration given to results of Tests S-19 through S-21.
15	Based on protection criteria recommended in Appendix D, Table D-2.2 of 1993 edition of NFPA 30, with consideration given to results of Tests S-19 through S-21.
16	Based on protection criteria recommended in Appendix D, Table D-2.2 of 1993 edition of NFPA 30, with consideration given to results of Tests S-19 through S-21.
17	Based on protection criteria recommended in Appendix D, Table D-2.2 of 1993 edition of NFPA 30, with consideration given to results of Tests S-19 through S-21.

**Table D.2(c) Summary of Fire Test References for Table 16.5.2.3**

Ref. No.	Technical Justification and Test Identifier in Directory
1	Results of Test S-33, with consideration given to results of Tests S-32 and S-34.
2	Results of Tests S-45 and S-46.
3	Results of Tests S-45 and S-46. Reduced hazard of Class IIIB liquids justifies in-rack sprinklers at every other level, rather than at every level.
4	Results of Test S-33, with consideration given to results of Tests S-32 and S-34. Use of relieving-style containers justifies reduction in in-rack sprinkler design criteria, compared to that specified in Ref. No. 1.
5	Results of Tests S-45 and S-46. Use of relieving-style containers justifies reduction in in-rack sprinkler design criteria, compared to that specified in Ref. No. 1.
6	Based on data in Ref. No. 3.

**Table D.2(d) Summary of Fire Test References for Table 16.5.2.4**

Ref. No.	Technical Justification and Test Identifier in Directory
1	Results of Test S-12, with extrapolation of data to allow increase in maximum ceiling height from 25 ft (7.6 m) to 30 ft (9.2 m).
2	Results of Test S-6, with extrapolation of data to allow increase in maximum ceiling height from 25 ft (7.6 m) to 30 ft (9.2 m).
3	Results of Test S-6 and Tests S-19 through S-21, with extrapolation of data to allow increase in maximum ceiling height from 25 ft (7.6 m) to 30 ft (9.2 m).
4	Results of Test S-51.
5	Based on data in Ref. No. 3. Use of relieving-style containers allows storage two tiers high.
6	Results of Test S-55.
7	Results of Test S-56.

**Table D.2(e) Summary of Fire Test References for Table 16.5.2.5**

Ref. No.	Technical Justification and Test Identifier in Directory
1	Results of Tests P-21 through P-31.
2	Results of Tests P-67 and P-68.

**Table D.2(f) Summary of Fire Test References for Table 16.5.2.6**

Ref. No.	Technical Justification and Test Identifier in Directory
1	Results of Test S-47.

**Table D.2(g) Summary of Fire Test References for Table 16.5.2.7**

Ref. No.	Technical Justification and Test Identifier in Directory
1	Results of Tests P-32 through P-35.
2	Results of Tests P-40 through P-43.
3	Results of Tests P-36 through P-38.

**Table D.2(h) Summary of Fire Test References for Table 16.5.2.8**

Ref. No.	Technical Justification and Test Identifier in Directory
1	Results of Test S-68.
2	Results of Test S-70.
3	Results of Test S-60.
4	Results of Test S-62.
5	Results of Test S-65.
6	Results of Tests S-57, S-58, and S-59.
7	Results of Test S-66.

**Table D.2(i) Summary of Fire Test References for Table 16.5.2.9**

Ref. No.	Technical Justification and Test Identifier in Directory
1	Results of Tests P-48, P-49, and P-50.
2	Results of Tests P-51, P-52, and P-53.

**Table D.2(j) Summary of Fire Test References for Table 16.5.2.10**

Ref. No.	Technical Justification and Test Identifier in Directory
1	Results of Tests P-54 and P-55.

**Table D.2(k) Summary of Fire Test References for Table 16.5.2.11**

Ref. No.	Technical Justification and Test Identifier in Directory
1	Results of Tests S-77 through S-82.

**Table D.2(l) Summary of Fire Test References for Table 16.5.2.12**

Ref. No.	Technical Justification and Test Identifier in Directory
1	S-61.

**Table D.3(a) Foam-Water Sprinkler Protection for Single- or Double-Row Rack Storage of Class IA Liquids in Metal Containers (Nonmiscible Liquids or Miscible Liquids with >50% by Volume Flammable Contents)**

Liquid Class	Container Size and Arrangement (gal)	Storage Height (ft)	Ceiling Height (ft)	Ceiling				In-Rack Sprinkler Protection	Note
				Sprinkler Type		Density (gpm/ft <sup>2</sup> )	Design Area <sup>c</sup> (ft <sup>2</sup> )		
				Orifice <sup>a</sup>	Response <sup>b</sup>				
IA	>5 and ≤60	25	30	STD or LO	SR	0.30	1500	Every level	1

For SI units, 1 ft = 0.3 m; 1 psi = 6.9 kPa; 1 gal = 3.8 L; 1 gpm/ft<sup>2</sup> = 40.7 L/min/m<sup>2</sup> = 40.7 mm/min.

Note:

(1) Space in-rack sprinklers on maximum 9 ft centers, staggered vertically. Base design on 30 gpm per head, with six hydraulically most remote heads operating in each of upper three levels. Sprinklers are STD or LO, QR or SR, 165°F (74°C) operating temperature, with shields. Hydraulic design can be reduced to three heads operating per level — three levels operating simultaneously when using a pre-primed foam-water system installed in accordance with NFPA 16, *Standard for the Installation of Foam-Water Sprinkler and Foam-Water Spray Systems*, and maintained according to NFPA 25, *Standard for the Inspection, Testing, and Maintenance of Water-Based Fire Protection Systems*.

<sup>a</sup>ELO sprinklers are preferred when installed according to the requirements of NFPA 13, *Standard for the Installation of Sprinkler Systems* (minimum 10 psi end head pressure). STD = standard orifice, LO = large orifice, ELO = extra-large orifice.

<sup>b</sup>SR = standard response.

<sup>c</sup>High-temperature ceiling sprinklers.

**Table D.3(b) Water Sprinkler Protection for Single- or Double-Row Rack Storage of Class IA Liquids in Metal Containers (Nonmiscible Liquids or Miscible Liquids with >50% by Volume Flammable Contents)**

Liquid Class	Container Size and Arrangement (gal)	Storage Height (ft)	Ceiling Height (ft)	Ceiling				In-Rack Sprinkler Protection	Note
				Sprinkler Type		Density (gpm/ft <sup>2</sup> )	Design Area <sup>c</sup> (ft <sup>2</sup> )		
				Orifice <sup>a</sup>	Response <sup>b</sup>				
IA	≤5	25	30	LO or ELO	SR	0.40	3000	Every level	1
	>5 and ≤60	25	30	LO or ELO	SR	0.60	3000	Every level	1

For SI units, 1 ft = 0.3 m; 1 psi = 6.9 kPa; 1 gal = 3.8 L; 1 gpm/ft<sup>2</sup> = 40.7 L/min/m<sup>2</sup> = 40.7 mm/min.

Note:

(1) Space in-rack sprinklers on maximum 9 ft centers staggered vertically, 30 gpm per head, STD or LO, QR, with shields, 165°F (74°C), six hydraulically most remote sprinklers each level (upper three levels) operating. Eight sprinklers operating, if only one level.

<sup>a</sup>ELO sprinklers are preferred when installed according to the requirements of NFPA 13, *Standard for the Installation of Sprinkler Systems* (minimum 10 psi end head pressure). STD = standard orifice, LO = large orifice, ELO = extra-large orifice.

<sup>b</sup>SR = standard response.

<sup>c</sup>High-temperature ceiling sprinklers.

**Table D.3(c) Water Sprinkler Protection for Bulk or Palletized Storage of Class IA Liquids in Metal Containers (Nonmiscible Liquids or Miscible Liquids with >50% by Volume Flammable Contents)**

Liquid Class	Container Size and Arrangement (gal)	Storage Height (ft)	Ceiling Height (ft)	Ceiling				Note
				Sprinkler Type		Density (gpm/ft <sup>2</sup> )	Design Area <sup>c</sup> (ft <sup>2</sup> )	
				Orifice <sup>a</sup>	Response <sup>b</sup>			
IA	≤5	5	N/A	STD or LO	SR	0.30	3000	1
	>5 and ≤60	5 (1-high)	N/A	LO or ELO	SR	0.60	5000	1

For SI units, 1 ft = 0.3 m; 1 psi = 6.9 kPa; 1 gal = 3.8 L; 1 gpm/ft<sup>2</sup> = 40.7 L/min/m<sup>2</sup> = 40.7 mm/min.

Notes:

(1) Minimum hose stream demand 750 gpm for 2 hours.

<sup>a</sup>ELO sprinklers are preferred when installed according to the requirements of NFPA 13, *Standard for the Installation of Sprinkler Systems* (minimum 10 psi end head pressure). STD = standard orifice, LO = large orifice, ELO = extra-large orifice.

<sup>b</sup>SR = standard response.

<sup>c</sup>High-temperature ceiling sprinklers.



**Table D.4(a) Water Sprinkler Protection for Single-, Double-, or Multiple-Row Open Frame Rack Storage of Class IIIB Liquids (Flash Point 450°F) in Plastic Containers (Nonmiscible Liquids or Miscible Liquids with >50% by Volume Combustible Contents)**

Liquid Type or Closed-Cup Flash Point (°F)	Container Size (gal)	Maximum Building or Ceiling Height (ft)	Packaging Type	Maximum Storage Height (ft)	Minimum Aisle Width (ft)	Rack Depth (ft)	Sprinkler Protection Criteria		
							Ceiling Sprinkler Type, Temperature Rating	Fire Protection Scheme or Sprinkler System Design	Fire Test Ref.*
≥450	≤5	30	Cartoned	25	8	≤9	Any	Scheme A (see 16.6.1)	1
							K-14.0 ESFR ordinary standard spray sprinkler	Scheme D (see D.4.1)	2 3
				15	8	≤9	Any	Scheme A (see 16.6.1)	1
							K-14.0 ESFR ordinary standard spray sprinkler	Scheme D (see D.4.1)	4 3
			Uncartoned or mixed cartoned and uncartoned	25	8	≤9	Any	Scheme A (see 16.6.1)	1
							Standard spray sprinkler	Scheme D (see D.4.1)	3

For SI units, 1 ft = 0.3 m.

\*See Table D.4(b) for references to fire tests on which the protection criteria given in this table are based.

**Table D.4(b) Summary of Fire Test References for Table D.4(a)**

Ref. No.	Technical Justification and Test Identifier in Directory
1	Results of Tests P-21 through P-31.
2	Results of Test P-46.
3	Results of Tests P-56 and P-57.
4	Results of Test P-44.

**D.4.1 In-Rack Sprinklers** In-rack sprinklers should be installed in accordance with 16.6.1, Fire Protection System Design Scheme “A,” or with D.4.2, Fire Protection System Design Scheme “D.” Vertical baffles should not be provided between in-rack sprinklers.

**D.4.2 Fire Protection System Design Scheme “D.”** In-rack sprinklers should be installed in accordance with Figure D.4.2(a) or Figure D.4.2(b), whichever is applicable.

**D.4.2.1** In-rack sprinklers should be listed or approved, ordinary temperature-rated, quick response sprinklers having a nominal K-factor of 8.0, and should be designed to provide 30 gpm (113 L/min) out of the hydraulically most remote eight sprinklers if one level is installed or the most remote fourteen sprinklers (seven on two levels) if two or more levels are provided.

**D.4.3 Ceiling Sprinklers.** Ceiling sprinklers should be designed to provide a minimum density of 0.3 gpm/ft<sup>2</sup> (12.2 mm/min) over the most remote 2000 ft<sup>2</sup> (185 m<sup>2</sup>) using ordinary temperature-rated, standard response spray sprinklers, having a nominal K-factor of 8.0 or 11.2.

**D.4.4 Water Demand.** The ceiling and in-rack sprinkler water demands should be balanced at the point of connection to the water supply. A 500 gpm (1900 L/min) hose stream allowance should be provided.

**D.5 Recommended Fire Protection Design Criteria for High-Expansion Foam Fire Protection for Nonpolar (Nonmiscible) Liquid.** Table D.5 provides recommended design criteria for high-expansion foam protection for Class IB, Class IC, Class II,

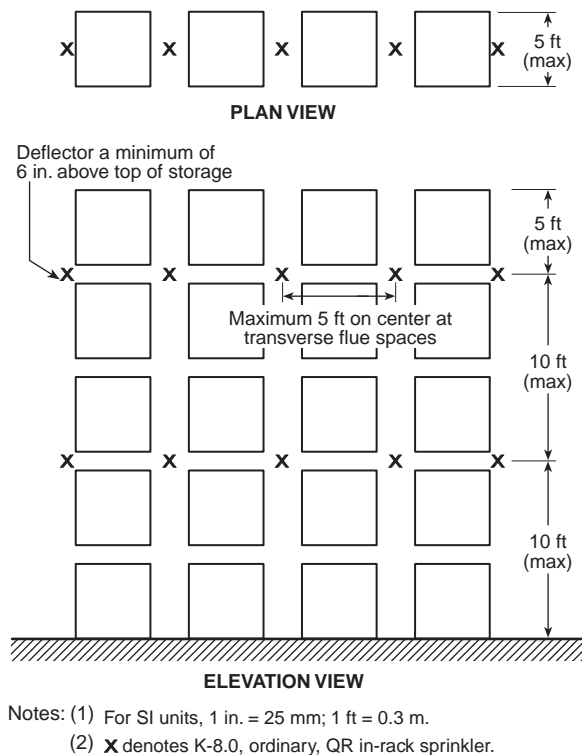

**FIGURE D.4.2(a) Single-Row Rack Sprinkler Layout for Fire Protection System Design Scheme “D.”**

and Class III liquids in plastic containers in corrugated cardboard cartons.

**D.5.1** The foam system should be designed and installed in accordance with NFPA 11, *Standard for Low-, Medium-, and High-Expansion Foam*, with this section, and with Table D.5.

**D.5.2** There should be at least two foam generator units drawing fresh inlet air from an area outside of the area being protected.

**D.5.3** Submergence time should not exceed 2 minutes for either sprinklered or unsprinklered areas. Failure of a single foam generator should not result in a submergence time exceeding 4 minutes.

**D.5.4** The foam system should be activated by a supplemental detection system capable of detecting a fire originating anywhere within the storage area. Foam system activation should be preceded by a 20-second pre-activation room egress alarm.

**D.5.5** Storage of liquids in plastic containers should be in a room separated from other occupancies by minimum 2-hour fire-rated construction. The storage room should be equipped with automatic self-closing Class A or B doors that are interlocked to the detection system.

**D.5.6** The roof or ceiling of the storage area should be provided with either of the following:

- (1) A minimum 1-hour fire-resistive protection for roof or ceiling structural members
- (2) Ceiling sprinklers at a minimum density of 0.45 gpm (18.3 mm/min) over the entire room to protect against

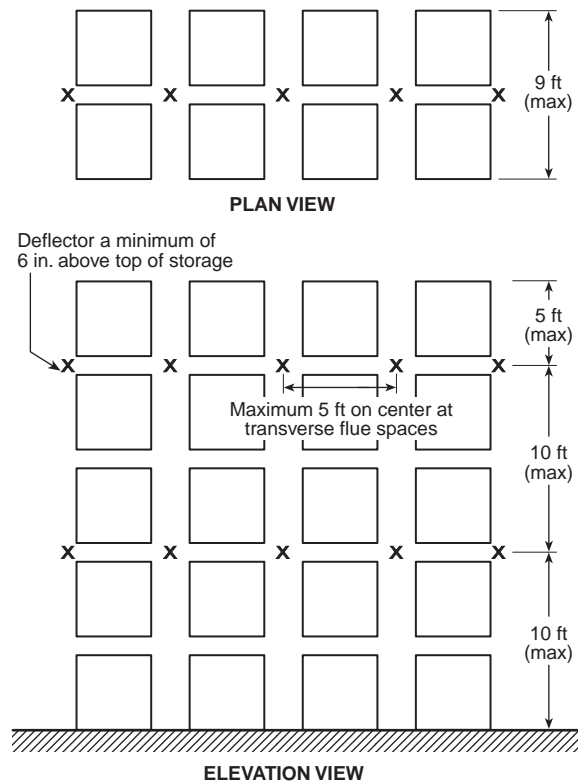

**FIGURE D.4.2(b) Double-Row Rack Sprinkler Layout for Fire Protection System Design Scheme “D.”**

high ceiling temperatures during the time required for foam submergence.

**D.5.7** Liquid containment should be provided for rooms storing liquids in plastic containers. The liquid containment should provide 4 in. (100 mm) minimum containment. Where ceiling sprinkler protection is used, a drainage and containment system capable of retaining at least 20 minutes of sprinkler discharge should be provided.

**D.5.8** Rack storage should be limited to single- or double-row racks. Bay width should not exceed 9 ft (2.7 m).

**D.5.9** Racks should be provided with vertical barriers meeting the following:

- (1) Barriers should be constructed of plywood at least  $\frac{3}{8}$  in. (10 mm) thickness or by sheet metal of at least 22 gauge thickness.
- (2) Barriers should be located at each rack upright and should extend from rack face through the flue space to the opposite rack face of the storage rack assembly.

**D.5.10** Aisle width should be not less than 7.5 ft (2.3 m).

**D.5.11** These recommendations are based on a series of fire tests conducted by Ansul, Inc. to explore the efficacy of high-expansion foam fire protection on fires involving flammable liquids in plastic containers.



**Table D.5 High-Expansion Foam Protection of Single- and Double-Row, Open-Frame Rack Storage of Class IB, IC, II, and III Nonpolar (Nonmiscible) Liquids in Plastic Containers**

Liquid Class	Container Size (gal)	Maximum Storage Height (ft)	Maximum Ceiling Height (ft)	Maximum Submergence Time (min)	Fire Detection and System Activation	Note	Fire Test Ref.
IB, IC, II, IIIA, IIIB	≤1*	18	33	2	Optical flame or equivalent	1	See D.5.11

For SI units, 1 gal = 3.8 L; 1 ft = 0.3 m.

Note: Application is limited to rooms no greater than 5000 ft<sup>2</sup> (465 m<sup>2</sup>) in size.

\*Liquids in polyethylene or polypropylene containers packaged in corrugated cardboard cartons.

## Annex E Suggested Test Protocol for Developing Fire Protection System Design Criteria for Containers of Flammable and Combustible Liquids

*This annex is not a part of the requirements of this NFPA document but is included for informational purposes only.*

**E.1 Introduction.** The development of fire protection criteria for liquids in containers relies almost exclusively on the evaluation of data from large-scale fire tests and engineering judgment. Characterization of fire development, fire spread to adjacent containers or materials, suppression system activation, and effectiveness of the suppression system based on first principles (i.e., governing scientific theory) is not well established. Reliance on actual test data for all situations and scenarios is not, however, practical from a cost standpoint. The development of the fire protection criteria in Chapter 16 of this code, therefore, relies on data from representative test scenarios and assessment of the risk. Alternative materials and scenarios are then evaluated in terms of the specific test data, historical test data, engineering experience with the hazards, and an assessment of the risk. Pending complete development of engineering tools to evaluate the fire hazards of flammable and combustible liquids, this approach represents the best method to meet the NFPA policy that codes and standards be scientifically based.

This annex provides an example protocol for the testing of flammable and combustible liquids stored in containers. In many cases, test data are then interpolated or extrapolated to develop fire protection design criteria by which the stored commodities can be considered protected. The term *protected* could be interpreted as defining storage where there is essentially zero risk of an uncontrolled incident. Because zero risk is unattainable, it is important that designers and regulators be aware of the limitations when applying the protection criteria based on fire test data and engineering extrapolation. The limitations of the protection criteria are also described in this annex.

With the introduction and widespread use of larger containers, such as intermediate bulk containers (IBCs), and the introduction of alternative container materials, there is a need to evaluate these materials from a fire performance standpoint. There is a need to provide manufacturers, warehouses, and enforcement officials with guidance on developing and evaluating protection criteria where data are not currently available. The following example test protocol is intended to outline guidance for conducting representative fire tests to establish protection criteria for liquids in containers. Specifically, this outline is developed for liquids in large containers, i.e., greater than 5.3 gal (20 L). While there is a substantial

amount of data for smaller containers, there is a lack of data for large containers. (See E.2.5 and E.2.6.) Most of these data are for 55 gal (208 L) drums.

**E.2 Example Fire Test Protocol for Evaluating Liquids in Large Containers.** Important variables in evaluating hazards for liquids in small containers have been identified (Nugent, 1994). These include liquid properties, container design and size, packaging material, ignition scenario, storage arrangement, and sprinkler system design parameters.

Of particular importance for large containers is control of pressure in the container to prevent a violent rupture and the prevention of a large discharge of liquid. While these are a problem with smaller containers, the hazard to test facilities and personnel increases dramatically for larger containers. A fundamental measure of performance is the limitation of pressure buildup in the container and maintenance of container integrity to prevent a large spill. Prevention of a violent rupture should be tempered by the discharge of liquid and associated heat release through pressure-relieving mechanisms. The pressure-relieving mechanisms can be a designed-in feature or can be inherent in the container material. Container integrity, along with pile or rack stability, is important to prevent a large discharge of liquid. Suppression systems might not be adequate to control a large release of liquid. Engineering tools are available to evaluate specific consequences of uncontrolled pool fires on facility integrity (Gewain, 1996).

The information that follows is provided to aid in the development of protection criteria similar to that developed in Table 16.5.2.1 through Table 16.5.2.4 for steel drums. The intent is to provide guidance for the acceptance of alternative materials/designs under the “protected” classification of stored liquids. The primary basis of this outline is previous testing of drum storage (e.g., Newman et al., 1975).

### E.2.1 Storage Configuration.

**E.2.1.1 Facility.** If containers are to be protected indoors, tests should be conducted in an enclosed facility with minimal impact from the outside environment. In particular, the building height should be representative of the proposed indoor storage height. Building height affects response time of the suppression system, penetration of suppression agent through the fire plume, and response of building structural elements to the threat.

**E.2.1.2 Storage Array.** A representative array should be selected (e.g., solid pile storage or rack storage). Arrays should consider the width of aisles to adjacent stored materials and whether these materials have higher or lower ignition and fire growth characteristics.

**E.2.1.3 Container.** The container storing the liquid should be representative of a production-type unit, unless the evaluation is a scoping series to determine container effects. Potential venting capabilities of a container should be identified (i.e., the thermally “weak link” of the constructed assembly). If the container will have an outer wrapping, packaging, or pallet, this should be considered in the overall “container” system.

**E.2.1.4 Liquid in Container.** The most hazardous liquid to be stored should be evaluated. The hazard of a liquid should be assessed based on its volatility (vapor pressure), heat of combustion, specific gravity, miscibility (water solubility), ignition temperature, flash point, fire point, boiling point, and vapor density. The NFP 30 rating system, based on flash point, vapor pressure, and boiling point, can be used as a guide to assess the hazard. The other properties should be considered, as they can affect both the hazard and the suppression system effectiveness.

**E.2.1.5 Liquid Classes.** Class IA liquids should be considered independently from other liquids because of their inherent hazards. Protection criteria can be developed for different classes of liquids, for example, motor oils that have protection criteria different from those for Class IB liquids. For a maximum reasonable hazard, n-heptane has been used for general evaluation for liquids up to and including Class IB. When tests are performed on large containers, water can be substituted in place of the actual flammable liquid to improve the overall safe conduct of the test. It is important to include liquid in the container. Internal pressure should be recorded. The liquid also serves as a heat sink for the container. Structural failure of the container can occur where there is no liquid interfacing with the container (Newman et al., 1975). The container ullage (vapor space) should be representative of actual conditions.

## E.2.2 Fire Protection System.

**E.2.2.1** The fire protection system proposed for adoption should be represented in the actual test (e.g., deluge sprinkler system, wet or dry pipe closed-head system, foam system, or gaseous agent system). Where system actuation is dependent on auxiliary equipment (e.g., detectors), these devices should be included in the test with representative spacing and response characteristics.

**E.2.2.2** For sprinkler suppression systems, representative application rates and sprinkler spacing that would be proposed for adoption should be used.

**E.2.2.3** For tests involving closed-head sprinklers, appropriate sprinkler orifice sizes, temperature rating, and response time index (RTI) should be identified and utilized.

**E.2.2.4** For deluge and gaseous agent system tests, appropriate detection equipment proposed for protection should be used in testing.

**E.2.2.5** For foam system tests, prepriming or the actual foam discharge time from sprinklers should be addressed. The foam concentrate should be listed or approved for the type of liquid.

## E.2.3 Fire Scenario.

**E.2.3.1** The fire scenario is crucial in determining the hazard of the stored product. It is recognized that an installed suppression system might not be able to protect against an absolute worst-case scenario (e.g., the total release of multiple stor-

age containers). For large containers, the rapid release of contents can pose a significant challenge to an installed suppression system. This is particularly true if it is a highly volatile liquid (e.g., Class I liquid). The philosophy for determining protection effectiveness is predicated on a reasonable anticipated threat. Even with an installed suppression system, there is some risk of a significant loss. Part of this risk is associated with suppression system reliability, which should be addressed in the actual design/specification of protection systems.

**E.2.3.2** A representative scenario for large containers was developed during drum storage tests (Newman et al., 1975). The scenario was a liquid gravity leak of 2 gpm to 15 gpm (7.6 L/min to 56.7 L/min) from a hole at or near the bottom of a container. This leak can be simulated by flow from a pipe. If containers are stacked or placed more than one high, then the simulated container leak should be placed high in the total array. The leak should be allowed to flow prior to ignition, simulating fuel spread after the mishap and a delay in ignition. In the tests, 10 gal (38 L) of liquid was allowed to spill before ignition. Additional details on the effects of spill rate and initial spill size for tests involving an aqueous film-forming foam suppression system are provided in other references (Young and Fitzgerald, 1975).

An alternative worst-case scenario could be the total release of liquid from a large container, with ignition delayed until the contents are totally discharged. Ignition of this large pool fire can severely challenge an installed suppression system.

**E.2.3.3** If the scenario involves a flowing fuel fire, the recommended length of the test should be equal to the total time of the flow from one container. Alternatively, the evaluation can be terminated shortly after total extinguishment. Time should be allowed to determine any post-extinguishment pressure buildup in containers or subsequent container failure due to inadequate cooling. For water and foam systems, fire control will likely be the measure of performance instead of extinguishment because it is unlikely that the three-dimensional running fuel fire will be extinguished with these agents. If a larger spill rate is used, a reduced test time equal to the time to discharge the contents of one container can be appropriate. The length of a pool fire test would be based on the success or failure of the suppression system to control or extinguish the fire. For portable tanks and intermediate bulk containers, a specific length of fire protection time can be identified.

## E.2.4 Measures of Performance.

**E.2.4.1 Criteria.** Acceptable performance should include, but not be limited to, the following:

- (1) Prevent pressure buildup in containers or actual violent ruptures
- (2) Prevent substantial loss of liquid from a container
- (3) Limit the number of sprinklers operating
- (4) Prevent ignition of adjacent target arrays or failure to control a fire in an adjacent target array
- (5) Limit temperature of structural or rack steel
- (6) Control sustained ceiling gas temperatures
- (7) Prevent collapse of the stored containers or arrays

**E.2.4.2 Type of Container.** The type of container material will affect the establishment of the performance criteria. The prevention of a violent rupture is an important characteristic. The loss of some liquid from a container (particularly by controlled venting) can be deemed acceptable or even preferable. Catastrophic failure of a container (e.g., total content release)



can be deemed unacceptable. The resulting large spill might not be controlled (particularly if water sprinklers are used) and can lead to cascading container failures.

**E.2.4.3 Preliminary Testing.** Scoping tests can be required to determine failure mechanisms and worst-case situations for specific container materials. An example of scoping tests performed to determine failure mechanisms of small metal and plastic containers is detailed in a research report by Hill (1991). Steel drum failure mechanisms are described in a research report by Newman and others (1975). There is a lack of published information on large container failure mechanisms, particularly for IBCs and nonmetallic or composite drums (e.g., fiber drums).

**E.2.4.4 Pressure Buildup.** A gauge pressure of 15 psi (103 kPa) is an example of a critical pressure in steel drums, above which violent rupture can occur (Newman et al., 1975). Many drums are now rated at a gauge pressure of 44 psi (300 kPa), and some might be rated as high as 70 psi (480 kPa).

**E.2.4.5 Loss of Liquid.** Loss of any substantial amount of liquid from a container is generally considered as a criterion for failure. For the originally involved container, this can be loss of contents at a rate greater than the design scenario spill rate. Fire spread to the outer limits of the test array is generally considered a failure. For adjacent or target arrays, the level of fire involvement should be considered. Loss due to vapor venting can be considered acceptable. For metallic containers, loss of liquid to a violent rupture can be considered unacceptable.

**E.2.4.6 Number of Sprinklers Operating and Operating Time.** The number of sprinklers operating and their operating time can be used as a judgment of overall suppression system effectiveness. As the number of sprinklers operating increases, the probability of overall success decreases. The philosophy in combustible liquid and flammable liquid protection has shifted from traditional warehouse success criteria, where a “success” could be judged for a test involving the operation of 30 or more sprinklers. The trend in liquid protection is for more rapid actuation and cooling and control through the use of lower RTI, intermediate level, larger orifice, and ESFR sprinklers.

**E.2.4.7 Ignition of Target Arrays.** Prevention of the ignition of adjacent targets (e.g., across aisles) is a fundamental measure of performance. If target arrays ignite, adequate protection should be provided (e.g., through the use of in-rack sprinklers or increased suppression agent rate).

**E.2.4.8 Integrity of Structural Steel.** Structural steel, in the form of building columns, beams, or rack elements, potentially fails at about 1200°F to 1300°F (650°C to 700°C). Scenarios where elements reach this temperature for any prolonged time can be judged unsuccessful for “protected” situations.

**E.2.4.9 Integrity of Storage Array.** Collapse of stored containers inherently increases the risk of container liquid discharge. It also increases the potential for shielding of a flowing fuel or pool fire, with a resulting increase in violent rupture potential or catastrophic liquid discharge.

**E.2.4.10 Spills.** Spills of any magnitude might not be suppressed by water-only suppression systems. Water can act to cool containers, but it also spreads the pool fire. For situations where there is the potential for large spills, floor drainage systems can be used to mitigate the spread of burning liquids. The area contained within the drains can be considered for

establishing sprinkler design operating areas. Alternatively, foam-water sprinkler systems can be used to control/suppress floor pool fires to prevent burning liquid spread. Where there is rack storage, in-rack sprinklers at every level have demonstrated good cooling for drum storage (Newman et al., 1975).

**E.2.4.11 Test Documentation.** Test documentation should include test setup, results, and damage assessment. Photographic and video documentation is desirable.

## **E.2.5 Probability of a Fire Incident and Reliability of Suppression Systems.**

**E.2.5.1** Inherent in the current “protected” concept of Chapter 16 is a qualitative judgment of unacceptable and acceptable risk. If all other relevant fire and property loss parameters are equal, “unprotected” facilities have a greater relative risk of experiencing an uncontrolled fire that will result in a large loss than will “protected” facilities. An essential part of a risk analysis is identifying all the factors that will contribute to the probability of a fire incident. In addition, the factors leading to a nonoperable suppression system need to be identified. Only after comparing these two probabilities, fire event and system failure, can an accurate assessment of risk be accomplished.

Minimizing the risk in either unprotected or protected facilities can be accomplished by reducing the probability of a fire. These types of “fire safety” practices are common and range from good housekeeping and other management program controls to inherently less combustible and ignitable process and facility designs. This encompasses a broad range of elements, but all contribute to lessening the probability of a fire. In undertaking a risk-based approach to fire safety, as many as possible of these contributing elements should be identified. Once this is done, steps should be taken, within the set of identified elements, to reduce or eliminate their individual probability of occurring.

**E.2.5.2** In facilities where fire suppression systems are used to reduce the risk of loss due to fire, the suppression system should be examined to determine its reliability. Suppression systems are multicomponent assemblies, and determining the reliability of the system involves knowing or estimating, within acceptable limits, the probabilities of failure of the individual components or subsystems. It is also essential to understand the conceptual design of the system as it relates to interaction of the components. One method of assessing reliability is by using the system schematics to construct fault trees. The fault trees then serve as system models, and the failure probabilities are propagated through calculation to determine the overall probability of system failure. The fault trees can be extended by additional “AND” logic gates (fire event at the same time as system failure) to determine the suppression system’s conditional probability of failure.

**E.2.5.3** As with any quantitative probabilistic analysis, the quality of the data used to determine the estimated failure probabilities tends to be the weak link in the analysis. Data on component failure rates and estimates of fire event probability can lack adequate rigor. Incorporating expert opinion on system performance can be desirable or even required, if data are lacking. In addition, the uncertainty inherent in all statistical analysis should be reported for the failure probabilities.

**E.2.6 Limitations of Testing and Protection Criteria.** The objective of fire testing of large containers is to evaluate plausible scenarios. Attempts have been made to address variables that would contribute to failure or successful protection. All scenarios



and probabilities are not addressed by virtue of the limited number of large-scale tests that can be practically conducted and inherent risks that are deemed acceptable, even with protected storage. Protection can be interpreted to mean control, suppression, or extinguishment of a fire for any given scenario. Subsection E.2.6 outlines issues and limitations associated with protected storage.

**E.2.6.1 Ignition and Threat Scenarios.** Worst-case scenarios (i.e., arson or terrorism) associated with breaches of multiple large containers have not been investigated. In such a scenario, the suppression system could also be rendered inoperative. Protected storage, as intended by this code, does not address this scenario. Attempts have been made in testing to develop a reasonable scenario that is challenging to the commodity and plausible under routine warehouse conditions. Different packaging systems could be more or less vulnerable to different scenarios. Small containers stored in corrugated cartons appear more vulnerable to small ignition sources because of delayed sprinkler actuation. Large containers could also react differently to the initiating scenario, depending on construction of the package. Large containers are typically tested with a relatively small initiating spill and a running fuel source. A large initial spill (i.e., where all the fuel in a container has emptied and is ignited) has not been tested. The relatively short duration of a large, thin spill fire is considered to be addressed by the threat of a much longer duration, shielded running fuel fire. A full range or combination of tests of initial spill size and spill rate has not been made. The philosophy in large container testing is to assume an initial container breach and provide control such that multiple containers do not breach and contribute to a much larger spill.

**E.2.6.2 Water and Foam Sprinklers.** Water sprinklers will not extinguish most flammable or combustible liquid fires. At best, water sprinklers will control or extinguish the fire in any associated combustible packaging material. Yet, most of the systems used in the protection criteria tables in Section 6.8 of this code are based on water sprinklers, based on the recognition of the following:

- (1) A large spill with small containers is unlikely, although not impossible, provided the sprinklers operate to control cascading breaching of containers.
- (2) There is sufficient cooling of larger containers to prevent multiple container breaching.

For large containers, some form of spill containment (e.g., by drainage) is required for protected storage. The intent is to limit the size of the spill and the resulting area of sprinkler operation. There has been little quantification of the appropriate design factors and effectiveness of drainage systems. For example, will protection be provided for a 4000 ft<sup>2</sup> (370 m<sup>2</sup>) area that is fully involved in fire? The duration of the fire could influence the effectiveness of such protection.

Foam sprinklers are generally effective on pool (floor) fires but are likely to be ineffective on running, three-dimensional spill fires. Again, total control or extinguishment of the fire cannot be assured.

**E.2.6.3 Anticipated Duration of the Fire.** For large containers, particularly those greater than 55 gal (208 L) in capacity, there is an inherent assumption that manual fire-fighting efforts will be initiated to finalize control and extinguishment of the fire. For example, foam systems are required to have a duration of 15 minutes. This implies that some action will be taken when the system has been expended. The protection criteria for

composite intermediate bulk containers were developed based on a 30-minute fire resistance for the container. Again, action to secure the situation after this time is assumed. The protection criteria for containers greater than 60 gal (225 L) capacity, as outlined in Table 16.5.2.1 through Table 16.5.2.4 and Table 16.5.2.9, provide reasonable containment confidence for a 30-minute fire exposure. Due to the capacity of intermediate bulk containers and portable tanks, it is imperative that response by a private fire brigade or public fire department be capable of initiating fire suppression activities promptly within this period.

Detection, notification, and prompt action by responsible personnel are implicit in the protection criteria. The protection system per se provides thermal detection. In some cases, more rapid detection could be desired. Considerations in evaluating appropriate detection requirements include level of fire department staffing, availability of an on-site fire brigade, and availability of off-site notification by a private service company.

Compliance with local and federal hazardous materials rules and regulations could result in delayed fire department action at the scene of a warehouse fire. Fire departments should also respond to fires in these occupancies with foam fire-fighting equipment to effect final extinguishment. The authority having jurisdiction should assess the capability of the fire department to effectively respond to the incident when implementing the protection criteria in this code. The selection of an approach to fire protection for these occupancies is influenced by the authority having jurisdiction, potential community or environmental exposures, investment at risk, insurance considerations, and business continuity.

### E.3 References for Annex E. See also I.1.3.

Gewain, R. G., "Fire Protection of Aerosol Products," *Southern Building Magazine*, September/October, 1996, pp 10-12.

Hill, J. P., "International Foam-Water Sprinkler Research Project: Task 3 — Range Finding Tests," Factory Mutual Research Report J.I. OTOR6.RR, prepared for the National Fire Protection Research Foundation, Norwood, MA, July 1991.

Newman, R. M., Fitzgerald, P. M., and Young, J. R., "Fire Protection of Drum Storage Using 'Light Water' Brand AFFF in a Closed-Head Sprinkler System," Factory Mutual Research Corporation Report FMRC Ser. No. 22464, RC75-T-16, Norwood, MA, March 1975.

Nugent, D. P., "Fire Tests Involving Storage of Flammable and Combustible Liquids in Small Containers," *Journal of Fire Protection Engineering* 6(1):1994; 1-10.

Young, J. K., and Fitzgerald, P. M., "The Feasibility of Using 'Light Water' Brand AFFF in a Closed-Head Sprinkler System for Protection Against Flammable Liquid Spill Fires," Factory Mutual Research Report FMRC Ser. No. 22352, RC75-T-4, Norwood, MA, January 1975.

**E.4 Bibliography.** Please note that reports by Factory Mutual Research Corporation (FMRC) cited in the bibliography might not be available to the general public. FMRC reports cited in the references are on file at NFPA Headquarters in the NFPA 30 committee files. (See also Section I.2.)

Allahdadi, F. A., Luehr, C., Morehouse, T., and Campbell, P., "Modeling Response of Tanks Containing Flammables to Fire Impingement," ESL-TR-87-53, Engineering and Services Laboratory, Tyndall AFB, FL, July 1988.

American Petroleum Institute, API 2000, "Venting Atmospheric and Low Pressure Storage Tanks," API, Washington, DC, 1982.



Bainbridge, B. L., and Keltner, N. R., "Heat Transfer to Large Objects in Large Pool Fires," SAND-87-0641C, Sandia National Laboratories, Albuquerque, NM, 1987.

Birk, A. M., "Modeling the Effects of a Torch-Type Fire Impingement on a Rail or Highway Tanker," *Fire Safety Journal*, 15 (1989): 277–296.

Committee on Hazardous Materials, Division of Chemistry and Chemical Technology, National Research Council (ed.), *Pressure-Relieving Systems for Marine Cargo Bulk Liquid Containers*, National Academy of Sciences, Washington, DC, 1973.

Factory Mutual Laboratories, Research Project No. 11365, November 2, 1949, "Fire Tests of Vent Fittings for Paint Drums," Laboratory Report No. 13604, February 1958; 26.

Hall, J. R., Gandhi, P. D., and Sheppard, D. T., *Fire Risk Analysis for Flammable and Combustible Liquid Project — Containers in Storage and Retail Occupancies*, National Fire Protection Research Foundation, Quincy, MA, February, 1994.

Hall, J. R., "A Fire Risk Analysis Model for Assessing Options for Flammable and Combustible Liquid Products in Storage and Retail Occupancies," *Fire Technology*, Vol. 31, No. 4, 1995, pp. 291–306.

Houser, J., et al., "Vent Sizing for Fire Considerations: External Fire Duration, Jacketed Vessels, and Heat Flux Variations Owing to Fuel Consumption," *Journal of Loss Prevention in the Process Industries*, 14 (1998): 403–412.

Johnson, M. R., "Temperatures, Pressures and Liquid Levels of Tank Cars Engulfed in Fires — Volume I, Results of Parametric Analyses," DOT/FRA/OR&D-84/08.11, Federal Railroad Administration, Washington, DC, June 1984.

McLain, W. H., "Investigation of the Fire Safety Characteristics of Portable Tanks — Polyethylene Tanks Containing Flammable Liquids," Report No. CG-M-1-88, U.S. Coast Guard Marine Technical and Hazardous Materials Division, Avery Point, CT, March 1988.

Nugent, D. P., Freeman, J. L., and Oliszewicz, M. P., *Guidelines for Safe Warehousing of Chemicals*, Center for Chemical Process Safety, American Institute of Chemical Engineers, New York NY, 1998, pp 113–119.

Richards, R. C., and White, K. T., "Fire Exposure Tests of Polyethylene and 55 Gallon Steel Drums Loaded with Flammable Liquids, Phase I," Report No. CG-D-116-76, Department of Transportation, U.S. Coast Guard, Washington, DC, September 1976.

Richards, R. C., and Munkenbeck, G. J., "Fire Exposure Tests of Polyethylene and 55 Gallon Steel Drums Loaded with Flammable Liquids, Phase II," Report No. CG-D-86-77, Department of Transportation, U.S. Coast Guard, Washington, DC, August 1977.

Rogerson, J. E., "Flammable and Combustible Liquid Drum Storage Problems," American Institute of Chemical Engineers Summer National Meeting Progress, Paper No. 63, 1981.

Russell, L. H., and Canfield, J. A., "Experimental Measurement of Heat Transfer to a Cylinder Immersed in a Large Aviation Fuel Fire," *Journal of Heat Transfer*, August 1973.

Scheffey, J. L., *International Intermediate Bulk Container Fire Test Project — Scoping Tests*, National Fire Protection Research Foundation, Quincy, MA, September 1996.

Scheffey, J. L., Sheppard, D. T., and Stepan, D., *International Intermediate Bulk Container Fire Test Project — Required Delivered Density Tests*, National Fire Protection Research Foundation, Quincy, MA, April 1997.

Scheffey, J. L., Pabich, M., and Sheppard, D. T., *International Intermediate Bulk Container Fire Test Project — Phase IIA —*

*Evaluation of Large Arrays*, National Fire Protection Research Foundation, Quincy, MA, April 1998.

Scheffey, J. L., Pabich, M., and Sheppard, D. T., *International Intermediate Bulk Container Fire Test Project — Phase IIB — Verification Tests and Development of Standardized Evaluation*, National Fire Protection Research Foundation, Quincy, MA, April 1998.

Schemel, S. D., et al., "Methodology for Determining Reliability of a Foam Suppression System Using Fuzzy Set Theory and Fault Tree Analysis," *Proceedings of the International Conference and Workshop on Reliability and Risk Management*, Center for Chemical Process Safety, American Institute of Chemical Engineers, 1998.

Silicone Products Department of General Electric, "Bulging and Rupture Characteristics of 55-Gallon, Steel Closed-Top Drums at Known Pressure," Company Report No. R-65-Ch-SD-529, September 30, 1965.

Sumitra, P. S. and Troup, J. M. A., "The Effect on Sprinkler Protection of Using Thin Pallets for Palletized Barreled Whiskey Storage," FMRC J.I. OEOR1.RR, RC 79-T-60, March 1980.

Sumitra, P. S. and Troup, J. M. A., "Fire Protection Requirements for Six-Barrel High Palletized Storage of Distilled Spirits," FMRC J.I. OC2R6.RR, RC 78-T-42, February 1979.

Sumitra P. S. and Troup, J. M. A., "The Protection Requirements for Six-Barrel High Palletized Storage of Distilled Spirits, Phase II," FMRC J.I. OEOR1.RR, RC 79-T-66, November 1979.

Tavares, R. and Delichatsios, M. A., "Pressure Relief in Flammable-Liquid Drums by Pressure-Activated and Plastic Bunds," FMRC J.I. OFOR4.RA 070(A), Factory Mutual Research Corporation, Norwood, MA, March 1981.

Technical Report on Storage of Palletized Isopropyl Alcohol, Project 96NK33044/NC1838, Prepared for HSB Industrial Risk Insurers, Underwriters Laboratories, Inc., Northbrook, IL, April 18, 1997.

Technical Report of Running Alcohol Fuel Fires Within Rack Storage of Plastic Drums, Project NC183897NK31221, Revised Draft, Underwriters Laboratories Inc., Northbrook, IL, July 15, 1998.

Yao, C., "Flammable Liquid Drum Fire Protection System Development," FMRC Report No. 16425, prepared for the Manufacturing Chemists Association, Norwood, MA, May 5, 1967.

## Annex F Fugitive Emissions Calculations

*This annex is not a part of the requirements of this NFPA document but is included for informational purposes only.*

**F.1 Introduction.** An alternative method of providing adequate ventilation for an enclosed area is by making a reasonable estimate of fugitive emissions from hydrocarbon-handling equipment within the enclosed area and providing sufficient diluent ventilation. Application of this method requires certain calculations, and one technique is described in Section F.2.

In calculating the ventilation rate required, the anticipated hydrocarbon leakage rate (under normal conditions) should be determined. Then, sufficient dilution air should be added to the space in question to ensure that the concentration of flammable vapor/gas is maintained below 25 percent of the lower flammable limit (LFL) for all but periods of process upset, abnormal operation, or equipment rupture, or breakdown.

Fugitive emission factors for specific hydrocarbon-handling equipment can be obtained from emission testing at specific facilities or from existing publications. A few existing publications are API's *Fugitive Hydrocarbon Emissions from Petroleum Production Operations*, Volumes I and II, 1980; EPA/*Radian Study* conducted in 1979; and EPA *Protocols for Generating Unit-Specific Emission Estimates for Equipment Leaks of VOC and HAP*. All emission data used should be reviewed to assure emission rates are representative of actual conditions during normal operations.

**F.2 Calculation Technique.** In the following example, the required ventilation rate will be determined for an enclosed area on a cold-weather, offshore platform containing production equipment that measures 60 ft by 120 ft (18 m by 36 m) by 40 ft (12 m) high. The following procedure applies:

- (1) List the total applicable hydrocarbon-handling components and their anticipated total hydrocarbon fugitive emissions. The fugitive emissions equipment component leak rates can be obtained from emission measurements at the facility in question, from one of the existing publications listed in Section F.1, or from other studies that are representative of the equipment involved.
- (2) The total number of specific components handling hydrocarbons should be obtained by an actual field count for existing equipment or from the design drawings for proposed equipment. Note that components handling gas should be listed separately from those handling liquid hydrocarbons.
- (3) Determine the total anticipated gas emission (pounds/day) for each component by multiplying the number of components by the applicable prediction factor. This product is the total gas emission anticipated for that specific type component.
- (4) Subtotal the total anticipated gas emissions (pounds/day) for all components to obtain the total gas service emission rate.
- (5) Repeat Steps (2) through (4) to determine the hydrocarbon liquids total anticipated emissions.
- (6) Add the subtotals from Steps (4) and (5) to determine the total anticipated emissions.
- (7) Convert the total hydrocarbon emission from pounds/day to pounds/hour. For the example chosen, assume that the total anticipated hydrocarbon emissions is 297.3 lb/day (135 kg/day). Dividing by 24, the conversion yields 12.4 lb/hr (5.6 kg/hr).
- (8) Calculate the average mole weight of the hydrocarbon emissions. An example follows:  
 83% methane (molecular weight = 16)  
 13% ethane (molecular weight = 30)  
 4% butane (molecular weight = 58)  
 100%  
 $0.83 \times 16 = 13.28$   
 $0.13 \times 30 = 3.90$   
 $0.04 \times 58 = 2.32$   
 Total = 19.50  
 To simplify further calculations, the 19.5 is rounded to 20, and 20 is used as the average mole weight of the hydrocarbon emissions mixture.
- (9) Calculate the cubic feet/pound-mole at the estimated ambient temperature of the area. This calculation is made utilizing the fact that the volume of 1 pound-mole of an ideal gas is 359 ft<sup>3</sup> (10.2 m<sup>3</sup>) at 32°F (0°C) and an absolute pressure of 14.7 psi (101 kPa).

From the Gas law ( $PV = nRT$ ) and Charles' Gas law ( $V_1 T_2 = V_2 T_1$ ), and from the fact that volume at constant pressure varies proportionately to the ratio of temperatures when the temperature is expressed in degrees Rankine ( $^{\circ}\text{F} + 460$ ), calculate the actual volume. Assuming an ambient temperature of 88°F (31°C), an example follows.

At 88°F (31°C) and an absolute pressure of 14.7 psi (101 kPa), 359 ft<sup>3</sup> (10 m<sup>3</sup>) of ideal gas would occupy:

$$359 \left( \frac{460 + 88}{460 + 32} \right) \text{ or } 400 \text{ ft}^3 \quad [\text{F.2(a)}]$$

- (10) Determine the total hydrocarbon leak rate in cubic feet per minute (cfm) using the following equation:

$$G = \frac{(E)(V)}{60(mw)} \quad [\text{F.2(b)}]$$

where:

$G$  = leak rate (cfm)

$E$  = emissions rate (lb/hr)

$V$  = volume (ft<sup>3</sup>/lb-mole)

60 = min/hr

$mw$  = average mole weight

In our example,  $E$  equals 12.39 lb/hr (5.6 kg/hr), and the average mole weight is 20; therefore,  $G$  can be calculated as follows:

$$G = \frac{(12.39 \text{ lb/hr})(400 \text{ ft}^3/\text{lb-mole})}{(60 \text{ min/hr})(20)} \quad [\text{F.2(c)}]$$

$$G = 4.13 \text{ cfm}$$

- (11) As given in NFPA 69, *Standard on Explosion Prevention Systems*, the hydrocarbon concentration can be expressed by the following equation:

$$C = \left( \frac{G}{Q} \right) (1 - e^{-kn}) \quad [\text{F.2(d)}]$$

where:

$C$  = concentration of hydrocarbon in air, %  
 expressed as a decimal

$G$  = leak rate (cfm)

$Q$  = fresh air introduction rate (cfm)

$e$  = 2.7183

$k$  = mixing efficiency factor = 0.2 to 0.9

$n$  = number of air changes

The factor  $(1 - e^{-kn})$  can be considered equal to 1 because as the number of air changes ( $n$ ) approaches steady state (i.e., approximately three air changes), this factor approaches unity.

As an example, if the leakage rate is assumed to be 4.13 cfm (0.12 m<sup>3</sup>/min), 100 percent LFL methane is assumed (5 percent concentration), and it is desired to maintain a 25 percent LFL mixture, the required fresh air introduction rate can be determined as follows:

$$Q = \frac{4.13 \text{ cfm}}{(0.25 \times 0.05)} \quad [\text{F.2(e)}]$$

$$Q = 330 \text{ cfm}$$



- (12) Due to the variations in emission factors for processing equipment, the calculated rate should be multiplied by a safety factor of 4. The required ventilation rate is determined as follows:

$$Q = 330 \text{ cfm} \times 4 \quad \text{[F.2(f)]}$$

$$Q = 1320 \text{ cfm, the minimum ventilation rate}$$

Thus, minimum ventilation to achieve adequate ventilation for an enclosed area of the size given in the example that contains the fugitive emissions sources assumed is 1320 cfm (37.4 m<sup>3</sup>/min).

- (13) Depending on the size of the enclosed area and the equipment configuration, supplemental internal recirculation could be advisable to avoid areas of stagnation. With higher local concentrations where recirculation is justified, it should be designed with adequate air movement and direction to minimize “dead” areas where vapor can collect. If other criteria are lacking, a recirculation rate of 1 cfm/ft<sup>2</sup> (0.3 m<sup>2</sup>/min/m<sup>2</sup>) of floor area can be used.
- (14) If conditions exist where there is a substantial risk of a large flammable vapor release in a confined space and the calculated rate of diluent ventilation is not sufficient to dilute and disperse the released vapor to below the LFL within 4 hours, then supplemental emergency ventilation should be produced. This can be by natural ventilation through panels or louvers, or by switching recirculation fans to full fresh air make-up, or exhaust. Consideration should be given to the travel direction of ventilated vapor to avoid its reaching an ignition source outside the enclosed space being ventilated.
- (15) The preceding procedure is adapted from “Module Ventilation Rates Quantified,” *Oil and Gas Journal*.

## Annex G Management of Security

*This annex is not a part of the requirements of this NFPA document but is included for informational purposes only.*

**G.1 General.** The process used to assess the level of security of a facility is generally referred to as security vulnerability assessment (SVA). The following published guidelines are available to assist the owner and management of a facility to identify, evaluate, and control security hazards:

- (1) NFPA 730, *Guide for Premises Security*
- (2) American Institute of Chemical Engineers–Center for Chemical Process Safety (CCPS), *Guidelines for Analyzing and Managing the Security Vulnerabilities of Fixed Chemical Sites*
- (3) API Security Guidelines for the Petroleum Industry
- (4) API RP 70, *Security for Offshore Oil and Natural Gas Operations*
- (5) API RP 70I, *Security for Worldwide Offshore Oil and Natural Gas Operations*
- (6) API Standard 1164, *SCADA Security*
- (7) API/National Petrochemical and Refiners Association, *Security Vulnerability Assessment Methodology*
- (8) American Chemistry Council (ACC), *Site Security Guidelines for the U.S. Chemical Industry*
- (9) ACC *Implementation Resource Guide for Responsible Care Security Code of Management Practices: Value Chain Activities*

- (10) ACC *Transportation Security Guidelines for the U.S. Chemical Industry*
- (11) DOT, Office of Pipeline Safety, Pipeline Security Information Circular, Information of Concern to Pipeline Security Personnel, *Security Guidance for Natural Gas, and Hazardous Liquid Pipelines and Liquefied Natural Gas Facilities*, September 5, 2002
- (12) Sandia National Laboratories “Vulnerability Assessment Methodology for Chemical Facilities (VAM-CF)”
- (13) U.S. Coast Guard NVIC 11-02 (and other NVICs)

In some cases, a terrorist attack or similar worst-case event will create response complications, such as interruptions to communication between and among the facility fire brigade or response team; facility management, and response personnel and outside agencies; damage to response equipment, or loss of needed personnel. Existing emergency response plans should be updated to address and mitigate such identified potential disruptions to an effective response. Periodic tabletop and full-scale drills are strongly recommended to provide a means for proper training and identification of plan weaknesses to be addressed.

**G.2 Assessing the Facility.** Generally, the steps to be taken for SVA include the following:

- (1) Complete a high-level assessment for each chemical facility, based on the following categories:
  - (a) S = Severity/consequences
  - (b) D = Difficulty of attack (protection/level of security)
  - (c) A = Attractiveness (media attention)
- (2) Set timelines based on level of risk, completing higher-risk facilities first, by:
  - (a) Encouraging quick reaction by company for enhancements
  - (b) Making allowances in timeline for permits, construction, and capital investments
- (3) Develop an Asset/Threat Matrix/Pairing to pair each asset and threat to identify and evaluate potential vulnerabilities related to process security events. Assets include, but are not limited to, the following:
  - (a) Chemicals processed, stored, manufactured, or transported
  - (b) Storage tanks and processing vessels
  - (c) Piping and materials transfer systems
  - (d) Raw materials and intermediate products
  - (e) Process control systems
  - (f) Operating personnel
  - (g) Finished product
  - (h) Utilities (electrical power, water, fuels, telecommunications systems)
    - (i) Wastewater treatment facilities
    - (j) Business information and business management computer systems
  - (k) Business interruption and ability to service customers
  - (l) Corporate image
  - (m) Community and customer relations

**G.3 Evaluate Vulnerabilities.** Examples of threats include the following:

- (1) Loss of containment
- (2) Sabotage
- (3) Cyber attack
- (4) Workplace violence
- (5) Theft or fraud

- (6) Product contamination
- (7) Infiltration by adversaries
- (8) Attack on the facility as part of chemical or biological terrorism
- (9) Assault
- (10) Trespassing that results in vandalism or arson, or incendiaryism
- (11) Theft of precursor chemicals for illegal drug manufacture (possibly resulting in valves being left open, causing a chemical release)
- (12) Civil unrest or protest that disrupts operations (e.g., trespassing, vigils, assemblies, rallies, intimidation of employees, chaining selves to plant, or blocking access)
- (13) Bomb threats
- (14) Workplace drug crime
- (15) Theft of confidential information
- (16) Hacking into information systems to disrupt computer-controlled equipment (perhaps causing an unplanned release of chemicals)
- (17) Product tampering
- (18) "Hands-off" threats (e.g., cutting off electricity, telephone, or computer network, or contaminating or cutting off water)
- (19) Vandalism of control rooms and equipment and destruction of system documentation (to make repair more difficult)
- (20) Disruption of cooling systems for electronic equipment rooms
- (21) Creating destructive or hazardous conditions by modifying fail-safe mechanisms or tampering with valves (in person or electronically from a distance)

**G.4 Assess Threats/Consequences.** Such assessment includes the following:

- (1) Identification of potential adversaries
- (2) Review of characteristics of adversaries
- (3) Identification of means by which threats are made, such as the following:
  - (a) Intentional release of hazardous chemicals by damaging equipment or by other means
  - (b) Stealing or misusing chemicals with malicious intent
  - (c) Contaminating or spoiling products
  - (d) Destroying or despoiling assets

Consequences of these threats include the following:

- (1) Immediate consequences:
  - (a) Release of materials — quantity and rate
  - (b) Downwind effects:
    - i. Concentration versus distance for toxic materials and flammable materials
    - ii. Thermal effects from ignition of a flammable vapor cloud
    - iii. Overpressure effects from an explosion
    - iv. Impact on surrounding areas
- (2) Fatalities or injuries to personnel or the public
- (3) Disruption of operations, both private and public
- (4) Adverse media coverage
- (5) Environmental damage
- (6) Financial loss
- (7) Loss of critical data
- (8) Damage to corporate reputation or ability to continue operations

**G.5 Assess Physical Factors/Attractiveness.** Such assessment includes:

- (1) Extent of property damage
- (2) Disruption to operations
- (3) Damage to critical infrastructure
- (4) Effect on company's reputation
- (5) Proximity to national symbols or structures
- (6) Effect on local, regional, or national economy or infrastructure
- (7) Attack on target of high representative value (monuments, etc.)
- (8) Accessibility
- (9) Media interest
- (10) Potential target list
- (11) General level of hazard
- (12) Specific value as a target
- (13) Specific reason for value as a target
- (14) Specific security needs for target
- (15) Identification of adversary as one of the following:
  - (a) Terrorist
  - (b) Criminal
  - (c) Violent activist
  - (d) Deranged individual
  - (e) Disgruntled employee
- (16) Characteristics of adversary:
  - (a) Is willing to die
  - (b) Has a desire for maximum damage and casualties
  - (c) Inflicts psychological terror on the population
  - (d) Creates an inability of the government to protect citizenry
- (17) Capabilities of adversary:
  - (a) Is highly trained
  - (b) Has the ability to use weapons, explosives, and/or incendiaries
  - (c) Has the ability to develop improvised explosives and incendiaries
  - (d) Is capable of deception using fake identification

**G.6 Identify Mitigation Factors.** This process involves the following:

- (1) A scenario-based analysis
  - (a) Brainstorming sessions
  - (b) Selection of types of adversary
  - (c) Evaluation of the likelihood of success of security to be able to:
    - i. Deter
    - ii. Detect
    - iii. Delay
- (2) An asset-based risk ranking, which identifies the following:
  - (a) High vulnerability sites — security plan must be effective for use by trained personnel with limited resources.
  - (b) Medium vulnerability sites — security plan must be effective for use by untrained personnel with limited resources.
  - (c) Low vulnerability sites — security plan must be effective for use to deter criminal acts.

**G.7 Conduct Security Assessment or Gap Analysis.** The following should be taken into consideration:

- (1) No single approach to assessing vulnerability or implementing security
- (2) Multidisciplinary approach for assessment/gap analysis
- (3) Environmental health and safety
- (4) Process safety engineering
- (5) Process operators



## Annex H Sample Ordinance Adopting NFPA 30

*This annex is not a part of the requirements of this NFPA document but is included for informational purposes only.*

**H.1** The following sample ordinance is provided to assist a jurisdiction in the adoption of this code and is not part of this code.

ORDINANCE NO. \_\_\_\_\_

An ordinance of the [jurisdiction] adopting the [year] edition of NFPA [document number], [complete document title], and documents listed in Chapter 2 of that [code, standard]; prescribing regulations governing conditions hazardous to life and property from fire or explosion; providing for the issuance of permits and collection of fees; repealing Ordinance No. \_\_\_\_\_ of the [jurisdiction] and all other ordinances and parts of ordinances in conflict therewith; providing a penalty; providing a severability clause; and providing for publication; and providing an effective date.

BE IT ORDAINED BY THE [governing body] OF THE [jurisdiction]:

SECTION 1 That the [complete document title] and documents adopted by Chapter 2, three (3) copies of which are on file and are open to inspection by the public in the office of the [jurisdiction's keeper of records] of the [jurisdiction], are hereby adopted and incorporated into this ordinance as fully as if set out at length herein, and from the date on which this ordinance shall take effect, the provisions thereof shall be controlling within the limits of the [jurisdiction]. The same are hereby adopted as the [code, standard] of the [jurisdiction] for the purpose of prescribing regulations governing conditions hazardous to life and property from fire or explosion and providing for issuance of permits and collection of fees.

SECTION 2 Any person who shall violate any provision of this code or standard hereby adopted or fail to comply therewith; or who shall violate or fail to comply with any order made thereunder; or who shall build in violation of any detailed statement of specifications or plans submitted and approved thereunder; or fail to operate in accordance with any certificate or permit issued thereunder; and from which no appeal has been taken; or who shall fail to comply with such an order as affirmed or modified by a court of competent jurisdiction, within the time fixed herein, shall severally for each and every such violation and noncompliance, respectively, be guilty of a misdemeanor, punishable by a fine of not less than \$ \_\_\_\_\_ nor more than \$ \_\_\_\_\_ or by imprisonment for not less than \_\_\_\_\_ days nor more than \_\_\_\_\_ days or by both such fine and imprisonment. The imposition of one penalty for any violation shall not excuse the violation or permit it to continue; and all such persons shall be required to correct or remedy such violations or defects within a reasonable time; and when not otherwise specified the application of the above penalty shall not be held to prevent the enforced removal of prohibited conditions. Each day that prohibited conditions are maintained shall constitute a separate offense.

SECTION 3 Additions, insertions, and changes — that the [year] edition of NFPA [document number], [complete document title] is amended and changed in the following respects:

List Amendments

SECTION 4 That ordinance No. \_\_\_\_\_ of [jurisdiction] entitled [fill in the title of the ordinance or ordinances in effect at the present time] and all other ordinances or parts of ordinances in conflict herewith are hereby repealed.

SECTION 5 That if any section, subsection, sentence, clause, or phrase of this ordinance is, for any reason, held to

be invalid or unconstitutional, such decision shall not affect the validity or constitutionality of the remaining portions of this ordinance. The [governing body] hereby declares that it would have passed this ordinance, and each section, subsection, clause, or phrase hereof, irrespective of the fact that any one or more sections, subsections, sentences, clauses, and phrases be declared unconstitutional.

SECTION 6 That the [jurisdiction's keeper of records] is hereby ordered and directed to cause this ordinance to be published.

[NOTE: An additional provision may be required to direct the number of times the ordinance is to be published and to specify that it is to be in a newspaper in general circulation. Posting may also be required.]

SECTION 7 That this ordinance and the rules, regulations, provisions, requirements, orders, and matters established and adopted hereby shall take effect and be in full force and effect [time period] from and after the date of its final passage and adoption.

## Annex I Informational References

**I.1 Referenced Publications.** The documents or portions thereof listed in this annex are referenced within the informational sections of this code and are not part of the requirements of this document unless also listed in Chapter 2 for other reasons.

**I.1.1 NFPA Publications.** National Fire Protection Association, 1 Batterymarch Park, Quincy, MA 02169-7471.

NFPA 1, *Fire Code*, 2015 edition.

NFPA 10, *Standard for Portable Fire Extinguishers*, 2013 edition.

NFPA 11, *Standard for Low-, Medium-, and High-Expansion Foam*, 2010 edition.

NFPA 13, *Standard for the Installation of Sprinkler Systems*, 2013 edition.

NFPA 14, *Standard for the Installation of Standpipe and Hose Systems*, 2013 edition.

NFPA 15, *Standard for Water Spray Fixed Systems for Fire Protection*, 2012 edition.

NFPA 16, *Standard for the Installation of Foam-Water Sprinkler and Foam-Water Spray Systems*, 2011 edition.

NFPA 24, *Standard for the Installation of Private Fire Service Mains and Their Appurtenances*, 2013 edition.

NFPA 25, *Standard for the Inspection, Testing, and Maintenance of Water-Based Fire Protection Systems*, 2014 edition.

NFPA 30, *Flammable and Combustible Liquids Code*, 1993 edition.

NFPA 30B, *Code for the Manufacture and Storage of Aerosol Products*, 2015 edition.

NFPA 31, *Standard for the Installation of Oil-Burning Equipment*, 2011 edition.

NFPA 51B, *Standard for Fire Prevention During Welding, Cutting, and Other Hot Work*, 2014 edition.

NFPA 58, *Liquefied Petroleum Gas Code*, 2014 edition.

NFPA 68, *Standard on Explosion Protection by Deflagration Venting*, 2013 edition.

NFPA 69, *Standard on Explosion Prevention Systems*, 2014 edition.

NFPA 70®, *National Electrical Code*®, 2014 edition.

NFPA 72, *National Fire Alarm and Signaling Code*, 2013 edition.

NFPA 77, *Recommended Practice on Static Electricity*, 2014 edition.

NFPA 90A, *Standard for the Installation of Air-Conditioning and Ventilating Systems*, 2015 edition.

NFPA 91, *Standard for Exhaust Systems for Air Conveying of Vapors, Gases, Mists, and Noncombustible Particulate Solids*, 2010 edition.

NFPA 101<sup>®</sup>, *Life Safety Code*<sup>®</sup>, 2015 edition.

NFPA 204, *Standard for Smoke and Heat Venting*, 2012 edition.

NFPA 220, *Standard on Types of Building Construction*, 2015 edition.

NFPA 306, *Standard for the Control of Gas Hazards on Vessels*, 2014 edition.

NFPA 326, *Standard for the Safeguarding of Tanks and Containers for Entry, Cleaning, or Repair*, 2010 edition.

NFPA 329, *Recommended Practice for Handling Releases of Flammable and Combustible Liquids and Gases*, 2010 edition.

NFPA 385, *Standard for Tank Vehicles for Flammable and Combustible Liquids*, 2012 edition.

NFPA 496, *Standard for Purged and Pressurized Enclosures for Electrical Equipment*, 2013 edition.

NFPA 497, *Recommended Practice for the Classification of Flammable Liquids, Gases, or Vapors and of Hazardous (Classified) Locations for Electrical Installations in Chemical Process Areas*, 2012 edition.

NFPA 505, *Fire Safety Standard for Powered Industrial Trucks Including Type Designations, Areas of Use, Conversions, Maintenance, and Operations*, 2013 edition.

NFPA 551, *Guide for the Evaluation of Fire Risk Assessments*, 2013 edition.

NFPA 704, *Standard System for the Identification of the Hazards of Materials for Emergency Response*, 2012 edition.

NFPA 730, *Guide for Premises Security*, 2014 edition.

NFPA 5000<sup>®</sup>, *Building Construction and Safety Code*<sup>®</sup>, 2015 edition.

*Fire Protection Guide to Hazardous Materials*, 2010.

*Flammable and Combustible Liquids Code Handbook*, 2012.

Hall, John R., Jr., Ph.D., "A Fire Risk Analysis Model for Assessing Options for Flammable and Combustible Liquid Products in Storage and Retail Occupancies," *Fire Technology*, Vol. 31, No. 4, November 1995, pp. 291-306.

## I.1.2 Other Publications.

**I.1.2.1 ACC Publications.** American Chemistry Council, 700 Second Street, N.E., Washington DC 20002.

*Implementation Resource Guide for Responsible Care Security Code of Management Practices: Value Chain Activities*, 2002.

*Site Security Guidelines for the U.S. Chemical Industry*, 2001.

*Transportation Security Guidelines for the U.S. Chemical Industry*, 2001.

**I.1.2.2 AIChE Publications.** American Institute of Chemical Engineers, 3 Park Avenue, New York, NY 10016.

Fisher, H.G., and Forrest, H.S., "Protection of Storage Tanks from Two-Phase Flow Due to Fire Exposure," *Process Safety Progress*, Vol. 14, July 1995, pp. 183-199.

*Guidelines for Analyzing and Managing the Security Vulnerabilities of Fixed Chemical Sites*, 2003.

*Guidelines for Chemical Process Quantitative Risk Analysis*, 2nd edition, 1999.

*Guidelines for Evaluating Process Plant Buildings for External Explosions and Fires*, 1996.

*Guidelines for Pressure Relief and Effluent Handling Systems*, 1998.

*Guidelines for Vapor Cloud Explosion, Pressure Vessel Burst, BLEVE and Flash Fire Hazards*, 2nd edition, 2011.

Houser, J., et. al, "Vent Sizing for Fire Considerations: External Fire Duration, Jacketed Vessels, and Heat Flux Variations Owing to Fuel Consumption," *Journal of Loss Prevention in the Process Industries*, Vol. 14 No. 5, September 2001, pp. 403-412.

Nugent, D.P., Freeman, J.L., and Oliszewicz, M.P., *Guidelines for Safe Warehousing of Chemicals*, 1998.

**I.1.2.3 ANSI Publications.** American National Standards Institute, Inc., 25 West 43rd Street, 4th Floor, New York, NY 10036.

ANSI Z129.1, *Hazardous Industrial Chemicals—Precautionary Labeling*, 2005.

ANSI Z535.2, *Environmental and Facility Safety Signs*, 2011.

**I.1.2.4 API Publications.** American Petroleum Institute, 1220 L Street, NW, Washington, DC 20005.

API RP 70, *Security for Offshore Oil and Natural Gas Operations*, 1st edition, 2003.

API RP 70I, *Security for Worldwide Offshore Oil and Natural Gas Operations*, 2004.

API 12R1, *Setting, Maintenance, Inspection, Operation, and Repair of Tanks in Production Service*, 2008.

API RP 500, *Recommended Practice for Classification of Locations for Electrical Installations at Petroleum Facilities Classified as Class I, Division 1 and Division 2*, Revision 2, 1998.

API RP 505, *Recommended Practice for Classification of Locations for Electrical Installations at Petroleum Facilities Classified as Class I, Zone 0, Zone 1, and Zone 2*, 2002.

API 620, *Recommended Rules for the Design and Construction of Large, Welded, Low-Pressure Storage Tanks*, 11th edition, 2012.

API Standard 650, *Welded Steel Tanks for Oil Storage*, 11th edition, 2011.

API 653, *Tank Inspection, Repair, Alteration, and Reconstruction*, 4th edition, 2012.

API RP 752, *Management of Hazards Associated with Location of Process Plant Buildings*, 3rd edition, 2009.

API RP 753, *Management of Hazards Associated with Location of Process Plant Portable Buildings*, 1st edition, 2007 (R2012).

API Standard 1164, *SCADA Security*, Edition 2, 2009.

API 1501, *Filtration and Dehydration of Aviation Fuels*, 1st edition, 1965.

API 1604, *Removal and Disposal of Used Underground Petroleum Storage Tanks*, 3rd edition, reaffirmed 2001.

API RP 1615, *Installation of Underground Petroleum Storage Systems*, 6th edition, 2011.

API RP 1621, *Bulk Liquid Stock Control at Retail Outlets*, 2001.

API 1631, *Interior Lining of Underground Storage Tanks*, 5th edition, reaffirmed 2010.

API RP 1632, *Cathodic Protection of Underground Petroleum Storage Tanks and Piping Systems*, 3rd edition, reaffirmed 2010.

API 2003, *Protection Against Ignition Arising Out of Static, Lightning, and Stray Currents*, 7th edition, 2008.

API 2015, *Cleaning Petroleum Storage Tanks*, 6th edition, reaffirmed 2006.

API 2016, *Guidelines and Procedures for Entering and Cleaning Petroleum Storage Tanks*, 1st edition, reaffirmed 2006.

API 2214, *Spark Ignition Properties of Hand Tools*, 4th edition, 2004.



API 2217A, *Guidelines for Work in Inert Confined Spaces in the Petroleum Industry*, 4th edition, 2009.

API 2218, *Fireproofing Practices in Petroleum and Petrochemical Processing Plants*, 2nd edition, 1999.

API 2219, *Safe Operating Guidelines for Vacuum Trucks in Petroleum Service*, 3rd edition, 2005.

API 2350, *Overfill Protection for Storage Tanks in Petroleum Facilities*, 4th edition, 2012.

API Security Guidelines for the Petroleum Industry, 3rd edition, 2005.

API Standard 2610, *Design, Construction, Operation, Maintenance, and Inspection of Terminal and Tank Facilities*, 2nd edition, 2005.

“An Engineering Analysis of the Effects of Oxygenated Fuels on Marketing Vapor Recovery Equipment,” September 1990.

API 4589, *Fugitive Hydrocarbon Emissions from Petroleum Production Operations*, 1993.

API/National Petrochemical and Refiners Association, *Security Vulnerability Assessment Methodology*, 2nd edition, 2004.

**I.1.2.5 Association of Canadian Distillers Publications.** Association of Canadian Distillers, Suite 518, 90 Rue Sparks, Ottawa, Ontario, K1P 5B4, Canada.

“Fire Tests of Distilled Spirits Storage Tanks,” Client Report CR-5727.1, 2001.

**I.1.2.6 ASTM Publications.** ASTM International, 100 Barr Harbor Drive, P.O. Box C700, West Conshohocken, PA 19428-2959.

ASTM C 1055, *Standard Guide for Heated System Surface Conditions that Produce Contact Burn Injuries*, 2003 (Reaffirmed 2009).

ASTM D 4206, *Standard Test Method for Sustained Burning of Liquid Mixtures Using the Small Scale Open-Cup Apparatus*, 1996 (reaffirmed 2007).

ASTM D 4207, *Standard Test Method for Sustained Burning of Low Viscosity Liquid Mixtures by the Wick Test*, 1991.

ASTM D 4956, *Standard Specification for Retroreflective Sheeting for Traffic Control*, 2011a.

ASTM D 6469, *Standard Guide for Microbial Contamination in Fuels and Fuel Systems*, 2012.

ASTM E 119, *Standard Test Methods for Fire Tests of Building Construction and Materials*, 2012 a.

ASTM E 502, *Standard Test Method for Selection and Use of ASTM Standards for the Determination of Flash Point of Chemicals by Closed Cup Methods*, 2007 e1.

ASTM Manual on Flash Point Standards and Their Use, 1992.

**I.1.2.7 ISO Publications.** International Organization for Standardization, 1, ch. de la Voie-Creuse, Case postale 56, CH-1211 Geneva 20, Switzerland.

ISO 13732-1, *Ergonomics of the Thermal Environment — Methods for the Assessment of Human Responses to Contact with Surfaces Part 1: Hot Surfaces*, 2006 edition.

**I.1.2.8 NACE Publications.** National Association of Corrosion Engineers, 1440 South Creek Drive, Houston, TX 77084.

NACE RP-0169, *Recommended Practice, Control of External Corrosion on Underground or Submerged Metallic Piping Systems*, 1996.

NACE RP-0285, *Recommended Practice, Corrosion Control of Underground Storage Tank Systems by Cathodic Protection*, 2002.

**I.1.2.9 NEIWPCC Publications.** New England Interstate Water Pollution Control Commission, 85 Merrimac Street, Boston, MA 02114.

*Tank Closure Without Tears: An Inspector's Safety Guide*, May 1988.

**I.1.2.10 NIOSH Publications.** National Institute for Occupational Safety and Health, Centers for Disease Control and Prevention, 1600 Clifton Road, Atlanta, GA 30333.

*Criteria for Recommended Standard for Working in Confined Spaces*, 1979.

NIOSH 87-113, *A Guide to Safety in Confined Spaces*, 1987.

**I.1.2.11 NORA Publications.** National Oilheat Research Alliance, 600 Cameron Street, Suite 600, Alexandria, VA 22314.

*Oilheat Technician's Manual*, 2002.

**I.1.2.12 Oil and Gas Journal Publications.** PennWell Publishing Co., 3050 Post Oak Boulevard, Houston, TX 77056.

“Module Ventilation Rates Quantified,” W. E. Gale, December 23, 1985, p. 41.

**I.1.2.13 PEI Publications.** Petroleum Equipment Institute, P.O. Box 2380, Tulsa, OK 74101-2380.

PEI RP100, *Recommended Practices for Installation of Underground Liquid Storage Systems*, 2011.

PEI RP200, *Recommended Practices for Installation of Aboveground Storage Systems for Motor Vehicle Fueling*, 2008.

PEI RP600, *Recommended Practices for Overfill Prevention for Shop-Fabricated Aboveground Tanks*, 2012.

**I.1.2.14 SFPE Publications.** Society of Fire Protection Engineers, 7315 Wisconsin Avenue, Suite 1225 W, Bethesda, MD 20814.

*Directory of Fire Tests Involving Storage of Flammable and Combustible Liquids in Small Containers*, 3rd edition, by David P. Nugent, Schirmer Engineering Corporation, 2006.

*Engineering Guide: Assessing Flame Radiation to External Targets from Pool Fires*, 1999.

*Engineering Guide: Predicting 1st and 2nd Degree Skin Burns from Thermal Radiation*, 2000.

*Engineering Guide to Fire Exposures to Structural Elements*, 2004.

*Engineering Standard on Calculating Fire Exposures to Structures*, 2010.

*Handbook of Fire Protection Engineering*, 2008.

**I.1.2.15 STI Publications.** Steel Tank Institute, 570 Oakwood Road, Lake Zurich, IL 60047.

SP001, *Standard for Inspection of Aboveground Storage Tanks*, 5th edition, 2011.

STI-P3, *Specification and Manual for External Corrosion Protection of Underground Steel Storage Tanks*, 2012.

STI R931, *Double Wall AST Installation and Testing Instructions*, 2012.

STI RP 892, *Recommended Practice for Corrosion Protection of Underground Piping Networks Associated with Liquid Storage and Dispensing Systems*, 2012.

STI RP R011, *Recommended Practice for Anchoring of Steel Underground Storage Tanks*, 2006.

STI, ACT-100®, *Specification for External Corrosion Protection of FRP Composite Steel Underground Tanks*, F894, 1997.

*Keeping Water Out of Your Storage System*, 2004.



**I.1.2.16 UL Publications.** Underwriters Laboratories Inc., 333 Pfingsten Road, Northbrook, IL 60062-2096.

ANSI/UL 30, *Standard for Metal Safety Cans*, 1995, Revised 2009.

ANSI/UL 142, *Standard for Steel Aboveground Tanks for Flammable and Combustible Liquids*, 2006, Revised 2010.

ANSI/UL 263, *Standard for Fire Tests of Building Construction and Materials*, 2011.

ANSI/UL 1313, *Standard for Nonmetallic Safety Cans for Petroleum Products*, 2005, Revised 2007.

UL 1316, *Standard for Glass-Fiber-Reinforced Plastic Underground Storage Tanks for Petroleum Products, Alcohols, and Alcohol-Gasoline Mixtures*, 1994, Revised 2006.

ANSI/UL 1709, *Standard for Rapid Rise Fire Tests of Protection Materials for Structural Steel*, 2005, Revised 2011.

ANSI/UL 1746, *Standard for External Corrosion Protection Systems for Steel Underground Storage Tanks*, 2007.

**I.1.2.17 ULC Publications.** Underwriters Laboratories of Canada, 7 Underwriters Road, Scarborough, Ontario M1R 3B4, Canada.

CAN/ULC-S603.1, *Standard for External Corrosion Protection Systems for Steel Underground Tanks for Flammable and Combustible Liquids*, 2011.

**I.1.2.18 UN Publications.** United Nations Publications, 2 United Nations Plaza, Room DC2-853, New York, NY 10017.

*Recommendations on the Transport of Dangerous Goods, 17th revised edition, 2011.*

**I.1.2.19 U.S. Government Publications.** U.S. Government Printing Office, Washington, DC 20402.

DOT, Office of Pipeline Safety, Pipeline Security Information Circular, Information of Concern to Pipeline Security Personnel, *Security Guidance for Natural Gas, and Hazardous Liquid Pipelines and Liquefied Natural Gas Facilities*, September 5, 2002.

U.S. Coast Guard NVIC 11-02 and other NVICs

*EPA Protocols for Generating Unit-Specific Emission Estimates for Equipment Leaks of VOC and HAP*, 1987 (Document No. 87-222-124-10-02).

*EPA/Radian Study*, 1979.

Occupational Health & Safety Administration (OSHA) 2226, *Excavation & Trenching Operations*, 1990.

Title 21, Code of Federal Regulations, Part 800-898, "GMP for Medical Devices."

Title 29, Code of Federal Regulations, Part 1910.106, "Flammable and Combustible Liquids."

Title 29, Code of Federal Regulations, Part 1910.1200, "Hazard Communication."

Title 33, Code of Federal Regulations, Parts 154-156, "Navigation and Navigable Waterways."

Title 40, Code of Federal Regulations, Part 280, "Technical Standards and Requirements for Owners and Operators of Underground Storage Tanks."

Title 49, Code of Federal Regulations, Parts 100-199, "Hazardous Materials Transportation."

**I.1.2.20 Other Publications.** Sandia National Laboratories, "Vulnerability Assessment Methodology for Chemical Facilities (VAM-CF)"

**I.1.3 References for Annex E.** The following documents or portions thereof are listed here as informational resources only. They are not a part of the requirements of this document.

Gewain, R. G., "Fire Protection of Aerosol Products," *Southern Building Magazine*, September/October, 1996, pp. 10-12.

Hill, J. P., "International Foam-Water Sprinkler Research Project: Task 3 — Range Finding Tests," Factory Mutual Research Report J.I. OTOR6.RR, prepared for the National Fire Protection Research Foundation, Norwood, MA, July 1991.

Newman, R. M., Fitzgerald, P. M., and Young, J. R., "Fire Protection of Drum Storage Using 'Light Water' Brand AFFF in a Closed-Head Sprinkler System," Factory Mutual Research Corporation Report FMRC Ser. No. 22464, RC75-T-16, Norwood, MA, March 1975.

Nugent, D. P., "Fire Tests Involving Storage of Flammable and Combustible Liquids in Small Containers," *Journal of Fire Protection Engineering* 6(1):1994; 1-10.

Young, J. K., and Fitzgerald, P. M., "The Feasibility of Using 'Light Water' Brand AFFF in a Closed-Head Sprinkler System for Protection Against Flammable Liquid Spill Fires," Factory Mutual Research Report FMRC Ser. No. 22352, RC75-T-4, Norwood, MA, January 1975.

**I.2 Informational References.** The following documents or portions thereof are listed here as informational resources only. They are not a part of the requirements of this document.

Allahdadi, F. A., Luehr, C., Morehouse, T., and Campbell, P., "Modeling Response of Tanks Containing Flammables to Fire Impingement," ESL-TR-87-53, Engineering and Services Laboratory, Tyndall AFB, FL, July 1988.

American Petroleum Institute, API 2000, "Venting Atmospheric and Low Pressure Storage Tanks," API, Washington, DC, 1982.

Bainbridge, B. L., and Keltner, N. R., "Heat Transfer to Large Objects in Large Pool Fires," SAND-87-0641C, Sandia National Laboratories, Albuquerque, NM, 1987.

Birk, A. M., "Modeling the Effects of a Torch-Type Fire Impingement on a Rail or Highway Tanker," *Fire Safety Journal*, 15 (1989): 277-296.

Committee on Hazardous Materials, Division of Chemistry and Chemical Technology, National Research Council (ed.), *Pressure-Relieving Systems for Marine Cargo Bulk Liquid Containers*, National Academy of Sciences, Washington, DC, 1973.

Factory Mutual Laboratories, Research Project No. 11365, November 2, 1949, "Fire Tests of Vent Fittings for Paint Drums," Laboratory Report No. 13604, February 1958; 26.

Hall, J. R., Gandhi, P. D., and Sheppard, D. T., *Fire Risk Analysis for Flammable and Combustible Liquid Project — Containers in Storage and Retail Occupancies*, National Fire Protection Research Foundation, Quincy, MA, February, 1994.

Hall, J. R., "A Fire Risk Analysis Model for Assessing Options for Flammable and Combustible Liquid Products in Storage and Retail Occupancies," *Fire Technology*, Vol. 31, No. 4, 1995, pp. 291-306.

Houser, J., et al., "Vent Sizing for Fire Considerations: External Fire Duration, Jacketed Vessels, and Heat Flux Variations Owing to Fuel Consumption," *Journal of Loss Prevention in the Process Industries*, 14 (1998): 403-412.

Johnson, M. R., "Temperatures, Pressures and Liquid Levels of Tank Cars Engulfed in Fires — Volume I, Results of Parametric Analyses," DOT/FRA/OR&D-84/08.11, Federal Railroad Administration, Washington, DC, June 1984.



McLain, W. H., "Investigation of the Fire Safety Characteristics of Portable Tanks — Polyethylene Tanks Containing Flammable Liquids," Report No. CG-M-1-88, U.S. Coast Guard Marine Technical and Hazardous Materials Division, Avery Point, CT, March 1988.

Nugent, D. P., Freeman, J. L., and Oliszewicz, M. P., *Guidelines for Safe Warehousing of Chemicals*, Center for Chemical Process Safety, American Institute of Chemical Engineers, New York NY, 1998, pp. 113–119.

Richards, R. C., and White, K. T., "Fire Exposure Tests of Polyethylene and 55 Gallon Steel Drums Loaded with Flammable Liquids, Phase I," Report No. CG-D-116-76, Department of Transportation, U.S. Coast Guard, Washington, DC, September 1976.

Richards, R. C., and Munkenbeck, G. J., "Fire Exposure Tests of Polyethylene and 55 Gallon Steel Drums Loaded with Flammable Liquids, Phase II," Report No. CG-D-86-77, Department of Transportation, U.S. Coast Guard, Washington, DC, August 1977.

Rogerson, J. E., "Flammable and Combustible Liquid Drum Storage Problems," American Institute of Chemical Engineers Summer National Meeting Progress, Paper No. 63, 1981.

Russell, L. H., and Canfield, J. A., "Experimental Measurement of Heat Transfer to a Cylinder Immersed in a Large Aviation Fuel Fire," *Journal of Heat Transfer*, August 1973.

Scheffey, J. L., *International Intermediate Bulk Container Fire Test Project — Scoping Tests*, National Fire Protection Research Foundation, Quincy, MA, September 1996.

Scheffey, J. L., Sheppard, D. T., and Stepan, D., *International Intermediate Bulk Container Fire Test Project — Required Delivered Density Tests*, National Fire Protection Research Foundation, Quincy, MA, April 1997.

Scheffey, J. L., Pabich, M., and Sheppard, D. T., *International Intermediate Bulk Container Fire Test Project — Phase IIA — Evaluation of Large Arrays*, National Fire Protection Research Foundation, Quincy, MA, April 1998.

Scheffey, J. L., Pabich, M., and Sheppard, D. T., *International Intermediate Bulk Container Fire Test Project — Phase IIB — Verification Tests and Development of Standardized Evaluation*, Na-

tional Fire Protection Research Foundation, Quincy MA, April, 1998.

Schemel, S. D., et al., "Methodology for Determining Reliability of a Foam Suppression System Using Fuzzy Set Theory and Fault Tree Analysis," *Proceedings of the International Conference and Workshop on Reliability and Risk Management*, Center for Chemical Process Safety, American Institute of Chemical Engineers, 1998.

Silicone Products Department of General Electric, "Bulging and Rupture Characteristics of 55-Gallon, Steel Closed-Top Drums at Known Pressure," Company Report No. R-65-Ch-SD-529, September 30, 1965.

Sumitra, P. S. and Troup, J. M. A., "The Effect on Sprinkler Protection of Using Thin Pallets for Palletized Barreled Whiskey Storage," FMRC J.I. OEOR1.RR, RC 79-T-60, March 1980.

Sumitra, P. S. and Troup, J. M. A., "Fire Protection Requirements for Six-Barrel High Palletized Storage of Distilled Spirits," FMRC J.I. OC2R6.RR, RC 78-T-42, February 1979.

Sumitra P. S. and Troup, J. M. A., "The Protection Requirements for Six-Barrel High Palletized Storage of Distilled Spirits, Phase II," FMRC J.I. OEOR1.RR, RC 79-T-66, November 1979.

Tavares, R. and Delichatsios, M. A., "Pressure Relief in Flammable-Liquid Drums by Pressure-Activated and Plastic Bunds," FMRC J.I. OFOR4.RA 070(A), Factory Mutual Research Corporation, Norwood, MA, March 1981.

Technical Report on Storage of Palletized Isopropyl Alcohol, Project 96NK33044/NC1838, Prepared for HSB Industrial Risk Insurers, Underwriters Laboratories, Inc., Northbrook, IL, April 18, 1997.

Technical Report of Running Alcohol Fuel Fires Within Rack Storage of Plastic Drums, Project NC183897NK31221, Revised Draft, Underwriters Laboratories Inc., Northbrook, IL, July 15, 1998.

Yao, C., "Flammable Liquid Drum Fire Protection System Development," FMRC Report No. 16425, prepared for the Manufacturing Chemists Association, Norwood, MA, May 5, 1967.

### I.3 References for Extracts in Informational Sections.

NFPA 307, *Standard for the Construction and Fire Protection of Marine Terminals, Piers, and Wharves*, 2011 edition.

## Index

Copyright © 2014 National Fire Protection Association. All Rights Reserved.

The copyright in this index is separate and distinct from the copyright in the document that it indexes. The licensing provisions set forth for the document are not applicable to this index. This index may not be reproduced in whole or in part by any means without the express written permission of NFPA.

- A-**
- Aboveground storage tanks** ..... Chap. 22; *see also* Atmospheric tanks
- Abandonment, closure, or removal ..... 21.7.4.1, 21.7.4.2
  - Collision protection ..... 22.11.3.9, 22.11.4.7, 22.15
  - Combustible materials, constructed of ..... 21.4.1.2(3)
  - Definition ..... 3.3.51.1
  - Electrical area classification ..... 7.3.3
  - Fill pipes ..... 21.4.4, A.21.4.4
  - Fire-resistant ..... 22.9
    - Definition ..... 22.2.1
  - Flooding, in areas subject to ..... 22.14
  - Identification, hazard ..... 21.7.2.2, A.21.7.2.2
  - Impounding ..... 22.11.1, 22.11.2, 22.12, A.22.11.2.2 to A.22.11.2.6.3.4, A.22.12.1, A.22.12.3
  - Inspection and maintenance ..... 22.17, A.22.17.4, A.25.3.1
  - Installation ..... 22.5, 22.16, A.22.5.2.1, A.22.5.2.4
  - Location ..... 22.4, A.22.4
  - Openings (non-vent) ..... 22.13
  - Overfilling, prevention of ..... 21.7.1, A.21.7.1
  - Protected ..... 22.10
    - Definition ..... 22.2.3
  - Reuse ..... 21.7.4.2
  - Spacing between adjacent ..... 22.4.1.7, 22.4.2, 22.11.4.6, A.22.4.2.1
  - Spillage control ..... 22.11, A.22.11
  - Supports, foundations, and anchorage ..... 22.5.1, 22.5.2, A.22.5.2.1, A.22.5.2.4
  - Testing ..... 21.5.2, A.21.5.2
  - Underground use prohibited ..... 21.3.3
  - Vaults; ..... *see* Vaults
  - Venting ..... 22.6, 22.7, 22.9.2, 22.10.2, 22.11.3.12, 22.11.4.8, 27.8.1, A.22.7.3.1 to A.22.7.4, A.27.8.1.6, Annex B
- Access**
- Hazardous materials storage lockers ..... 14.5.5, 14.6.4
  - Heat transfer system piping ..... 19.4.5.3.3
  - Inside liquid storage areas ..... 9.9.3
  - Isolation valve, loading piping ..... 27.6.7
  - Outdoor storage ..... 15.3.8
  - Process units or buildings ..... 17.5
  - Storage tank buildings ..... 24.4.8, 24.5.6, A.24.5.6
  - Storage tanks, aboveground ..... 22.11.3.3
- Accidental release of liquids or vapors** ..... 17.14, A.17.14
- Aerosol products** ..... 1.1.2(5), 9.17.2, A.1.1.2(5)
- Alarms**
- Liquid processing operations ..... 6.6, A.6.6.2
  - Storage tank buildings ..... 24.15
  - Vaults ..... 25.15
- Alcohol-based hand rub**
- Definition ..... 3.3.1
  - Dispensers ..... 1.1.2(9), A.1.1.2(9)
- Ambulatory health care occupancies**
- Definition ..... 3.3.39.1
  - Maximum allowable quantities per control area ..... 9.6.2.1, 9.6.2.2, 9.6.2.4
- Application of code** ..... 1.1.1, 1.1.2, 1.3, A.1.1.1 to A.1.1.2(9)
- Approved (definition)** ..... 3.2.1, A.3.2.1
- Area** ..... *see also* Control areas; Inside liquid storage areas
- Fire area (definition) ..... 3.3.2.2
- Assembly occupancies**
- Definition ..... 3.3.39.2
  - Maximum allowable quantities per control area ..... 9.6.2.1, 9.6.2.2
- Atmospheric tanks** ..... 21.4.2.1, A.21.4.2.1.1
- Definition ..... 3.3.51.2, A.3.3.51.2
- Extinguishing system ..... 22.8.1, A.22.8.1
  - Overfilling, prevention of ..... 21.7.1.6
  - Storage tanks, venting of ..... 21.4.3.10
  - Venting ..... 21.4.3.4
- Authority having jurisdiction**
- Approval of hazardous materials storage sites ..... 14.5.1, 14.5.3
  - Definition ..... 3.2.2, A.3.2.2
- Automatic sprinkler systems** ..... *see* Sprinkler systems
- B-**
- Barrels (definition)** ..... 3.3.3
- Basements** ..... 24.5.3, 24.9.5
- Below grade control areas ..... 9.7.2, 9.7.3
  - Class I liquids processing prohibited in ..... 17.6.9
  - Containers and portable tank storage in ..... 9.3.6 to 9.3.8
  - Definition ..... 3.3.4
  - Mercantile occupancies ..... 10.8.2
  - Solvent distillation units prohibited in ..... 19.6.4.2
  - Tank storage in ..... 24.4.9
- Below grade control areas** ..... 9.7.2, 9.7.3
- Boiling point**
- Atmospheric tanks, storage of liquids in ..... 21.4.2.1.6
  - Definition ..... 3.3.5, 4.2.1, A.4.2.1
- Boil-over** ..... 22.4.1.4
- Definition ..... 3.3.6, A.3.3.6
- Bonding** ..... 6.5.4.2, 6.5.4.3; *see also* Static electricity protection
- Definition ..... 3.3.7
  - Loading and unloading facilities ..... 28.3.1, 28.11.1.2, A.28.3.1.2, A.28.11.3
  - Piping systems ..... 27.9
  - Wharves ..... 29.3.12
- Building code (definition)** ..... 3.3.9
- Buildings** ..... *see also* Storage tank buildings
- Definition ..... 3.3.8
  - Detached, unprotected buildings, storage in ..... Chap. 13
  - Important
    - Definition ..... 3.3.8.1, A.3.3.8.1
    - Tank location and ..... 22.4.1
    - Outdoor storage adjacent to ..... 15.4
- Bulk containers** ..... *see* Aboveground storage tanks; Intermediate bulk containers (IBCs); Storage tanks
- Bulk loading/unloading for tank cars/vehicles** ..... Chap. 28
- Business occupancies**
- Definition ..... 3.3.39.3
  - Detached buildings, separation of ..... 13.3.1, 13.3.2, A.13.3.1, A.13.3.2
  - Maximum allowable quantities per control area ..... 9.6.2.1, 9.6.2.2
- C-**
- Cabinets, storage** ..... *see* Storage cabinets
- Ceiling sprinklers** .. 16.5.1.4, 16.6.1.6 to 16.6.1.9, 16.6.2.6 to 16.6.2.8, 16.6.3.5 to 16.6.3.7
- Change, management of** ..... 6.4.2
- Check valves** ..... 27.6.6.3, 27.6.7
- Chemical plants (definition)** ..... 3.3.10
- Chemicals**
- Hazardous ..... *see also* Hazardous materials storage lockers
  - Definition ..... 3.3.24, A.3.3.24
  - Hazardous chemical reaction ..... 9.17.4
  - Definition ..... 3.3.26, A.3.3.26
- Classification of liquids** ..... Chap. 4



- Class I liquids** ..... 6.4.1.2, 7.1, 16.5.1.4(1), A.1.2, A.6.4.1.2; *see also*  
  Class IA liquids; Class IB liquids; Class IC liquids
- Acceptable containers ..... 9.4.1, A.9.4.1
- Basement storage ..... 9.3.6
- Dispensing of ..... 9.18.2
- Hazardous materials storage lockers ..... 14.6.3
- Liquid processing facilities ..... 17.3.6, 17.6.6, 17.6.9, 17.11.1
- Loading facilities ..... 28.3.1.1, 28.4.1, 28.10.1, 28.11.1.3, 28.11.1.4,  
  28.11.1.6, 28.11.3, A.28.11.3
- Maximum allowable quantities, special occupancy  
  limits ..... 9.6.2.1, 9.6.2.2
- Mercantile occupancies ..... 10.8.1, 10.8.2, 10.8.4
- Operations ..... 18.4.1, 18.4.3, 18.4.4(3), 18.4.9, 18.5.2
- Risers, loading and unloading ..... A.27.10
- Storage cabinets ..... 9.5.1, 9.5.2
- Storage occupancies ..... 12.6.1.2, 12.8.4, A.12.8.4
- Storage rooms, electrical systems for ..... 9.12.2
- Storage tank buildings ..... 24.4.9, 24.5.3, 24.10.1, 24.14.3, 24.14.6,  
  24.14.8, A.24.14.6, A.24.14.8
- Storage tanks ..... 21.3.1, 21.4.1.2(3), 27.8.2.13
- Aboveground ..... 22.3, 22.4.1.1 to 22.4.1.3, 22.4.1.6 Ex.,  
  22.4.2.1 to 22.4.2.5, 22.5.2.3, 22.5.2.4, 22.7.1.1.3, 22.8.1,  
  22.11.2.5(1), 22.11.2.6.3.5, 22.13.3, 22.13.4, A.22.4.2.1,  
  A.22.5.2.4, A.22.8.1
- Underground ..... 23.4.2, 23.13.5, 23.13.6
- Vaults ..... 25.10.1
- Wharves ..... 29.3.12
- Class IA liquids** ..... 4.3.1, 9.3.2, 9.4.3.2, D.3
- Explosion control ..... 9.16.1, A.9.16.1
- Inside liquid storage areas ..... 16.1.2, A.16.1.2
- Maximum allowable quantities ..... 9.6.1
- Mercantile occupancies ..... 10.3.1
- Operations ..... 18.5.4, A.18.5.4.1(1)
- Storage occupancies ..... 12.8.2
- Storage tank buildings ..... 24.5.4, A.24.5.4
- Storage tanks, venting of ..... 21.4.3.8
- Class IB liquids** ..... 4.3.1, 9.4.3.1, 9.4.3.2, D.4
- Incidental operations ..... 18.5.4, A.18.5.4.1(1)
- Maximum allowable quantities ..... 9.6.1
- Mercantile occupancies ..... 10.7.1, 10.7.2
- Storage occupancies ..... 12.8.1, 12.8.2, A.12.8.1
- Storage tanks, venting of ..... 21.4.3.9, 21.4.3.11, A.21.4.3.11
- Class IC liquids** ..... 4.3.1, 9.4.3.1, 9.6.1
- Incidental operations ..... 18.5.4, A.18.5.4.1(1)
- Mercantile occupancies ..... 10.7.1, 10.7.2
- Spill control, containment, and drainage ..... 9.13.5
- Storage occupancies ..... 12.8.1, 12.8.2, A.12.8.1
- Storage tanks, venting of ..... 21.4.3.9, 21.4.3.11, A.21.4.3.11
- Class II liquids** ..... 4.3.2, 6.4.1.2, 6.4.1 Ex. 2, 7.1, 9.3.12,  
  A.1.2, A.6.4.1.2
- Acceptable containers ..... 9.4.1, A.9.4.1
- Basement storage ..... 9.3.7
- Dispensing of ..... 9.18.2
- Hazardous materials storage lockers ..... 14.6.3
- Inside liquid storage areas ..... 16.5.1.4(1)
- Liquid processing facilities ..... 17.3.6, 17.6.6, 17.11.1
- Loading facilities ..... 28.3.1.1, 28.3.1.3.2 Ex., 28.4.1, 28.10.1,  
  28.11.1.3, 28.11.1.6, 28.11.3, A.28.11.3
- Maximum allowable quantities ..... 9.6.1, 9.6.2.1, 9.6.2.2
- Mercantile occupancies ..... 10.7.1, 10.7.2, 10.8.1, 10.8.2, 10.8.4
- Operations ..... 18.3, 18.4.1, 18.4.4(3), 18.4.9, 18.5.2, 18.5.4,  
  A.18.5.4.1(1)
- Risers, loading and unloading ..... A.27.10
- Spill control, containment, and drainage ..... 9.13.5
- Storage cabinets ..... 9.5.1, 9.5.2
- Storage occupancies ..... 12.6.1.2, 12.8.1, 12.8.2, 12.8.4, A.12.8.1,  
  A.12.8.4
- Storage rooms, electrical systems for ..... 9.12.2
- Storage tank buildings ..... 24.4.9, 24.10.1, 24.14.3, 24.14.6,  
  24.14.8, A.24.14.6, A.24.14.8
- Storage tanks ..... 21.3.1, 21.4.1.2(3), 27.8.2.6, 27.8.2.13
- Aboveground ..... 22.3, 22.4.1.1 to 22.4.1.3, 22.4.1.6 Ex.,  
  22.4.2.1 to 22.4.2.5, 22.5.2.3, 22.5.2.4, 22.7.1.1.3, 22.8.2,  
  22.13.4, A.22.4.2.1, A.22.5.2.4
- Underground ..... 23.4.3, 23.13.6
- Wharves ..... 29.3.12
- Class III liquids** ..... 4.3.2, 6.4.1 Ex. 2, 6.4.1.2, 7.1, 9.3.12, 9.18.2,  
  A.1.2, A.6.4.1.2; *see also* Class IIIA liquids; Class IIIB  
  liquids
- Liquid processing facilities ..... 17.3.6, 17.11.1
- Loading facilities ..... 28.3.1.1, 28.3.1.3.2 Ex., 28.4.1, 28.10.1,  
  28.11.1.3, 28.11.3, A.28.11.3
- Operations ..... 18.3, 18.4.1, 18.4.4(3), 18.5.2, 18.5.4.1,  
  A.18.5.4.1(1)
- Storage rooms, electrical systems for ..... 9.12.2
- Storage tank buildings ..... 24.10.1
- Storage tanks ..... 21.3.1, 27.8.2.13
- Aboveground ..... 22.3, 22.4.2.2, 22.8.2
- Underground ..... 23.4.3
- Wharves ..... 29.3.12
- Class IIIA liquids** ..... 4.3.2, 10.7.2, 16.5.1.4(1)
- Acceptable containers ..... 9.4.1, A.9.4.1
- Basement storage ..... 9.3.7
- Liquid processing facilities ..... 17.6.6
- Maximum allowable quantities ..... 9.6.1, 9.6.2.1, 9.6.2.2
- Mercantile occupancies ..... 10.7.1
- Operations ..... 18.4.9, 18.5.4, A.18.5.4.1(1)
- Risers, loading and unloading ..... A.27.10
- Spill control, containment, and drainage ..... 9.13.5
- Storage cabinets ..... 9.5.1, 9.5.2
- Storage occupancies ..... 12.8.1, 12.8.2, A.12.8.1
- Storage tank buildings ..... 24.4.9, 24.14.8, A.24.14.8
- Storage tanks ..... 27.8.2.6
- Aboveground ..... 22.4.1.1 to 22.4.1.3, 22.4.2.1, 22.4.2.4,  
  22.4.2.5, 22.5.2.3, 22.5.2.4, 22.13.4, A.22.4.2.1, A.22.5.2.4
- Underground tanks ..... 23.13.6
- Class IIIB liquids** ..... 4.3.2, 16.5.1.4(2)
- Acceptable containers ..... A.9.4.1
- Automatic fire protection for ..... 16.3.4
- Basement storage ..... 9.3.8
- Detached buildings, storage in ..... 13.3.5 Ex.
- Fire protection system design criteria ..... 16.5.2.5
- Liquid processing facilities ..... 17.6.5
- Maximum allowable quantities ..... 9.6.1, 9.6.2.1, 9.6.2.4
- Spill control, containment, and drainage ..... 9.13.4
- Storage occupancies ..... 12.8.1, 12.8.2, A.12.8.1
- Storage tanks ..... 21.4.1.2, 22.4.1.6, 22.4.2.1.2, 22.7.1.1.3
- Closed containers** ..... 18.4.1
- Definition ..... 3.3.12.1
- Closed-top diking** ..... 22.11.3, A.22.11.3.1
- Definition ..... 3.3.11
- Code**
- Adoption and enforcement ..... Annex H
- Definition ..... 3.2.3, A.3.2.3
- Collision protection, tanks** ..... 22.11.3.9, 22.11.4.7, 22.15
- Combustible liquids**
- Classification ..... 4.3.2
- Definition ..... 3.3.33.1, 4.2.2
- Commercial kitchens, cooking oil storage tanks in** ..... 19.7,  
  A.19.7.1.3 to A.19.7.5.2
- Compartmented tank** ..... 21.4.3.2, 22.7.1.1.1, A.21.4.3.2
- Definition ..... 21.2.1
- Composite intermediate bulk containers** ..... *see* Intermediate bulk  
  containers, nonmetallic
- Concrete tanks** ..... 21.4.1.3
- Connectors, flexible** ..... *see* Flexible connectors
- Construction** ..... 9.9; *see also* Damage-limiting construction
- Detached, unprotected buildings ..... 13.9
- Hazardous materials storage lockers ..... 14.4
- Inside liquid storage areas ..... 9.9
- Liquid processing facilities ..... 17.6, A.17.6.8 to A.17.6.11
- Mercantile occupancies ..... 10.9

Process facilities ..... <i>see</i> Process facilities, design and construction of	Storage tank buildings ..... 24.5, A.24.5.2 to A.24.5.6	Storage tank buildings ..... 24.9.6, A.24.9.6
Storage occupancies ..... 12.9	Storage tanks ..... 21.3.2, 21.3.5, 21.4, 23.14, A.21.4.2.1.1, A.21.4.2.3.2, A.23.14.1	Vaults ..... 25.3.1.2, 25.5, A.25.5
<b>Containers</b> ..... <i>see also</i> Tanks	Acceptable ..... 9.4, A.9.4.1	Automatic fire protection for ..... <i>see</i> Inside storage, automatic fire protection systems for
Closed ..... 18.4.1	Definition ..... 3.3.12.1	Definition ..... 3.3.12, A.3.3.12
Fiberboard and fiber drums ... 9.4.1(5), 9.4.3; <i>see also</i> Nonmetallic containers	Fire protection ..... Annex D	Glass ..... 9.4.1(7), 9.4.3, 9.4.3.2, 16.5.2.7, 16.5.2.12; <i>see also</i> Nonmetallic containers
Intermediate bulk ..... <i>see</i> Intermediate bulk containers (IBCs)	Leaking or damaged container, storage of ..... 9.4.3.3	LP-Gas ..... 22.4.2.4 to 22.4.2.6
Mercantile occupancies ..... 10.1.3, 10.3.3	Metal ..... 9.4.1, 9.4.3, 12.6.2.2, 16.2.3, 16.3.6, 16.4.1.1, 16.4.1, 16.5.2.1 to 16.5.2.4, 16.5.2.6, 16.5.2.8, 16.5.2.11, A.9.4.1, A.16.2.3, D.3; <i>see also</i> subentry: Relieving-style	Nonmetallic ..... <i>see</i> Nonmetallic containers
119 gal (450 L) or less capacity	Detached unprotected buildings ..... Chap. 13	Industrial occupancies ..... Chap. 11
Mercantile occupancies ..... Chap. 10	Storage occupancies ..... Chap. 12	Plastic ..... 9.4.1, 9.4.3.1, 9.4.3, A.9.4.1, D.4; <i>see also</i> Nonmetallic containers
Fire protection systems ..... 16.5.2.7, 16.5.2.12	Mercantile occupancies ..... 10.8.4	Storage occupancies ..... 12.8.4, A.12.8.4
Relieving-style ..... 16.3.6, 16.5.1.7, 16.5.2.1 to 16.5.2.4, 16.5.2.8	Definition ..... 16.2.3, A.16.2.3	Safety cans ..... <i>see</i> Safety cans
Size, maximum ..... 9.4.3, 9.4.3	Stacking ..... 9.3.9, 12.6.1.2, 14.6.3, A.9.3.9.3	Storage of ..... <i>see also</i> Hazardous materials storage lockers; Inside liquid storage areas; Outdoor storage
Detached, unprotected buildings, storage in ..... Chap. 13	Electrical area classification ..... 7.3.3	Industrial occupancies ..... Chap. 11
Mercantile occupancies ..... Chap. 10	Protected ..... Annex D, Annex E; <i>see also</i> Inside storage, automatic fire protection systems for	Storage occupancies ..... Chap. 12
Transfer of liquids from/to ..... 18.4.4, 18.5.2, 18.5.6, A.18.4.8, A.18.5.6(3)	Valves ..... 27.4.3.1	Venting ..... 9.4.2, 21.4.3, 27.8, A.21.4.3.2, A.21.4.3.11, A.27.8.1.6, A.27.8.2.1
Aboveground tanks ..... <i>see</i> Aboveground storage tanks	Capacity ..... 23.6.1, 23.6.3, A.23.6.1	Cooking oil storage ..... 19.7.2.3, 19.7.2.4, A.19.7.2.3.4, A.19.7.2.4.2
Underground tanks ..... <i>see</i> Underground tanks	<b>Containment</b> ..... <i>see also</i> Impounding	Detached, unprotected buildings ..... 13.13
Emergency planning ..... 6.8.1(4)	Hazardous materials storage lockers ..... 14.4.8, A.14.1	Inside liquid storage areas ..... 16.8, A.16.8.2
Liquid processing facilities ..... 17.15.4(4)	Liquid storage areas ..... 9.13, A.9.13	Loading and unloading facilities ..... 28.9, A.28.9
Mercantile occupancies ..... 10.13	Secondary (definition) ..... 27.2.5	Storage tank buildings ..... 24.9.6, A.24.9.6
Vaults ..... 25.3.1.2, 25.5, A.25.5	<b>Control areas</b> ..... 9.7	Below grade ..... 9.7.2, 9.7.3
Definition ..... 3.3.2.1	Maximum allowable quantities per ..... 9.6	Classification of occupancies exceeding ..... 9.8, A.9.8.1, A.9.8.2
Mercantile occupancies ..... 10.7, 10.9.1	Storage occupancies ..... 12.3.1, 12.7	Water-reactive materials, separation of liquids from ..... 9.17.4
<b>Cooking oil</b>	Definition ..... 19.2.1, A.19.2.1	<b>Cooking oil storage tanks</b> ..... 19.7, A.19.7.1.3 to A.19.7.5.2
<b>Corrosion and corrosion protection</b>	Definition ..... 27.2.1	Piping systems ..... 27.6.4, A.27.6.4
Tanks ..... 21.4.5, A.21.4.5	External ..... 23.3.5, A.23.3.5	Internal ..... 21.4.5, A.21.4.5
Roof tank pontoons ..... 22.17.4, A.22.17.4	<b>Crude petroleum</b> ..... 6.4.1 Ex. 3, 17.15.2 Ex. 3, 21.4.3.10, 22.4.2.1.1, 22.11.2.6.3.2	Definition ..... 3.3.13
<b>Cryogenic fluids</b> ..... 1.1.2(3)	Definition ..... 3.3.14	<b>-D-</b>
<b>Damage-limiting construction</b> ..... 9.16.1, 17.6.13, 24.5.4, 24.5.5, A.9.16.1, A.24.5.4; <i>see also</i> Deflagration venting	Definition ..... 3.3.15	<b>Day-care occupancies</b>
Definition ..... 3.3.39.4	Maximum allowable quantities per control area ..... 9.6.2.1, 9.6.2.2, 9.6.2.4	<b>Definitions</b> ..... Chap.3, 4.2, A.4.2.1 to A.4.2.6
Aboveground tanks ..... 22.2	Automatic fire protection systems for fire protection ..... 16.2, A.16.2.3, A.16.2.4	Piping systems ..... 27.2
Specific operations ..... 19.2, A.19.2.1	Storage tanks ..... 21.2	<b>Deflagration venting</b> ..... 17.6.13, 24.5.4, A.14.1, A.17.14, A.24.5.4
<b>Deluge systems</b> ..... 6.9.1, 24.6.2.3, A.24.6.2.3, E.2.2.1, E.2.2.4, E.2.3.3, E.2.4.10, E.2.6.2	<b>Design</b>	Hazardous materials storage lockers ..... 14.4
Inside storage, automatic fire protection systems for ..... 16.5, 16.6, A.16.5.1.6.2, A.16.6.1.5	Pressure vessels ..... 21.4.2.3, A.21.4.2.3.2	Process facilities ..... <i>see</i> Process facilities, design and construction of
Recirculating heat transfer system ..... 19.4.3, A.19.4.3	Storage tanks ..... 19.7.2, 19.7.5.1, 19.7.5.2, 21.3.3 to 21.3.5, 21.4, A.19.7.2.1.2 to A.19.7.2.6.2, A.19.7.5.1, A.19.7.5.2, A.21.4.2.1.1 to A.21.4.5	Vaults ..... 25.5, A.25.5
<b>Detached, unprotected buildings, storage in</b> ..... Chap. 13	<b>Detection systems</b>	Leaks ..... <i>see</i> Leakage detection and control
Liquid processing operations ..... 6.6, A.6.6.2	Storage tank buildings ..... 24.15	Vaults ..... 25.15
<b>Detention and correctional occupancies</b>	Definition ..... 3.3.39.5	Maximum allowable quantities per control area ..... 9.6.2.1, 9.6.2.2
<b>Detonation arresters</b> ..... A.19.5.7.6	<b>Dikes around tanks</b> ..... 22.4.1.6 Ex., 22.4.2.1.2, 22.4.2.3, 22.4.2.4.1, 22.4.2.4.2, 22.12, A.22.12.1, A.22.12.3	Closed-top diking ..... 22.11.3, A.22.11.3.1
Definition ..... 3.3.11	Open diking ..... 22.11.2, A.22.11.2.2 to A.22.11.2.6.3.4	Pipe penetrations ..... 27.6.3
<b>Dispensing of liquids</b>	Detached, unprotected buildings ..... 13.18	

- Hazardous materials storage lockers ..... 14.4.6, A.14.1  
 Liquid storage areas ..... 9.14, 9.18  
 Mercantile occupancies ..... 10.1.2, 10.8.2, 10.18  
 Storage occupancies ..... 12.14, 12.18  
 Ventilation, dispensing areas ..... 18.4, 25.10.3, A.18.4.8
- Displays, mercantile occupancies** ..... 10.7.1, 10.8, 10.10.2
- Distillery (definition)** ..... 3.3.16; *see also* Solvent distillation units
- Doors, fire** ..... 9.9.2
- Drainage**
- Aboveground storage tanks ..... 22.7.3.5 to 22.7.3.7, 22.11.1, 22.11.3.5, A.22.7.3.6, A.22.7.3.7
  - Detached, unprotected buildings ..... 13.13
  - Electrical area classification ..... 7.3.3
  - Emergency planning ..... 6.8.1(4)
  - Fire protection systems ..... 16.8, A.16.8.2
  - Impoundment or diked areas ..... 22.4.2.3, 22.11.1, 22.12.2
  - Liquid processing facilities ..... 17.6.8(1), 17.10, 17.15.4(4), A.17.10.1
  - Liquid processing operations ..... 18.5.6(2)
  - Liquid storage areas ..... 9.13, A.9.13
  - Loading and unloading facilities ..... 28.9, A.28.9
  - Mercantile occupancies ..... 10.13.1
  - Outdoor storage ..... 15.3.5.1
  - Recirculating heat transfer systems ..... 19.4.3.1, 19.4.3.2, A.19.4.3.1, A.19.4.3.2
  - Storage tank buildings ..... 24.9, A.24.9.6
  - Vaults ..... 25.9
- Drums** ..... *see also* Portable tanks (660 gal [2500 L] or less capacity)
- Fiber ..... 9.4.1(5), 9.4.3
  - Metal ..... 9.4.3
  - Overpack ..... 9.1.3, 9.4.3.3
  - Storage in ..... Chap. 9
    - Detached unprotected buildings ..... Chap. 13
    - Electrical area classification ..... Table 7.3.3
    - Outdoor storage ..... *see* Outdoor storage
    - Storage occupancies ..... Chap. 12
- Dry chemical extinguishers** ..... 29.3.28.4, A.29.3.28
- Dry chemical extinguishing systems** ..... 6.7.6, 16.9, 24.6.2.4, A.14.1
- Dwellings**
- Multifamily (definition) ..... 3.3.17.1
  - One-family (definition) ..... 3.3.17.2
  - Two-family (definition) ..... 3.3.17.3
- Dwelling units (definition)** ..... 3.3.18
- E-**
- Educational occupancies**
- Definition ..... 3.3.39.6
  - Maximum allowable quantities per control area ..... 9.6.2.1, 9.6.2.2, 9.6.2.4
- Electrical area classifications** ... 7.3.3 to 7.3.7, 9.12.1, 9.12.2, 10.12.2, 10.12.3, 19.5.7.2, 29.3.22, A.7.3.3, A.7.3.7, A.19.5.7.2, A.27.8.2.1
- Electrical systems** ..... Chap. 7
- Detached, unprotected buildings ..... 13.12
  - Hazardous materials storage lockers ..... 14.4.5, A.14.1
  - Liquid processing facilities ..... 17.9
  - Liquid processing operations ..... 6.5.5
  - Liquid storage areas ..... 9.12
  - Mercantile occupancies ..... 10.12
  - Remote impoundment or diked areas ..... 22.12.3, A.22.12.3
  - Storage occupancies ..... 12.12
  - Storage tank buildings ..... 24.8
  - Storage tank heating ..... 19.7.2.6, A.19.7.2.6.1, A.19.7.2.6.2
  - Tank vehicle and tank car loading/unloading facilities ..... 28.8
  - Vapor recovery and processing systems ..... 19.5.7.2, A.19.5.7.2
  - Vaults ..... 25.8
  - Wharves ..... 29.3.22
- Emergency planning and training**
- Liquid processing facilities and operations ... 6.8, 17.15.2, 17.15.4
  - Recirculating heat transfer systems ..... 19.4.7.1, A.19.4.7.1
  - Storage tanks ..... 21.6.4, 21.6.5, A.21.6.5.1
    - In flood areas ..... 21.7.3.3
- Emergency relief vents** ..... 17.15.3
- Aboveground tanks ..... 22.7, 22.9.2, 22.10.2, 22.11.3.12, A.22.7.3.1 to A.22.7.4, Annex B
    - Pressure-relieving devices ..... 22.7.3, A.22.7.3.1 to A.22.7.3.10.4
    - Weak roof-to-shell seam construction ..... 22.7.2
  - Containers and portable tanks ..... 9.4.2
  - Cooking oil storage tanks ..... 19.7.2.4, A.19.7.2.4.2
  - Definition ..... 3.3.60.1
  - Extension of piping for ..... 27.8.1.6, A.27.8.1.6
  - Maintenance ..... 21.8.6, A.21.8.6
  - Storage tank buildings ..... 24.13.3, 24.13.6
- Emergency responders**
- Access for ..... A.25.3.1
  - Information for ..... 19.7.4.1, 21.6.5.6, 21.7.2.1
- Emergency shutdown**
- Tank storage facilities ..... 21.6.5.1, 21.6.5.4, A.21.6.5.1
  - Vapor processing systems ..... 19.5.8
- Emissions, fugitive** ..... *see* Fugitive emissions
- Enforcement of code** ..... Annex H
- Equivalency to code** ..... 1.5
- Evacuation** ..... 6.9.5
- Exhaust systems** ..... *see* Ventilation
- Explosion hazards**
- Analysis of ..... 6.4, A.6.4.1.1, A.6.4.1.2
  - Management of ..... 6.3, 17.15.3, 21.6, A.6.3, A.21.6.5.1, A.21.6.6.1
- Explosion protection and control** ..... 9.16, A.9.16.1, A.9.16.2; *see also* Damage-limiting construction; Deflagration venting
- Detached, unprotected buildings ..... 13.16
  - Processing facilities ..... A.17.14
  - Roof tanks ..... 22.17.4, A.22.17.4
  - Storage occupancies ..... 12.16
  - Vapor processing systems ..... 19.5.7.7, A.19.5.7.6
- Explosion risk control** ..... Chap. 6
- Exposures, protection for (definition)** ..... 3.3.46; *see also* Separation
- Extinguishers, portable fire** ..... 6.7.8, 9.10.2, 10.10.3, 24.6.1.1, 29.3.28.4, A.6.7.8, A.24.6.1.1
- Extinguishing systems** ..... *see* Fire protection
- F-**
- Fiberboard and fiber drums** ..... 9.4.1(5), 9.4.3; *see also* Nonmetallic containers
- Fill pipes**
- Loading and unloading facilities ..... 28.3.1.2.1, 28.3.1.2.3, 28.3.1.3, A.28.3.1.2
  - Storage tank buildings ..... 24.14.7
  - Storage tanks ..... 21.4.4, A.21.4.4
  - Testing ..... 21.5.1.2
  - Underground tanks ..... 23.13.3 to 23.13.6
- Fire apparatus and equipment** ..... *see also* Fire protection
- Inspection and maintenance ..... 6.9.1, 17.15.4(4)
  - Liquid processing operations ..... 6.7.9, 17.15.4(4)
  - Wharves ..... 29.3.28, A.29.3.28
- Fire area (definition)** ..... 3.3.2.2
- Fire code (definition)** ..... 3.3.19
- Fire doors** ..... 9.9.2
- Fire hazards**
- Analysis of ..... 6.4, A.6.4.1.1, A.6.4.1.2
  - Management of ..... 6.3, 17.15, 21.6, A.6.3, A.21.6.5.1, A.21.6.6.1
- Fire point** ..... 9.1.4, 10.1.3(5)
- Definition ..... 3.3.20
- Fire prevention** ..... Chap. 6
- Management of operation hazards ..... 17.15
  - Storage tanks ..... 21.6, A.21.6.5.1, A.21.6.6.1
- Fire protection** ..... *see also* specific systems, e.g., Sprinkler systems
- Alternate systems ... 10.10.2, 12.3.4, 16.9, 17.6.8, 19.4.6.2, A.17.6.8
  - Container and portable tank storage ..... 9.10, Annex D, Annex E; *see also* Inside storage, automatic fire protection systems for
  - Decision trees ..... 16.4.1
  - Detached, unprotected buildings ..... 13.10
  - Hazardous materials storage lockers ..... A.14.1

Inside storage, automatic protection for ..... *see* Inside storage, automatic fire protection systems for

Manual systems ..... 9.10.2, 13.10.2, 24.6.1, A.6.6.1; *see also* Extinguishers, portable fire

Mercantile occupancies ..... 10.7.1, 10.8.1, 10.10

Operations ..... 6.7, 17.15.3, 17.15.4, 19.4.6, A.6.7.1 to A.6.7.8, A.19.4.6.1

Storage occupancies ..... 12.3.4 to 12.3.6, 12.6.1, 12.10

Storage tank buildings ..... 24.6, 24.15, A.24.6.1.1 to A.24.6.2.3

Storage tanks ..... 21.4.1.2(4), 21.6, A.21.6.5.1, A.21.6.6.1

  Aboveground ..... 22.8, 22.10, A.22.8.1

  Cooking oil ..... 19.7.4, A.19.7.4.2

  Remote impoundment or diked areas ..... 22.12.4

  Roof tanks ..... 22.8, A.22.8.1

Vaults ..... 25.6

Wharves ..... 29.3.28, A.29.3.28

**Fire pumps** ..... 29.3.28.3

**Fire-resistance of storage tank buildings** ..... 24.4.2, 24.5.2, A.24.5.2

**Fire-resistant tanks** ..... 22.9

  Definition ..... 22.2.1

**Fire tests for storage protection** ..... Annex D, Annex E

**Fittings**

  Liquid processing operations ..... 18.4.6

  Materials for ..... 27.4.1

  Wharves ..... 29.3.11

**Flame arresters** ..... 21.4.3.9, 21.4.3.11, A.19.5.7.6, A.21.4.3.11

**Flame propagation** ..... 19.5.7.6, A.19.5.7.6

**Flammable liquids**

  Classification ..... 4.3.1

  Definition ..... 3.3.33.2, 4.2.3, A.3.3.33.2

**Flash point** ..... 1.1.2, 4.3.1, 4.3.2, 9.1.4, 10.1.3(6), A.1.1.2(4), A.1.2

  Basement, liquids stored in ..... 24.4.9

  Changes in, hazards due to ..... 28.11.3, A.28.11.3

  Class IIIB liquid operations at temperatures below ..... 17.6.5

  Definition ..... 3.3.21, 4.2.4, A.4.2.4

  Determination of ..... 4.4

  Electrical classification for liquids stored above ..... 9.12.2 Ex.

  Heat transfer fluid heated up to or above ..... 19.4.1.1

  Storage, processing, handling, and use at temperatures

    below ..... 6.4.1 Ex. 2, 12.3.7 Ex., 13.3.5, 17.5.2 Ex. 2, 17.6.5, 22.8.2, 28.3.1.1(2), 28.4.1, 29.3.8

  Storage, processing, handling, and use of liquids at temperatures

    at or above ..... 6.4.1.2, 7.1, 9.3.12, 17.3.6, 17.3.7, 17.11.1, 18.4.1, 21.3.1, 21.4.2.1.6, 22.3, 23.3.1, 24.1.2, 24.4.9, 24.10.1, 28.4.1, 29.3.12, 29.3.22, A.6.4.1.2

  Transfer of liquids at temperature at or above ..... 9.18.2, 18.3, 18.5.2, 28.11.1.3

  Transfer of liquids at temperatures below ..... 17.15.2 Ex. 2, 28.3.1.3.2 Ex.

**Flexible connectors** ..... 18.4.7, 27.5.2

  Definition ..... 27.2.2

**Floating roof tanks**

  Definition ..... 22.2.2

  Electrical area classification ..... 7.3.3

  Extinguishing system ..... 22.8.2

  Pontoons, inspection of ..... 22.17.4, A.22.17.4

**Flooding, tanks in areas subject to** ..... 19.7.3.2.3, 21.7.3, 21.8.5, 22.5.2.5, 22.14, 23.14, A.23.14.1

**Foam apparatus, mobile** ..... 6.7.9, 24.6.1.3

**Foam extinguishing systems** ..... 6.7.6, 6.9.1, 16.5.1.2, 16.9, 22.12.4, 24.6.2.3, 29.3.28.3, A.24.6.2.3, A.29.3.28, D.5, E.2.2.1, E.2.2.5, E.2.3.3, E.2.6.2, E.2.6.3

**Foams (liquids as)** ..... 1.1.2(6)

**Foam-water sprinkler systems** ..... 6.7.6, 6.9.1, 16.4, 16.5.1.2, 16.5.1.6, 24.6.2.3, 24.6.2.4, A.16.5.1.6.2, A.24.6.2.3, D.3, E.2.4.10

**Formulas** ..... 1.6

**Frictional heat or sparks** ..... 6.5.1(8), A.6.5.1(8)

**Fuel burner controls and interlocks** ..... 19.4.4, A.19.4.4

**Fuel oil** ..... *see* Oil

**Fugitive emissions** ..... 24.10.2, A.24.10.2

  Calculations ..... Annex F

  Definition ..... 3.3.22, A.3.3.22

## -G-

**Gases** ..... *see* Inert gas pressure; Liquefied gases

**Gas-fired heaters** ..... 19.4.4, A.19.4.4

**Glass containers** ..... *see* Containers

**Grounding** ..... 6.5.4.2, 6.5.4.3

  Definition ..... 3.3.23

  Loading and unloading facilities ..... 28.3.1, A.28.3.1.2

  Piping systems ..... 27.9

  Wharves ..... 29.3.12

## -H-

**Handling, dispensing, transfer, and use of liquids** ..... Chap. 18

**Hazardous materials or chemicals (definition)** ..... 3.3.24, A.3.3.24

**Hazardous materials storage lockers** ..... 12.6.1.2 Ex., Chap. 14

  Definition ..... 3.3.25

  Designated sites ..... 14.5

  Electrical area classification ..... 7.3.3

  Mercantile occupancies ..... 10.3.6, 10.9.2, 10.13.2, A.10.3.6

  Separation ..... 14.5.2

    From combustible materials ..... 14.6.5

    Between individual lockers ..... 14.5.2, 14.5.4

  Spill or leakage control ..... 14.4.8

  Storage practices ..... 14.6

**Hazardous reaction or hazardous chemical reaction** ..... 9.17.4

  Definition ..... 3.3.26, A.3.3.26

**Health care occupancies** ..... 3.3.39.7

  Definition ..... 3.3.39.7

  Maximum allowable quantities per control area ..... 9.6.2.1, 9.6.2.2, 9.6.2.4

**Heat transfer fluid (HTF)** ..... 19.4, A.19.4.2 to A.19.4.7.1

  Definition ..... 3.3.27

**Heat transfer systems, recirculating** ..... 19.4, A.19.4.2 to A.19.4.7.1

**High hazard level 2 contents** ..... 9.8.1.1

  Definition ..... 3.3.28

**High hazard level 3 contents** ..... 9.8.1.2

  Definition ..... 3.3.29

**Hose**

  Cargo ..... 29.3.9

  Transfer ..... 18.4.7, 18.5.2.1, 28.11.1.3, 28.11.1.11, 28.11.2.5

**Hose lines** ..... 9.10.2.3 to 9.10.2.6, 10.10.4, 16.6.1.10, 16.6.2.9, 16.6.3.8, 16.7, 22.12.4, 24.5.7, 24.6.1.2, 29.3.28.3, A.24.6.1.2, A.29.3.28; *see also* Standpipe and hose systems

**Hotels (definition)** ..... 3.3.30

**Hot work** ..... 6.5.3, A.6.5.3

**Hydrants** ..... 6.7.4, 16.7, 24.6.2.2, 29.3.28.2, A.24.6.2.2, A.29.3.28

## -I-

**Identification**

  Piping systems ..... 27.10, A.27.10

  Storage cabinets ..... 9.5.5, A.9.5.5

  Storage tanks ..... 19.7.4.1, 21.7.2, A.21.7.2.2

**Ignition sources, control of**

  Liquid processing operations ..... 6.5, 18.4.3, A.6.5.1(8) to A.6.5.4, A.17.14

  Loading facilities ..... A.28.11.3

  Solvent distillation units ..... 19.6.4.3

  Storage tanks ..... 21.6.2, 22.13.4, 22.17.4, A.22.17.4

  Vapor processing systems ..... 19.5.7, A.19.5.7.2 to A.19.5.7.6

  Wharves ..... 29.3.19

**Important buildings** ..... 22.4.1

  Definition ..... 3.3.8.1, A.3.3.8.1

**Impounding**

  By diking ..... *see* Dikes around tanks

  Remote ..... 22.11.1, 22.12, A.22.12.1, A.22.12.3

**Incidental liquid use or storage** ..... 18.5, A.18.5.1 to A.18.5.6(3)

  Definition ..... 3.3.31



- Incompatible materials**  
 Separation from ..... 9.17, 10.17, 12.17, 13.17, A.14.1  
 Spontaneous ignition of ..... A.19.5.7.4  
 Tank construction materials, compatibility of ..... 21.4.1.1, 21.4.1.4
- Industrial occupancies** ..... Chap. 11  
 Definition ..... 3.3.39.8  
 Detached buildings, separation of ..... 13.3.1, 13.3.2, A.13.3.1, A.13.3.2
- Industrial trucks** ..... 9.3.9.3, A.9.3.9.3
- Inert gas pressure**  
 Liquid transfer using ..... 18.4.4  
 Tightness testing ..... 21.5.2, A.21.5.2
- Inerting system** ..... 22.4.1.4, A.17.14, C.4.9.2
- In-rack sprinklers** ..... 16.5.1.3, 16.6.1.1 to 16.6.1.7, 16.6.2.1 to 16.6.2.5, 16.6.3.1 to 16.6.3.6, 16.6.4, A.16.6.1.5, D.3
- Inside liquid storage areas** ..... *see also* Detached, unprotected buildings, storage in  
 Accessibility ..... 9.9.3  
 Construction features ..... 9.9  
 Definition ..... 3.3.2.3  
 Electrical systems ..... 7.3.3, 9.12  
 Explosion control ..... 9.16, A.9.16.1, A.9.16.2  
 Fire protection ..... 9.10, 12.3.9, Annex D, Annex E; *see also* Inside storage, automatic fire protection systems for  
 Fire resistance ratings ..... 9.9.1  
 General requirements ..... 9.3, A.9.3.9.3  
 Mercantile occupancies ..... 10.3.6, 10.12.2, 10.13.2, A.10.3.6  
 Operations ..... 9.13.1, 9.18.1  
 Spill control, drainage, and containment ..... 9.13, A.9.13  
 Storage occupancies ..... 12.3.9, 12.3.10, 12.3.12, 12.14  
 Storage tanks constructed of combustible materials in ..... 21.4.1.2(4)  
 Ventilation ..... 9.14, 18.6, A.18.6.3  
 Detached buildings ..... 13.14  
 Mercantile occupancies ..... 10.14  
 Storage occupancies ..... 12.14
- Inside storage, automatic fire protection systems for** ..... Chap. 16  
 Alternate systems ..... 16.9  
 Containment and drainage ..... 16.8, A.16.8.2  
 Definitions ..... 16.2, A.16.2.3, A.16.2.4  
 Design criteria ..... 16.5, A.16.5.1.6.2  
 Design schemes ..... 16.6, A.16.6.1.5  
 General requirements ..... 16.3  
 Sprinkler and foam-water systems ..... 16.4  
 Water supply ..... 16.7
- Inspection and maintenance**  
 Cargo hose ..... 29.3.10  
 Fire protection systems ..... 16.4.3  
 Liquid processing operations ..... 6.9  
 Piping systems ..... 27.7.3  
 Storage tank buildings ..... 24.16  
 Storage tanks ..... 21.6.6, 21.8, A.21.6.6.1, A.21.8.1 to A.21.8.8  
 Aboveground ..... 22.17, A.22.17.4  
 Underground tanks ..... 23.17  
 Vapor recovery and vapor recovery systems ..... A.19.5.7.2  
 Vaults ..... 25.16, A.25.3.1  
 Wharves ..... 29.3.10
- Intermediate bulk containers (IBCs)** ..... Chap. 9, E.1, E.2.3.3, E.2.6.3; *see also* Inside liquid storage areas; Portable tanks (660 gal [2500 L] or less capacity)  
 Acceptable ..... 9.4, A.9.4.1  
 Definition ..... 3.3.12.2, 16.2.1  
 Detached unprotected buildings ..... Chap. 13  
 Emergency venting ..... 9.4.2  
 Hazardous materials storage lockers ..... *see* Hazardous materials storage lockers  
 Incidental operations, liquids for ..... 18.5.4, A.18.5.4.1(1)  
 Industrial occupancies ..... Chap. 11  
 Inside storage, fire protection for ..... *see* Inside storage, automatic fire protection systems for  
 Liquid handling, transfer, and use ..... 18.4.8, 18.4.9 Ex. 1, A.18.4.8
- Mercantile occupancies ..... 10.1.3(1), 10.12.2  
 Metal ..... 9.4.1, 9.4.3, 12.6.2.2, 15.3, 16.2.3, 16.4.1.1, 16.5.2.1 to 16.5.2.4, 18.5.4, A.9.4.1, A.16.2.3, A.18.5.4.1(1)  
 Nonmetallic ..... 9.4.1, 12.6.2.2, 15.3, 16.3.7, 16.4.1.2, 16.4.1.3, 16.5.1.8, 16.5.2.5, 16.5.2.9, 16.5.2.10, 18.5.4, A.9.4.1, A.18.5.4.1(1)  
 Definition ..... 3.3.12.4, A.3.3.12.4, A.9.4.1(6)  
 Outdoor storage ..... *see* Outdoor storage  
 Relieving-style ..... *see* Containers, Relieving-style  
 Size, maximum ..... 9.4.3  
 Stacking ..... 9.3.9, A.9.3.9.3  
 Storage occupancies ..... Chap. 12
- Isolation valves** ..... 27.6.7
- J-**
- Joints, pipe** ..... 27.5, A.27.5.1.2  
 Flexible connectors ..... 18.4.7, 27.5.2  
 Friction ..... 27.5.3, 29.3.11  
 Recirculating heat transfer systems ..... 19.4.5.2.2, 19.4.5.3.1  
 Tightness of ..... 27.5.1, A.27.5.1.2  
 Wharves ..... 29.3.11, 29.3.13
- L-**
- Labeled (definition)** ..... 3.2.4
- Leakage detection and control** ..... *see also* Spillage  
 Liquid processing operations ..... 6.6.2, 6.9.2, 17.10.1, 18.4.2, A.17.10.1  
 Piping systems ..... 19.4.5.3.1, 19.4.5.3.2, 27.3.2  
 Recirculating heat transfer systems ..... 19.4.5.3.1, 19.4.5.3.2, 19.4.7.2  
 Roof tank pontoons ..... 22.17.4, A.22.17.4  
 Storage of leaking or damaged containers ..... 9.4.3.3  
 Storage tanks ..... 21.4.1.2(3), 21.5.1.3, 21.8.4  
 Underground tanks ..... 21.7.5, 28.10.2, A.21.7.5  
 Vaults ..... 25.9, 25.10.2, 25.15
- Leak (definition)** ..... 27.2.3
- Lightning protection systems** ..... A.22.17.4
- Liquefied gases** ..... 1.1.2(3)  
 Definition ..... 3.3.32  
 LP-Gas ..... 22.4.2.4 to 22.4.2.6
- Liquid** ..... *see also* Classification of liquids; Combustible liquids; Flammable liquids; Stable liquids; Unstable liquids; Water-miscible liquids  
 Classification ..... *see* Classification of liquids  
 Definition ..... 3.3.33, 4.2.5  
 Flash point ..... *see* Flash point  
 Without flash points ..... 1.1.2(4)
- Liquid detection** ..... *see* Leakage detection and control
- Liquid level monitoring, vapor collection system** ..... 19.5.5, A.19.5.5.1
- Liquid processing operations** ..... *see* Process or processing
- Liquid storage areas** ..... *see* Inside liquid storage areas
- Liquid storage rooms** ..... 9.8.2, A.9.8.2  
 Accessibility ..... 9.9.3  
 Definition ..... 3.3.34  
 Electrical systems ..... 9.12.2  
 Explosion control ..... 9.16.1 Ex.  
 Fire resistance ratings ..... 9.9.1, 9.9.2  
 Hazardous materials storage lockers used as ..... 14.3.1  
 Mercantile occupancies ..... 10.3.6, 10.9.2, 10.13.2, A.10.3.6  
 Storage occupancies ..... 12.3.2, 12.6.1, 12.8.4, A.12.8.4
- Liquidtight** ..... 21.8.4, 22.2.2(3), 22.11.2.4, 22.11.3.4, 22.13.4.2, 22.14.3, 23.13.1, 23.13.2, 24.9.3, 24.9.4, 24.14.2, A.9.13, A.22.11.2.4.1, A.24.14.8, A.25.5  
 Closures, storage tank ..... 19.7.3.3.2, 22.13.2, 22.13.4.2, 23.13.6.1, A.19.7.3.3.2  
 Definition ..... 3.3.35  
 Intermediate bulk containers ..... A.9.4.1(6)  
 Piping ..... 27.3.2, 27.5.1.1, 27.5.3.1, 27.5.3.3(2), 28.10.2  
 Tightness testing ..... 21.5.2, A.21.5.2
- Liquid warehouses** ..... 9.8.2, A.9.8.2  
 Accessibility ..... 9.9.3



Definition .....	3.3.62.2
Fire resistance ratings .....	9.9.1, 9.9.2
Storage occupancies .....	12.3.2, 12.6.1.2 Ex., 12.6.2, 12.8.4, A.12.8.4
<b>Listed (definition)</b> .....	3.2.5, A.3.2.5
<b>Loading operations</b> .....	7.3.3, Chap. 28, 29.3.2, 29.3.27
<b>Lockers</b> .....	<i>see</i> Hazardous materials storage lockers
<b>Lower flammable limit (LFL)</b> .....	22.17.4, A.22.17.4
Definition .....	3.3.37
<b>Low melting point materials</b> .....	27.4.4
Definition .....	27.2.4
<b>Low-pressure tanks</b> .....	21.4.2.2
Definition .....	3.3.51.3
Use as atmospheric tanks .....	21.4.2.1.5
Venting .....	21.4.3.5, 21.4.3.7
<b>LP-Gas</b> .....	22.4.2.4 to 22.4.2.6

**-M-**

<b>Maintenance</b> .....	<i>see</i> Inspection and maintenance
<b>Manual fire protection activities</b> .....	6.9.5, 21.6.6.4, E.2.6.3
<b>Manual fire protection systems</b> ....	9.10.2, 13.10.2, 24.6.1, A.6.6.1; <i>see also</i> Extinguishers, portable fire
<b>Marine piping</b> .....	27.11
<b>Marking</b> .....	<i>see</i> Identification
<b>Maximum allowable quantities (MAQs)</b>	
Definition .....	3.3.38, A.3.3.38
Detached, unprotected buildings .....	13.6
For incidental operations .....	18.5.4, A.18.5.4.1(1)
Mercantile occupancies .....	10.3.2, 10.7.1, 10.8.1, 10.8.3, 10.8.4
Outdoor storage .....	15.3, 15.4
Per control area .....	9.6
Classification of occupancies exceeding ....	9.8, A.9.8.1, A.9.8.2
Special occupancy limits .....	9.6.2
Processing facilities .....	A.17.1.1
Storage occupancies .....	12.3.1, 12.3.2, 12.6, 12.6.2.2, 12.8, A.12.8.1, A.12.8.4
<b>Means of egress</b> .....	9.3.3
Detached buildings .....	13.3.3
Hazardous materials storage lockers .....	14.6.4
Liquid processing facilities .....	17.6.11, A.17.6.11
<b>Measure, units of</b> .....	1.6
<b>Mechanical equipment, friction heat or sparks from</b> .....	19.5.7.5, A.19.5.7.5
<b>Mercantile occupancies</b> .....	6.4.1 Ex. 3, Chap.10, 17.15.2 Ex. 3
Definition .....	3.3.39.9
Detached buildings, separation of .....	13.3.1, 13.3.2, A.13.3.1, A.13.3.2
Means of egress .....	9.3.3
<b>Mists</b> .....	1.1.2(6)
<b>Mobile foam apparatus</b> .....	6.7.9, 24.6.1.3

**-N-**

<b>Nonmetallic containers</b> .....	12.6.2.2
Definition .....	3.3.12.3, A.3.3.12.3
Fire protection systems .....	16.4.1.2, 16.4.1.3, 16.4.1, 16.5.2.5, 16.5.2.7, 16.5.2.12
Intermediate bulk containers (IBCs) .....	<i>see</i> Intermediate bulk containers (IBCs)
<b>Nonmetallic intermediate bulk containers (IBCs)</b> ....	<i>see</i> Intermediate bulk containers (IBCs)
<b>Nonmetallic portable tanks (capacity over 60 gal [230 L])</b>	
Definition .....	3.3.51.4.1, A.3.3.51.4.1
<b>Normal vents</b> .....	
Definition .....	3.3.60.2
Storage tanks .....	21.4.3, 23.6, A.21.4.3.2, A.21.4.3.11, A.23.6.1

**-O-**

<b>Occupancies</b>	
Ambulatory health care	
Definition .....	3.3.39.1
Maximum allowable quantities per control area .....	9.6.2.1, 9.6.2.2, 9.6.2.4

<b>Assembly</b>	
Definition .....	3.3.39.2
Maximum allowable quantities per control area .....	9.6.2.1, 9.6.2.2
<b>Business</b> .....	<i>see</i> Business occupancies
<b>Classification of</b>	
Definition .....	3.3.40
Maximum allowable quantities per control area, exceeding .....	9.8, A.9.8.1, A.9.8.2
Outdoor .....	<i>see also</i> Outdoor storage
Definition .....	3.3.40.1
Protection Level 2 .....	9.8.1, 9.8.2, A.9.8.1
<b>Day-care</b>	
Definition .....	3.3.39.4
Maximum allowable quantities per control area .....	9.6.2.1, 9.6.2.2, 9.6.2.4
Definition .....	3.3.39
<b>Detention and correctional</b>	
Definition .....	3.3.39.5
Maximum allowable quantities per control area .....	9.6.2.1, 9.6.2.2
<b>Educational</b>	
Definition .....	3.3.39.6
Maximum allowable quantities per control area .....	9.6.2.1, 9.6.2.2, 9.6.2.4
<b>Health care</b>	
Definition .....	3.3.39.7
Maximum allowable quantities per control area .....	9.6.2.1, 9.6.2.2, 9.6.2.4
<b>Industrial</b> .....	<i>see</i> Industrial occupancies
<b>Mercantile</b> .....	<i>see</i> Mercantile occupancies
<b>Residential</b>	
Definition .....	3.3.39.10
Maximum allowable quantities per control area .....	9.6.2.1
Residential board and care (definition) .....	3.3.39.11
Storage .....	<i>see</i> Storage occupancies
<b>Oil</b> .....	1.1.2(8), A.1.1.2(8); <i>see also</i> Boil-over
<b>Oil-fired heaters</b> .....	19.4.4, A.19.4.4
<b>Operating units (vessels) (definition)</b> .....	3.3.41
<b>Operations</b> .....	Chap. 6, Chap. 19; <i>see also</i> Dispensing of liquids
Definition .....	3.3.42
Detached, unprotected buildings .....	13.18
Emergency planning and training .....	6.8
Fire and explosion hazards, management and analysis of .....	6.3, 6.4, A.6.3, A.6.4.1.1, A.6.4.1.2
Fire protection .....	6.7, 19.4.6, A.6.7.1 to A.6.7.8, A.19.4.6.1
Ignition sources, control of .....	6.5, A.6.5.1(8) to A.6.5.4
Incidental operations .....	18.5, A.18.5.1 to A.18.5.6(3)
Inspection and maintenance .....	6.9
Liquid handling, transfer, and use .....	18.4, A.18.4.8
Loading and unloading .....	Chap. 28
Management of operation hazards .....	17.15
Mercantile occupancies .....	10.1.2, 10.8.2, 10.18
Recirculating heat transfer systems .....	19.4, A.19.4.2 to A.19.4.7.1
Solvent distillation units .....	19.6
Storage occupancies .....	12.14, 12.18
Vapor processing systems .....	<i>see</i> Vapor processing systems
Vapor recovery systems .....	<i>see</i> Vapor recovery systems
Wharves, at .....	Chap. 29
<b>Outdoor occupancy classification (definition)</b> .....	3.3.40.1
<b>Outdoor storage</b> .....	9.19, Chap. 15
Allowable quantities and storage height .....	15.3, 15.3.4, 15.4
Building, storage adjacent to .....	15.4
Detached, unprotected buildings .....	13.19
Electrical area classification .....	7.3.3
Mercantile occupancies .....	10.19
Separation .....	15.4.4, 15.4.5
Storage occupancies .....	12.19
<b>Outdoor tanks</b> .....	<i>see</i> Aboveground storage tanks
<b>Overfill protection</b>	
Secondary containment tanks .....	22.11.4.5
Storage tank buildings .....	24.14.8, A.24.14.8



Storage tanks ..... 19.5.6.1, 19.7.2.5, 21.7.1, A.19.7.2.5, A.21.7.1  
 Tank vehicles ..... 19.5.6.2, 28.11.1.6, 28.11.1.7  
 Vaults ..... 25.3.2.1  
**Overpack containers** ..... 9.1.3, 9.4.3.3  
**Overpressure/vacuum protection** ..... 19.5.2  
**Oxidizers, separation from** ..... 9.17.3

## -P-

**Petroleum, crude** ..... *see* Crude petroleum  
**Piers (definition)** ..... 3.3.43, A.3.3.43; *see also* Wharves  
**Piping systems** ..... Chap. 27; *see also* Valves  
 Common loading and unloading ..... 27.6.7  
 Corrosion, protection against ..... 27.6.4, A.27.6.4  
 Identification ..... 27.10, A.27.10  
 Installation of ..... 27.6, A.27.6.2, A.27.6.4  
 Joints ..... 27.5, A.27.5.1.2  
 Liquid processing operations ..... 18.4.4, 18.4.6, 18.5.2  
 Loading and unloading facilities ..... 28.10.1  
 Marine piping ..... 27.11  
 Materials ..... 27.4, A.27.4.3.2  
   Ductile iron ..... 27.4.2  
   Lining ..... 27.4.5  
   Low melting point ..... 27.4.4  
   Nonmetallic ..... 27.4.6  
 Penetrations ..... 27.6.3  
 Performance standards ..... 27.3.1  
 Recirculating heat transfer systems ..... 19.4.5, A.19.4.5.1, A.19.4.7.1  
 Remote impoundment or diked areas ..... 22.12.1, 22.12.2.1, 22.12.2.2, A.22.12.1  
 Removal from service ..... 27.12  
 Secondary containment ..... 27.7.2  
 Static electricity protection ..... 27.9  
 Supports ..... 27.6.1, 27.6.2, A.27.6.2  
 Testing ..... 27.7  
 Tightness of piping ..... 27.3.2  
 Underground ..... 27.6.4, 27.6.5, A.27.6.4  
 Vapor collection ..... 19.5.4.1  
 Vent pipes ..... 21.4.3.12, 27.8, A.27.8.1.6, A.27.8.2.1  
   Aboveground tanks ..... 22.7.4, A.22.7.4  
   Storage tank buildings ..... 24.13.6  
   Underground tanks ..... 23.6.2, 23.6.4  
   Vaults ..... 25.13.1  
 Wharves ..... 29.3.11 to 29.3.13  
**Pits** ..... 24.5.3, 24.10.5  
**Planning, emergency** ..... *see* Emergency planning and training  
**Plants, chemical (definition)** ..... 3.3.10  
**Plastic containers** ..... *see* Containers  
**Plastic intermediate bulk containers** ..... *see* Intermediate bulk containers (IBCs), nonmetallic  
**Portable tanks (capacity over 60 gal [230 L])**  
 Definition ..... 3.3.51.4  
 Nonmetallic (definition) ..... 3.3.51.4.1, A.3.3.51.4.1  
**Portable tanks (660 gal [2500 L] or less capacity)** ..... Chap. 9, Annex D  
 Acceptable ..... 9.4, A.9.4.1  
 Detached unprotected buildings ..... Chap. 13  
 Fire protection ..... 9.10, Annex D, Annex E; *see also* Inside storage, automatic fire protection systems for  
 Hazardous materials storage lockers ..... *see* Hazardous materials storage lockers  
 Incidental operations, liquids for ..... 18.5.4, A.18.5.4.1(1)  
 Industrial occupancies ..... Chap. 11  
 Mercantile occupancies ..... 10.1.3(1), 10.12.2  
 Metal ..... 9.4.3, 12.6.2.2, 16.2.3, 16.5.2.1 to 16.5.2.4, A.16.2.3  
 Outdoor storage ..... *see* Outdoor storage  
 Size, maximum ..... 9.4.3  
 Stacking ..... 9.3.9, A.9.3.9.3  
 Storage ..... *see also* Detached, unprotected buildings, storage in; Hazardous materials storage lockers; Inside liquid storage areas  
 Industrial occupancies ..... Chap. 11

Protected ..... 9.10, Annex D, Annex E; *see also* Inside storage, automatic fire protection systems for  
 Storage occupancies ..... Chap. 12  
 Transfer of liquids from/to ..... 9.1.2, 18.4.4, 18.5.2, 18.5.6, A.18.5.6(3)  
 Venting ..... 9.4.2  
**Portable tanks (over 793 gal [3000 L])** ..... *see* Aboveground storage tanks; Storage tanks  
**Pressure-relieving devices** ..... 19.7.5.4, 22.7.3, A.22.7.3.1 to A.22.7.3.10.4  
**Pressure vessels**  
 Atmospheric tanks, use as ..... 21.4.2.1.5  
 Definition ..... 3.3.44  
 Design standards ..... 21.4.2.3, A.21.4.2.3.2  
 Location of ..... 22.4.1.8  
 Low-pressure tanks, use as ..... 21.4.2.2.1, 21.4.2.2.3  
 Venting ..... 21.4.3.5 to 21.4.3.9  
**Process facilities, design and construction of** ..... Chap. 17  
 Accessibility ..... 17.5  
 Construction ..... 17.6, A.17.6.8 to A.17.6.11  
 Drainage ..... 17.10, A.17.10.1  
 Electrical equipment ..... 17.9  
 Location ..... 17.3.1, 17.4, A.17.3.1, A.17.4.3, A.17.4.6  
 Management of operation hazards ..... 17.15  
 Process equipment and vessels, accidental releases from ..... 17.14, A.17.14  
 Ventilation ..... 17.11, 17.15.4(4), A.17.11.2, A.17.11.7  
 Venting ..... 17.6.10, 17.6.13, A.17.6.10  
**Processing buildings** ..... *see* Process facilities, design and construction of  
**Process or processing** ..... Chap. 18; *see also* Operations; Process units (vessels)  
 Definition ..... 3.3.45, A.3.3.45  
 Fire prevention and explosion risk control ..... Chap. 6  
**Process units (vessels)** ..... *see also* Pressure vessels  
 Definition ..... 3.3.41, A.3.3.41  
 Emergency relief from ..... 6.4.1.1(2)  
 Location ..... 17.4, A.17.4.3, A.17.4.6  
 Transfer of liquids from/to ..... 18.4.4, 18.5.2  
**Protected storage** ..... *see* Storage  
**Protection for exposures (definition)** ..... 3.3.46; *see also* Separation  
**Pumps**  
 Electrical area classification ..... Table 7.3.3  
 Fire ..... 29.3.28.3  
 Liquid-processing equipment ..... 17.4.6  
 Liquid recovery ..... 25.9.2, 25.9.3  
 Liquid transfer ..... 18.4.5, 18.5.2.3, 19.7.5.4, 28.4.3, 28.10.1, 28.10.2, 29.3.9  
**Purpose of code** ..... 1.2, A.1.2

## -R-

**Reactive liquids, solvent distillation units** ..... 19.6.3.1  
**Recirculating heat transfer systems** ..... 19.4, A.19.4.2 to A.19.4.7.1  
**References** ..... Chap. 2, Annex I  
**Refineries (definition)** ..... 3.3.47  
**Residential board and care occupancies (definition)** ..... 3.3.39.11  
**Residential occupancies**  
 Definition ..... 3.3.39.10  
 Maximum allowable quantities per control area ..... 9.6.2.1  
**Retroactivity of code** ..... 1.4, A.1.4.2  
**Roofed structures, tank vehicle loading/unloading facilities** ..... 28.5  
**Roof tanks** ..... *see also* Floating roof tanks  
 Electrical area classification ..... 7.3.3  
 Extinguishing system ..... 22.8, A.22.8.1  
 Location ..... 22.4.1.4  
 Pontoons, inspection of ..... 22.17.4, A.22.17.4  
**Rooms, liquid storage** ..... *see* Liquid storage rooms

## -S-

**Safety cans** ..... 9.4.1, 9.4.3, 18.5.2(2), A.9.4.1  
 Definition ..... 3.3.48, A.3.3.48

<b>Scope of code</b> .....	1.1, A.1.1.1 to A.1.1.2(9)	Liquid processing operations .....	17.4.3
<b>Secondary containment</b> .....	A.14.1	Storage tanks	
Definition .....	27.2.5	Diking .....	22.11.2.6.3.1, 22.11.2.6.3.3
Piping .....	27.7.2	Emergency relief vents .....	22.7.3.5
<b>Secondary containment tanks</b> ...	21.5.2.7, 21.5.2.8, 22.11.4, A.21.5.2.7	Location .....	22.4.1.1, 22.4.1.3, 22.4.1.6
Definition .....	3.3.51.5	Spacing .....	22.4.2.1, A.22.4.2.1
<b>Security</b>		<b>Staging (definition)</b> .....	3.3.50
Hazardous materials storage lockers .....	14.5.5	<b>Standpipe and hose systems</b> .....	6.7.7, 24.6.1.2, A.24.6.1.2
Management of .....	6.10, Annex G	<b>Static electricity protection</b>	
Outdoor storage .....	15.3.6	Hazardous materials storage lockers .....	A.14.1
Storage tanks .....	21.7.2.2, A.21.7.2.2	Liquid processing operations .....	6.5.1(9), 6.5.4, 18.5.2.2, A.6.5.4
<b>Separation</b>		Loading and unloading facilities .....	28.11.1.5, 28.11.2.2, A.28.11.2.2, A.28.11.3, A.28.11.5
Detached, unprotected buildings		Vapor collection and processing equipment ...	19.5.7.3, A.19.5.7.3
Liquid storage from other storage .....	13.3.4, 13.3.6, 13.3.7	Wharves .....	29.3.24
From other buildings .....	13.3.1, 13.3.2, A.13.3.1, A.13.3.2	<b>Storage</b> .....	<i>see also</i> Control areas; Incidental liquid use or storage;
Hazardous materials storage lockers .....	14.5.2	Inside liquid storage areas; Outdoor storage; Storage	
From combustible materials .....	14.6.5	tanks; Warehouses	
Between individual lockers .....	14.5.2, 14.5.4	Aerosol products .....	1.1.2(5)
Liquid processing facilities .....	17.4, 17.6.1, 17.6.3, 17.6.4, A.17.4.3, A.17.4.6	Construction features .....	9.9
Mercantile occupancy control areas .....	10.9.1	Detached buildings .....	<i>see</i> Detached, unprotected buildings, storage in
Outdoor storage .....	15.3, 15.3.2 to 15.3.4, 15.3.7, 15.4.4, 15.4.5	Distilled liquids .....	19.6.5
Processing facilities/areas .....	17.4, 18.5.4, A.17.4.3, A.17.4.6, A.18.5.4.1(1)	Electrical systems .....	<i>see</i> Electrical systems
Storage tank buildings .....	24.4.2, 24.4.4 to 24.4.7, A.24.4.5(3)	Empty or idle pallets .....	12.3.9 to 12.3.11, 13.3.7, 14.6.5
Storage tanks		Explosion control .....	9.16, A.9.16.1, A.9.16.2
Aboveground .....	22.4.1, 22.4.2, 22.11.4.6, A.22.4.2.1	General requirements .....	Chap. 9
Cooking oil .....	19.7.3.1, A.19.7.3.1.1, A.19.7.3.1.2	Incompatible materials	
Underground tanks .....	23.4.2, 23.4.3	Separation from .....	9.17, 10.17
Transfer areas .....	18.5.6(1)	Tank construction materials, compatibility of .....	21.4.1.1, 21.4.1.4
Vaults .....	25.4	Industrial occupancies .....	Chap. 11
<b>Signs, warning</b>		Liquid processing operations .....	18.5.3, 18.5.4, A.18.5.4.1(1)
Hazardous materials storage lockers .....	14.6.6	Maximum allowable quantities per control area .....	9.6
Vaults .....	25.3.1.9	Mercantile occupancies .....	Chap. 10
<b>Smoking</b> .....	6.5.1(5), 6.5.2	Outdoor .....	<i>see</i> Outdoor storage
<b>Solvent distillation units</b> .....	19.6	Palletized, solid pile, or rack .....	9.3.5, A.9.3.9.3
Definition .....	3.3.49	Automatic fire protection .....	16.3.2, 16.3.3, 16.5.2, A.16.1.1, Annex D, Annex E; <i>see also</i> In-rack sprinklers
<b>Spillage</b> .....	<i>see also</i> Drainage; Impounding	Detached, unprotected buildings .....	13.3.4, 13.3.5, 13.6.2, 13.6.3
Aboveground tanks .....	22.11, A.22.11	Hazardous materials storage lockers .....	14.6.1
Hazardous materials storage lockers .....	14.4.8	Outdoor storage .....	15.3.1, 15.3.2, 15.3.4
Liquid handling, transfer, and use .....	6.6.2, 6.9.2, 18.4.2, 18.5.2.3, 18.5.6(2)	Storage occupancies .....	12.3.5 to 12.3.12, 12.6.2.2, 12.6.2.3, 12.8.2, 12.8.3, 12.8.5
Liquid storage areas .....	9.13, A.9.13	Protected .....	9.3.4, 9.10, 12.10, Annex D, Annex E; <i>see also</i> Inside storage, automatic fire protection systems for
Loading and unloading facilities .....	28.9, A.28.9	Definition .....	16.2.2
Mercantile occupancies .....	10.13	Storage occupancies .....	12.3.4 to 12.3.6, 12.3.9, 12.6.1
Outside storage .....	15.3.5	Spill control, drainage, and containment .....	9.13, A.9.13
Storage occupancies .....	12.13	Storage cabinets .....	9.5, A.9.5
Storage tanks .....	21.4.1.2(3)	Unprotected .....	12.3.5, 12.3.7, 12.3.8, 12.3.10, 12.6.2.2; <i>see also</i> Detached, unprotected buildings, storage in
Wharves .....	29.3.25, A.29.3.25	<b>Storage areas</b> .....	<i>see</i> Inside liquid storage areas
<b>Spill control</b>		<b>Storage cabinets</b> .....	9.5, 10.3.5, 10.8.4(3), A.9.5
Detached, unprotected buildings .....	13.13	<b>Storage lockers</b> .....	<i>see</i> Hazardous materials storage lockers
Storage tank buildings .....	24.9.5 to 24.9.9	<b>Storage occupancies</b> .....	Chap. 12
Vaults .....	25.9	Definition .....	3.3.39.12
<b>Spontaneous ignition</b> .....	19.5.7.4, A.19.5.7.4	Detached buildings, separation of .....	13.3.1, 13.3.2, A.13.3.1, A.13.3.2
<b>Sprays</b> .....	1.1.2(6)	<b>Storage tank buildings</b> .....	Chap. 24
<b>Sprinkler systems</b> ....	D.3 to D.5; <i>see also</i> Deluge systems; Foam-water sprinkler systems; In-rack sprinklers	Accessibility .....	24.4.8, 24.5.6, A.24.5.6
Containers and portable tanks .....	E.2.2, E.2.3.3, E.2.4.1, E.2.4.6, E.2.4.10, E.2.6.1, E.2.6.2	Construction .....	24.5, A.24.5.2 to A.24.5.6
Different classes of liquids stored in same area .....	16.3.1	Definition .....	3.3.8.2
Hazardous materials storage lockers .....	A.14.1	Detection and alarm systems .....	24.15
Inside storage .....	16.4, A.16.1.1	Drainage .....	24.9, A.24.9.6
Liquid processing facilities/operations .....	6.7.6, 6.7.7, 6.9.1, 17.6.7, 19.4.6.1, A.19.4.4, A.19.4.6.1	Electrical area classification .....	7.3.3
Mercantile occupancies .....	10.7.1, 10.8.4, 10.10.1	Inspection and maintenance .....	24.16
Sprinkler types .....	A.16.1.1, D.3	Location .....	24.4, A.24.4.5(3)
Storage occupancies .....	12.8.1, A.12.8.1	Openings (non-vent) .....	24.14, A.24.14.6, A.24.14.8
Storage tank buildings .....	24.6.1.2, 24.6.2.3, 24.6.2.4, 24.13.4, A.24.6.1.2, A.24.6.2.3	Overflow devices .....	24.14.8, A.24.14.8
<b>Stable liquids</b>		Vapor detection system .....	24.10.7
Definition .....	3.3.33.3	Venting .....	24.5.4, 24.13, A.24.5.4
Fire protection design criteria .....	16.5.1.1		



- Storage tanks** ..... Chap. 21; *see also* Aboveground storage tanks;  
Underground tanks
- Abandonment, closure, or removal ..... 21.7.4, A.21.7.4.1, A.21.7.4.3.3(2), Annex C
  - Buildings ..... *see* Storage tank buildings
  - Change of stored liquid ..... 21.9
  - Cooking oil, in commercial kitchens ..... 19.7, A.19.7.1.3 to A.19.7.5.2
  - Corrosion ..... 21.4.5, A.21.4.5
    - External ..... 23.3.5, A.23.3.5
    - Internal ..... 21.4.5, A.21.4.5
  - Definition ..... 3.3.51.6
  - Design and construction ..... 19.7.2, 19.7.5.1, 19.7.5.2, 21.3.2 to 21.3.5, 21.4, A.19.7.2.1.2 to A.19.7.2.6.2, A.19.7.5.1, A.19.7.5.2, A.21.4.2.1.1 to A.21.4.5
  - Electrical area classification ..... 7.3.3
  - Emergency planning and training ..... 21.6.4, 21.6.5, 21.7.3.3, A.21.6.5.1
  - Fire prevention and control ..... 21.6, A.21.6.5.1, A.21.6.6.1
  - Fire protection ..... 21.6, A.21.6.5.1, A.21.6.6.1
  - Flooding, in areas subject to ..... *see* Flooding
  - Heating ..... 19.7.2.6, A.19.7.2.6.1, A.19.7.2.6.2
  - Identification ..... 21.7.2, A.21.7.2.2
  - Ignition sources, control of ..... 21.6.2
  - Inspection and maintenance ..... 21.6.6, 21.8, A.21.6.6.1, A.21.8.1 to A.21.8.8, A.25.3.1
  - Materials ..... 21.4.1
  - Overfill protection ... 19.5.6.1, 19.7.2.5, 21.7.1, A.19.7.2.5, A.21.7.1
  - Piping systems ..... *see* Piping systems
  - Supports, foundations, and anchorage ..... 19.7.3.2, 22.5.1, 22.5.2, A.22.5.2.1, A.22.5.2.4
  - Testing ..... 19.7.3.4, 19.7.5.6, 21.5, 21.8.3, 21.8.5, A.19.7.3.4.1, A.21.5.2, A.21.5.3
  - Transfer of liquids from/to ..... 18.4.4, 18.5.2(4), 19.7.5, 28.10.1, A.19.7.5.1, A.19.7.5.2
- Storage tank vaults** ..... *see* Vaults
- Switch loading** ..... 28.11.3
- T-**
- Tanks**
- Fire-resistant ..... 22.9, 22.10.2(1)
  - Materials ..... 19.7.2.1, A.19.7.2.1.2
  - Portable ..... *see* Portable tanks
  - Pressure ..... *see* Pressure vessels
  - Storage ..... *see* Storage tanks
- Tank vehicles and cars, bulk loading and unloading** ..... 7.3.3, 19.5.6.2, Chap. 28
- Temporary removal of tank from service** ..... 21.7.4.3.2, Annex C
- Terminals (definition)** ..... 3.3.52
- Tests**
- Cargo hose ..... 29.3.10.1
  - Fire protection systems ..... 16.4.3
  - Fire test data, fire protection ..... Annex D, Annex E
  - Leak detection device ..... 28.10.2.1
  - Piping systems ..... 27.7
  - Storage tanks ..... 19.7.3.4, 19.7.5.6, 21.5, 21.8.3, 21.8.5, A.19.7.3.4.1, A.21.5.2, A.21.5.3
  - Tightness ..... 21.5.2, A.21.5.2
- Training**
- Emergency ..... *see* Emergency planning and training
  - Loading/unloading personnel ..... 28.11.4.1, A.28.11.4.1
- Transportation of liquids** ..... 1.1.2(7), A.1.1.2(7)
- U-**
- Underground piping** ..... 27.6.4, 27.6.5, A.27.6.4
- Underground tanks** ..... Chap. 23
- Abandonment or removal ..... Annex C
  - Aboveground use prohibited ..... 21.3.4
  - Bedding and backfill ..... 23.5.1
  - Burial depth and cover ..... 23.5.3, A.23.5.3.1
  - Closure, temporary or permanent ..... Annex C
  - Combustible materials, constructed of ..... 21.4.1.2(1)
  - Corrosion protection, external ..... 23.3.5, A.23.3.5
  - Disposal of ..... C.1, C.6
  - Electrical area classification ..... Table 7.3.3
  - Fill pipes ..... 23.13.3 to 23.13.6
  - Flooding, in areas subject to ..... 23.14, A.23.14.1
  - Inspection and maintenance ..... 23.17
  - Installation ..... 23.3.2, 23.5, A.23.5.3.1
    - Instructions ..... 23.16
  - Inventory records ..... 21.7.5, A.21.7.5
  - Leakage detection ..... 21.7.5, 28.10.2, A.21.7.5
  - Location ..... 23.4
  - Openings (non-vent) ..... 23.13, 23.14.1.2
  - Overfilling, prevention of ..... 21.7.1.5
  - Pumps, remote, in ..... 28.10.2
  - Removal ..... 21.7.4.3, A.21.7.4.3.3(2), C.1, C.5
  - Reuse ..... 21.7.4.3.8
  - Storage of removed ..... 21.7.4.3.5
  - Testing ..... 21.5.2, A.21.5.2
  - Venting ..... 23.6, 23.14.1.2, 27.8.2, A.23.6.1, A.27.8.2.1
- Unit operation or process (definition)** ..... 3.3.53
- Units of measure** ..... 1.6
- Unsaturated polyester resins (UPRs)** ..... 9.13.5, 16.5.2.11
  - Definition ..... 16.2.4, A.16.2.4
- Unstable liquids** ..... 9.3.2
  - Definition ..... 3.3.33.4, A.3.3.33.4
  - Explosion control ..... 9.16.2, A.9.16.2
  - Inside liquid storage areas ..... 16.1.2, A.16.1.2
  - Liquid processing operations ..... Table 17.4.3, 17.4.7, 17.6.13
  - Mercantile occupancies ..... 10.3.1
  - Solvent distillation units ..... 19.6.3.1
  - Storage tank buildings ..... 24.5.5
  - Storage tanks ..... 22.4.1.5, 22.4.2.2, 22.7.1.3, 22.11.2.6.3.4, 24.4.7, A.22.11.2.6.3.4
- V-**
- Vacuum protection** ..... 19.5.2
- Valves** ..... 18.4.6, 27.6.6, 29.3.11
  - Check ..... 27.6.6.3, 27.6.7
  - Isolation ..... 27.6.7
  - Materials for ..... 27.4.1, 27.4.3, A.27.4.3.2
  - Relief ..... 19.7.5.4, 29.3.9
  - Self-closing ..... 18.5.2(5), 28.11.1.6
  - Shutoff ..... 19.7.3.3.2, 28.11.1.6, 28.11.1.7, A.19.7.3.3.2
- Vapor collection systems** ..... 19.5.4
- Vapor control, tank vehicle** ..... 28.11.1.6.2, 28.11.1.8
- Vapor detection systems** ..... 24.10.7, 25.10.2, 25.15; *see also* Leakage detection and control
- Vaporizers** ..... 19.4.4, A.19.4.4
- Vapor pressure (definition)** ..... 3.3.54, 4.2.6, A.4.2.6
- Vapor processing equipment (definition)** ..... 3.3.55
- Vapor processing systems** ..... 19.5, A.19.5.5.1 to A.19.5.7.6
  - Definition ..... 3.3.56, A.3.3.56
- Vapor recovery systems** ..... 19.5, 23.13.6, 23.13.7, 24.14.9, A.19.5.5.1 to A.19.5.7.6
  - Definition ..... 3.3.57, A.3.3.57
- Vaportight** ..... 21.8.7, 22.7.3.2.1, 22.13.3, 23.13.1, 23.13.2, 23.13.6.1, 23.13.7.2, 24.14.6, 24.14.9.2, 25.13.2, A.24.14.6
  - Definition ..... 3.3.58
- Vaults** ..... Chap. 25
  - Containment, drainage, and spill control ..... 25.9
  - Definition ..... 3.3.59
  - Design and construction ..... 25.3.1.2, 25.5, A.25.5
  - Electrical systems ..... 7.3.3, 25.8
  - Exhaust ventilation system ..... 25.10
  - Fire protection ..... 25.6
  - Inspection and maintenance ..... 25.16
  - Location ..... 25.4
  - Tank appurtenances ..... 25.3.2
  - Tank selection and arrangement ..... 25.3.1, A.25.3.1
  - Vapor and liquid detection systems ..... 25.10.2, 25.15

<b>Ventilation</b> .....	A.14.1
Definition .....	3.3.61, A.3.3.61
Detached, unprotected buildings .....	13.14
Dispensing areas .....	18.6, A.18.6.3
Electrical equipment and installations .....	7.3.7.1
Emergency planning .....	6.8.1(4)
Fugitive emissions .....	Annex F
Hazardous materials storage lockers .....	14.4.7
Incidental operations .....	18.5.6(3), A.18.5.6(3)
Inside liquid storage areas .....	9.14, 10.14
Mercantile occupancies .....	10.14
Processing buildings .....	17.11, 17.15.4(4), A.17.11.2, A.17.11.7
Storage cabinets .....	9.5.4, A.9.5, A.9.5.4
Storage occupancies .....	12.14
Storage tank buildings .....	24.10, A.24.10.2, A.24.10.4
Storage tanks, cooking oil .....	19.7.4.2, 19.7.4.3, A.19.7.4.2
Vaults .....	25.10
<b>Vents</b> .....	<i>see also</i> Piping systems, Vent pipes
Aboveground tanks .....	<i>see</i> Aboveground storage tanks
Containers .....	9.4.2
Deflagration .....	<i>see</i> Deflagration venting
Electrical area classification .....	7.3.3
Emergency relief .....	<i>see</i> Emergency relief vents
Liquid processing facilities .....	17.6.10, 17.6.13, A.17.6.10
Maintenance .....	21.8.6, A.21.8.6
Normal	
Definition .....	3.3.60.2
Storage tanks .....	21.4.3, 23.6, A.21.4.3.2, A.21.4.3.11, A.23.6.1
Storage cabinets .....	9.5.4.1, 9.5.4.2, A.9.5.4
Storage tank buildings .....	24.5.4, 24.13, A.24.5.4
Storage tanks .....	<i>see</i> Storage tanks
Testing .....	21.5.1.2
Vapor processing systems .....	19.5.2, 19.5.3
Vaults .....	25.13
<b>Vessels, pressure</b> .....	<i>see</i> Pressure vessels
<b>Violent rupture</b> .....	E.2
<b>Viscous liquids</b>	
Automatic fire protection for .....	16.3.4
Definition .....	16.2.5

**-W-**

<b>Warehouses</b> .....	<i>see also</i> Liquid warehouses
Definition .....	A.3.3.62
Electrical area classification .....	7.3.3
General-purpose .....	12.3.1, 12.3.2, 12.8, A.12.8.1, A.12.8.4
Definition .....	3.3.62.1
<b>Waste control and disposal</b> .....	6.9.3, 6.9.4, 15.3.7
<b>Water-based fire protection systems</b> ....	6.9.1, 22.12.4; <i>see also</i> Deluge systems; Foam-water sprinkler systems; Sprinkler systems; Water spray systems
<b>Water loading</b> .....	21.7.3.1
<b>Water-miscible liquids</b> .....	9.1.4, 16.4.1.1, 16.4.1.3, 16.4.1, 16.5.2, D.3, D.4
In aboveground storage tanks .....	22.7.3.6, A.22.7.3.6
Definition .....	3.3.33.5, 16.2.6, A.3.3.33.5
Mercantile occupancies .....	10.1.3(4)
Storage occupancies .....	12.8.4 Ex. 1
Tank vehicle and tank car loading/unloading facilities .....	28.10.1(1)
<b>Water mist systems</b> .....	16.9
<b>Water-reactive materials, separation from</b> .....	9.17.4
<b>Water spray systems</b> .....	6.7.6, 16.9
Aboveground storage tanks .....	22.7.3.5, 22.7.3.7, A.22.7.3.7
Liquid processing facilities .....	17.6.8(4)
Storage tank buildings .....	24.6.2.3, 24.6.2.4, A.24.6.2.3
<b>Water supply</b>	
Extinguishing systems .....	16.7
To fill tanks in flood areas .....	21.7.3.1, 22.14.4
Fire protection .....	9.10.2.6
Inside liquid storage areas .....	16.5.1.12
Liquid processing facilities .....	6.7.2, 6.7.3, A.6.7.3
Storage tank buildings .....	24.6.2.1
Wharves .....	29.3.28, A.29.3.28
<b>Wharves</b>	
Definition .....	3.3.63, A.3.3.63
Electrical area classification .....	7.3.3
<b>Wood dust suspension-fired heaters</b> .....	19.4.4, A.19.4.4

# NFPA 30

## Flammable and Combustible Liquids Code

2015 Edition

**Reference:** 1.1, Scope

**F.I. 84-4**

**Background:** Tank trailers and semi-trailers are loaded with flammable or combustible liquid and moved to a storage yard. There, the tank vehicles may be kept for days, weeks, or months before being shipped to another location or being moved to another part of the same plant site. Some of the tank vehicles are not road-worthy.

**Question:** Do such tank vehicles, used for the temporary storage of flammable and combustible liquids, need to meet the requirements of NFPA 30 for drainage, impoundment, separation distances, etc.?

**Answer:** Yes.

**Issue Edition:** 1984

**Reference:** 1-1

**Date:** April 1987

Formal Interpretation

# NFPA 30

## Flammable and Combustible Liquids Code

2015 Edition

**Reference:** 1.1.1, 1.1.2(1)

**F.I. 93-1**

**Question:** Since the term “solid” is not defined by NFPA 30, is it the intent of Subsections 1.1.1 and 1.1.2(1) of NFPA 30 that a combustible material, having a melting point at or above 100°F, be outside the scope of NFPA 30 and exempt from NFPA 30’s requirements?

**Answer:** Yes.

**Issue Edition:** 1993

**Reference:** 1.1, 1-1.3, 5-4.1.1

**Issue Date:** March 7, 1995

**Effective Date:** March 27, 1995

Formal Interpretation

# NFPA 30

## Flammable and Combustible Liquids Code

2015 Edition

**Reference: 3.3.6**

**F.I. 81-1**

**Question:** Is it the intent of NFPA 30 that Fuel Oil #6 be considered a boil-over liquid, as per the definition of boil-over, viz., crude oil (or certain other liquids) and as per the applicability of Table 22.4.1.4 of NFPA 30 governing boil-over liquids?

**Answer:** No.

**Issue Edition: 1981**

**Reference: 1-2**

**Date: April 1981**



# NFPA 30

## Flammable and Combustible Liquids Code

2015 Edition

**Reference:** Table 7.3.3

**F.I. No.** 30-03-1

**Background:** In Table 7.3.3, the electrical area classification for “Office and rest rooms”, “Garages for other than tank vehicles”, and “Indoor warehousing where there is no flammable liquid transfer” is listed as “Ordinary”, i.e., no area classification applies. However, each of these three entries includes a qualifying statement that reads “If there is any opening to these rooms within the extent of an indoor classified location, the room shall be classified the same as if the wall, curb, or partition did not exist”.

**Question:** Is it the intent of the qualifying statement to require that the classified area extend through the opening(s) only to the distance specified by Table 7.3.3 for the specific source(s) that requires area classification?

**Answer:** Yes.

**Issue Edition:** 2003

**Reference:** Table 8.2.2

**Issue Date:** May 8, 2006

**Effective Date:** May 28, 2006

# NFPA 30

## Flammable and Combustible Liquids Code

2015 Edition

**Reference: Section 9.4**

**F.I. 90-2**

**Background:** An intermediate bulk container (IBC), that is constructed of a blow-molded plastic bottle, of 61 to 660 gallons capacity, that is structurally supported by a metal overpack and is attached to a pallet. The plastic overpack provides primary liquid containment. The sheet metal overpack provides structural rigidity and impact protection, but is not liquid-tight.

**Question:** Does a container such as described meet the intent of the phrase “approved metal portable tank” as cited in Section 9.4 of NFPA 30?

**Answer:** No.

**Issue Edition: 1990**

**Reference: 4-2**

**Issue Date: January 22, 1991**

**Effective Date: February 11, 1991**

# NFPA 30

## Flammable and Combustible Liquids Code

2015 Edition

**Reference: Chapter 24**

**F.I. 90-1**

**Background:** Hydraulic elevator systems commonly use low-pressure tanks as accumulator reservoirs to contain the hydraulic oil that is pumped into and out of the hydraulic cylinder. The question has arisen whether these reservoirs are subject to the provisions of NFPA 30, specifically the provisions of Chapter 24. Specific provisions for such accumulator tanks are not mentioned in any other code, including the ANSI standards that deal specifically with elevator systems.

**Question:** Are the hydraulic accumulator reservoirs of a hydraulic elevator system subject to the provisions of NFPA 30, Chapter 24, Storage Tank Buildings?

**Answer:** No.

**Issue Edition: 1990**

**Reference: 2-5**

**Issue Date: January 22, 1991**

**Effective Date: February 11, 1991**

Formal Interpretation

# NFPA 30

## Flammable and Combustible Liquids Code

2015 Edition

**Reference:** 27.6.6

**F.I.** N/A

**Question:** Does the requirement for check valves for automatic protection against back-flow in 27.6.6 apply to marine unloading facilities?

**Answer:** Paragraphs 29.3.9 through 29.3.13 are applicable to marine flammable and combustible liquids wharves at bulk plants and provide exceptions and additions to Chapter 27, including 27.6.6. Use of check valves in tanker and barge unloading lines is not mandatory, but 29.3.11(4) requires the installation of block valves to control flow in the event of physical damage.

**Issue Edition:** 1976

**Reference:** 3-6.1

**Issue Date:** January, 1978

**Reissued:** January, 1994

# NFPA 30

## Flammable and Combustible Liquids Code

2015 Edition

**Reference:** Table A.16.1.1(b)  
**F.I. 84-3**

**Question 1:** Does the column in Table A.16.1.1(b), headed “Maximum Quantity of Containers (gal)” apply to the total quantity allowed in a single rack?

**Answer:** Yes.

**Question 2:** Does the column in Table A.16.1.1(b), headed “Maximum Quantity of Containers (gal)” also apply to the total quantity allowed in the entire fire area?

**Answer:** Yes.

**Issue Edition:** 1984

**Reference:** Table 4-6.1(b)

**Issue Date:** April 1987

**Effective Date:** August 1995

## Sequence of Events for the Standards Development Process

As soon as the current edition is published, a Standard is open for Public Input

### Step 1: Input Stage

- Input accepted from the public or other committees for consideration to develop the First Draft
- Committee holds First Draft Meeting to revise Standard (23 weeks)  
Committee(s) with Correlating Committee (10 weeks)
- Committee ballots on First Draft (12 weeks)  
Committee(s) with Correlating Committee (11 weeks)
- Correlating Committee First Draft Meeting (9 weeks)
- Correlating Committee ballots on First Draft (5 weeks)
- First Draft Report posted

### Step 2: Comment Stage

- Public Comments accepted on First Draft (10 weeks)
- If Standard does not receive Public Comments and the Committee does not wish to further revise the Standard, the Standard becomes a Consent Standard and is sent directly to the Standards Council for issuance
- Committee holds Second Draft Meeting (21 weeks)  
Committee(s) with Correlating Committee (7 weeks)
- Committee ballots on Second Draft (11 weeks)  
Committee(s) with Correlating Committee (10 weeks)
- Correlating Committee First Draft Meeting (9 weeks)
- Correlating Committee ballots on First Draft (8 weeks)
- Second Draft Report posted

### Step 3: Association Technical Meeting

- Notice of Intent to Make a Motion (NITMAM) accepted (5 weeks)
- NITMAMs are reviewed and valid motions are certified for presentation at the Association Technical Meeting
- Consent Standard bypasses Association Technical Meeting and proceeds directly to the Standards Council for issuance
- NFPA membership meets each June at the Association Technical Meeting and acts on Standards with “Certified Amending Motions” (certified NITMAMs)
- Committee(s) and Panel(s) vote on any successful amendments to the Technical Committee Reports made by the NFPA membership at the Association Technical Meeting

### Step 4: Council Appeals and Issuance of Standard

- Notification of intent to file an appeal to the Standards Council on Association action must be filed within 20 days of the Association Technical Meeting
- Standards Council decides, based on all evidence, whether or not to issue the Standards or to take other action

## Committee Membership Classifications<sup>1,2,3,4</sup>

The following classifications apply to Committee members and represent their principal interest in the activity of the Committee.

1. M *Manufacturer*: A representative of a maker or marketer of a product, assembly, or system, or portion thereof, that is affected by the standard.
2. U *User*: A representative of an entity that is subject to the provisions of the standard or that voluntarily uses the standard.
3. IM *Installer/Maintainer*: A representative of an entity that is in the business of installing or maintaining a product, assembly, or system affected by the standard.
4. L *Labor*: A labor representative or employee concerned with safety in the workplace.
5. RT *Applied Research/Testing Laboratory*: A representative of an independent testing laboratory or independent applied research organization that promulgates and/or enforces standards.
6. E *Enforcing Authority*: A representative of an agency or an organization that promulgates and/or enforces standards.
7. I *Insurance*: A representative of an insurance company, broker, agent, bureau, or inspection agency.
8. C *Consumer*: A person who is or represents the ultimate purchaser of a product, system, or service affected by the standard, but who is not included in (2).
9. SE *Special Expert*: A person not representing (1) through (8) and who has special expertise in the scope of the standard or portion thereof.

NOTE 1: “Standard” connotes code, standard, recommended practice, or guide.

NOTE 2: A representative includes an employee.

NOTE 3: While these classifications will be used by the Standards Council to achieve a balance for Technical Committees, the Standards Council may determine that new classifications of member or unique interests need representation in order to foster the best possible Committee deliberations on any project. In this connection, the Standards Council may make such appointments as it deems appropriate in the public interest, such as the classification of “Utilities” in the National Electrical Code Committee.

NOTE 4: Representatives of subsidiaries of any group are generally considered to have the same classification as the parent organization.

## **Submitting Public Input / Public Comment through the Electronic Submission System (e-Submission):**

As soon as the current edition is published, a Standard is open for Public Input.

Before accessing the e-Submission System, you must first sign-in at [www.NFPA.org](http://www.NFPA.org). *Note: You will be asked to sign-in or create a free online account with NFPA before using this system:*

- a. Click in the gray Sign In box on the upper left side of the page. Once signed-in, you will see a red “Welcome” message in the top right corner.
- b. Under the Codes and Standards heading, Click on the Document Information pages (List of Codes & Standards), and then select your document from the list or use one of the search features in the upper right gray box.

*OR*

- a. Go directly to your specific document page by typing the convenient short link of [www.nfpa.org/document#](http://www.nfpa.org/document#), (Example: NFPA 921 would be [www.nfpa.org/921](http://www.nfpa.org/921)) Click in the gray Sign In box on the upper left side of the page. Once signed in, you will see a red “Welcome” message in the top right corner.

To begin your Public Input, select the link The next edition of this standard is now open for Public Input (formally “proposals”) located on the Document Information tab, the Next Edition tab, or the right-hand Navigation bar. Alternatively, the Next Edition tab includes a link to Submit Public Input online

At this point, the NFPA Standards Development Site will open showing details for the document you have selected. This “Document Home” page site includes an explanatory introduction, information on the current document phase and closing date, a left-hand navigation panel that includes useful links, a document Table of Contents, and icons at the top you can click for Help when using the site. The Help icons and navigation panel will be visible except when you are actually in the process of creating a Public Input.

Once the First Draft Report becomes available there is a Public comment period during which anyone may submit a Public Comment on the First Draft. Any objections or further related changes to the content of the First Draft must be submitted at the Comment stage.

To submit a Public Comment you may access the e-Submission System utilizing the same steps as previous explained for the submission of Public Input.

For further information on submitting public input and public comments, go to: <http://www.nfpa.org/publicinput>

### **Other Resources available on the Doc Info Pages**

**Document information tab:** Research current and previous edition information on a Standard

**Next edition tab:** Follow the committee’s progress in the processing of a Standard in its next revision cycle.

**Technical committee tab:** View current committee member rosters or apply to a committee

**Technical questions tab:** For members and Public Sector Officials/AHJs to submit questions about codes and standards to NFPA staff. Our Technical Questions Service provides a convenient way to receive timely and consistent technical assistance when you need to know more about NFPA codes and standards relevant to your work. Responses are provided by NFPA staff on an informal basis.

**Products/training tab:** List of NFPA’s publications and training available for purchase.

**Community tab:** Information and discussions about a Standard

## Information on the NFPA Standards Development Process

**I. Applicable Regulations.** The primary rules governing the processing of NFPA standards (codes, standards, recommended practices, and guides) are the NFPA *Regulations Governing the Development of NFPA Standards (Regs)*. Other applicable rules include NFPA *Bylaws*, NFPA *Technical Meeting Convention Rules*, NFPA *Guide for the Conduct of Participants in the NFPA Standards Development Process*, and the NFPA *Regulations Governing Petitions to the Board of Directors from Decisions of the Standards Council*. Most of these rules and regulations are contained in the *NFPA Standards Directory*. For copies of the *Directory*, contact Codes and Standards Administration at NFPA Headquarters; all these documents are also available on the NFPA website at “[www.nfpa.org](http://www.nfpa.org).”

The following is general information on the NFPA process. All participants, however, should refer to the actual rules and regulations for a full understanding of this process and for the criteria that govern participation.

**II. Technical Committee Report.** The Technical Committee Report is defined as “the Report of the responsible Committee(s), in accordance with the Regulations, in preparation of a new or revised NFPA Standard.” The Technical Committee Report is in two parts and consists of the First Draft Report and the Second Draft Report. (See *Regs* at 1.4)

**III. Step 1: First Draft Report.** The First Draft Report is defined as “Part one of the Technical Committee Report, which documents the Input Stage.” The First Draft Report consists of the First Draft, Public Input, Committee Input, Committee and Correlating Committee Statements, Correlating Input, Correlating Notes, and Ballot Statements. (See *Regs* at 4.2.5.2 and Section 4.3) Any objection to an action in the First Draft Report must be raised through the filing of an appropriate Comment for consideration in the Second Draft Report or the objection will be considered resolved. [See *Regs* at 4.3.1(b)]

**IV. Step 2: Second Draft Report.** The Second Draft Report is defined as “Part two of the Technical Committee Report, which documents the Comment Stage.” The Second Draft Report consists of the Second Draft, Public Comments with corresponding Committee Actions and Committee Statements, Correlating Notes and their respective Committee Statements, Committee Comments, Correlating Revisions, and Ballot Statements. (See *Regs* at Section 4.2.5.2 and 4.4) The First Draft Report and the Second Draft Report together constitute the Technical Committee Report. Any outstanding objection following the Second Draft Report must be raised through an appropriate Amending Motion at the Association Technical Meeting or the objection will be considered resolved. [See *Regs* at 4.4.1(b)]

**V. Step 3a: Action at Association Technical Meeting.** Following the publication of the Second Draft Report, there is a period during which those wishing to make proper Amending Motions on the Technical Committee Reports must signal their intention by submitting a Notice of Intent to Make a Motion. (See *Regs* at 4.5.2) Standards that receive notice of proper Amending Motions (Certified Amending Motions) will be presented for action at the annual June Association Technical Meeting. At the meeting, the NFPA membership can consider and act on these Certified Amending Motions as well as Follow-up Amending Motions, that is, motions that become necessary as a result of a previous successful Amending Motion. (See 4.5.3.2 through 4.5.3.6 and Table1, Columns 1-3 of *Regs* for a summary of the available Amending Motions and who may make them.) Any outstanding objection following action at an Association Technical Meeting (and any further Technical Committee consideration following successful Amending Motions, see *Regs* at 4.5.3.7 through 4.6.5.3) must be raised through an appeal to the Standards Council or it will be considered to be resolved.

**VI. Step 3b: Documents Forwarded Directly to the Council.** Where no Notice of Intent to Make a Motion (NITMAM) is received and certified in accordance with the Technical Meeting Convention Rules, the standard is forwarded directly to the Standards Council for action on issuance. Objections are deemed to be resolved for these documents. (See *Regs* at 4.5.2.5)

**VII. Step 4a: Council Appeals.** Anyone can appeal to the Standards Council concerning procedural or substantive matters related to the development, content, or issuance of any document of the Association or on matters within the purview of the authority of the Council, as established by the *Bylaws* and as determined by the Board of Directors. Such appeals must be in written form and filed with the Secretary of the Standards Council (See *Regs* at 1.6). Time constraints for filing an appeal must be in accordance with 1.6.2 of the *Regs*. Objections are deemed to be resolved if not pursued at this level.

**VIII. Step 4b: Document Issuance.** The Standards Council is the issuer of all documents (see Article 8 of *Bylaws*). The Council acts on the issuance of a document presented for action at an Association Technical Meeting within 75 days from the date of the recommendation from the Association Technical Meeting, unless this period is extended by the Council (See *Regs* at 4.7.2). For documents forwarded directly to the Standards Council, the Council acts on the issuance of the document at its next scheduled meeting, or at such other meeting as the Council may determine (See *Regs* at 4.5.2.5 and 4.7.4).

**IX. Petitions to the Board of Directors.** The Standards Council has been delegated the responsibility for the administration of the codes and standards development process and the issuance of documents. However, where extraordinary circumstances requiring the intervention of the Board of Directors exist, the Board of Directors may take any action necessary to fulfill its obligations to preserve the integrity of the codes and standards development process and to protect the interests of the Association. The rules for petitioning the Board of Directors can be found in the *Regulations Governing Petitions to the Board of Directors from Decisions of the Standards Council* and in 1.7 of the *Regs*.

**X. For More Information.** The program for the Association Technical Meeting (as well as the NFPA website as information becomes available) should be consulted for the date on which each report scheduled for consideration at the meeting will be presented. For copies of the First Draft Report and Second Draft Report as well as more information on NFPA rules and for up-to-date information on schedules and deadlines for processing NFPA documents, check the NFPA website ([www.nfpa.org/aboutthecodes](http://www.nfpa.org/aboutthecodes)) or contact NFPA Codes & Standards Administration at (617) 984-7246.